



MICRO SWITCH

# KH-9012



## CLASSIFICATION

**KH - 9012 - 5 HLL**

① ② ③

① TYPE NUMBER	9012	Micro switch Type V	Micro switch Type V
② CONTACT RATING	NONE	125VAC, 15A (Resistance load)	
	5	125VAC, 5A (Resistance load)	
③ ACTUATOR	PB	Pin plunger	
	HL	Short hinge lever	
	HLL	Long hinge lever	
	HLR	Hinge lever Round type	
	HRL	Long hinge roller lever	
	HRM	Hinge roller lever	
	HRS	Short hinge roller lever	

Rated Voltage	Resistive Load				Inductive Load				Motor Load			
	KH-9012-5		KH-9012		KH-9012-5		KH-9012		KH-9012-5		KH-9012	
	NC	NO	NC	NO	NC	NO	NC	NO	NC	NO	NC	NO
125VAC	5A	5A	15A	15A	3A	3A	10A	10A	1.5A	0.7A	4A	2A
250VAC	3A	3A	10A	10A	2A	2A	5A	5A	1.0A	0.5A	2.5A	1.2A
8VDC	5A	5A	15A	15A	3A	3A	10A	10A	-	-	-	-
14VDC	5A	5A	15A	15A	3A	3A	8A	8A	-	-	-	-
30VDC	5A	5A	6A	6A	3A	3A	4A	4A	-	-	-	-
125VDC	0.6A	0.6A	0.6A	0.6A	0.1A	0.1A	0.3A	0.3A	-	-	-	-
250VDC	0.3A	0.3A	0.3A	0.3A	0.05A	0.05A	0.1A	0.1A	-	-	-	-



CONTROL COMPONENTS

SQUARE LIGHT

TOWER LIGHT

MICRO SWITCH

FOOT SWITCH

LIMIT SWITCH

POWER SWITCH

HOIST SWITCH

CAM SWITCH

BUZZER

PHOTO SENSOR

PROXIMITY SENSOR

FLOATLESS LEVEL SWITCH

TIMER & COUNTER









RELAY









SOCKETS

TERMINAL BLOCK

CONTROL BOX

PID TEMP. CONTROLLER

Model	Model	OF Max.	PT Max	MD Max.	OT min.	OP	Material
KH-9012-5PBC		250g	1.6mm	1.0mm	0.3mm	14.7mm ± 0.7	Enclosure: PBT glass
KH-9012-5HLC		250g	1.6mm	0.8mm	0.3mm	15.3mm ± 0.6	Enclosure: PBT glass Lever: Stainless steel
KH-9012-5HLLC		150g	4.0mm	1.6mm	0.6mm	15.3mm ± 1.6	Enclosure: PBT glass Lever: Stainless steel
KH-9012-5HRLC		150g	4.0mm	1.6mm	0.6mm	20.7mm ± 1.6	Enclosure: PBT glass Lever: Stainless steel Roller: Brass(Ni plated)
KH-9012-5HRMC		150g	4.0mm	1.6mm	0.6mm	20.6mm ± 1.6	Enclosure: PBT glass Lever: Stainless steel Roller: Brass(Ni plated)
KH-9012-5HRSC		250g	1.6mm	0.8mm	0.3mm	20.6mm ± 1.2	Enclosure: PBT glass Lever: Stainless steel Roller: Brass(Ni plated)
KH-9012-5HLRC		150g	4.0mm	1.6mm	0.6mm	18.3mm ± 1.6	Enclosure: PBT glass Lever: Stainless steel
KH-9012-5PBFC		250g	1.6mm	0.8mm	0.3mm	14.7mm ± 0.7	Enclosure: PBTglass

Model	Model	OF Max.	PT Max	MD Max.	OT min.	OP	Material
KH-9012-PBC		500g	1.6mm	1.0mm	0.3mm	14.7mm ± 0.7	Enclosure: PBT glass
KH-9012-HLC		600g	1.6mm	1.5mm	0.3mm	15.3mm ± 0.6	Enclosure: PBT glass Lever: Stainless steel
KH-9012-HLLC		300g	4.0mm	3.0mm	0.6mm	15.3mm ± 1.6	Enclosure: PBT glass Lever: Stainless steel
KH-9012-HRLC		300g	4.0mm	3.0mm	0.6mm	20.7mm ± 1.6	Enclosure: PBT glass Lever: Stainless steel Roller: Brass(Ni plated)
KH-9012-HRMC		400g	4.0mm	3.0mm	0.6mm	20.6mm ± 1.6	Enclosure: PBT glass Lever: Stainless steel Roller: Brass(Ni plated)
KH-9012-HRSC		600g	1.6mm	1.5mm	0.3mm	20.6mm ± 1.0	Enclosure: PBT glass Lever: Stainless steel Roller: Brass(Ni plated)
KH-9012-HLRC		300g	4.0mm	3.0mm	0.6mm	18.3mm ± 1.6	Enclosure: PBT glass Lever: Stainless steel
KH-9012-PBFC		500g	1.6mm	1.0mm	0.3mm	14.7mm ± 0.7	Enclosure: PBT glass



Reference

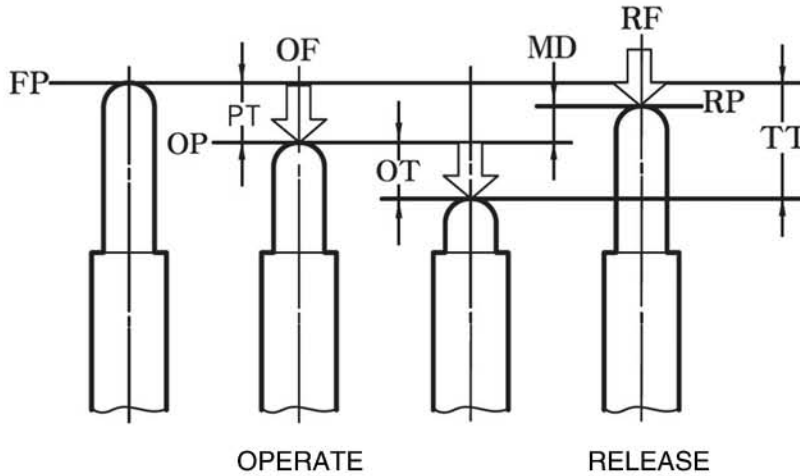

OF	Required force to actuate	Required force to move from free position (FP) to operating position (OP)
RF	Return force	Required force to return from total travel position (TTP) to return position (RP)
PT	Movement to actuation	Distance or angle of movement from free position (FP) to operating position (OP)
MD	Movement differential	Distance or angle of movement from operating position (OP) to return position (RP)
OT	Movement after actuation	Distance or angle of movement from operating position (OP) to total travel position (TTP)
OP	Operating position	Actuator position when a contact point (NO (normal open)) is actuated (On) at free position (FP).
FP	Free position	Actuator position when no external force is applied to actuator
TTP	Total travel position	Actuator position when actuator arrives at stop.
RP	Return position	Actuator when a contact point (NO) is off at operating position (OP).
TT	Entire movement	Distance or angle of movement from free position (FP) to total travel position (TTP).

CONTROL COMPONENTS

SQUARE LIGHT

TOWER LIGHT

MICRO SWITCH

FOOT SWITCH

LIMIT SWITCH

POWER SWITCH

HOIST SWITCH

CAM SWITCH

BUZZER

PHOTO SENSOR

PROXIMITY SENSOR

FLOATLESS LEVEL SWITCH

TIMER & COUNTER

RELAY

SOCKETS

TERMINAL BLOCK

CONTROL BOX

PID TEMP. CONTROLLER

Dimension

V2F1P01C (KH-9012-5PB(C))

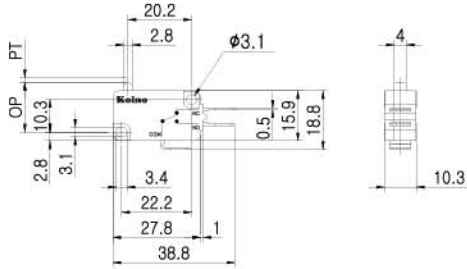

V2F1L05C (KH-9012-5HL(C))

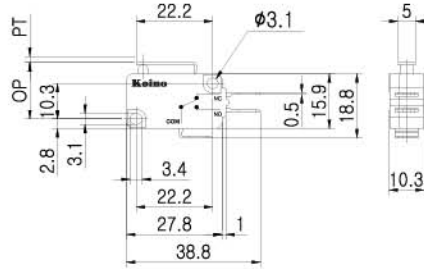

V2F1L01C (KH-9012-5HL(LC))

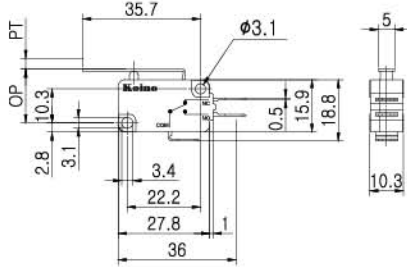

V2F1L01(R)C (KH-9012-5HL(R)C)

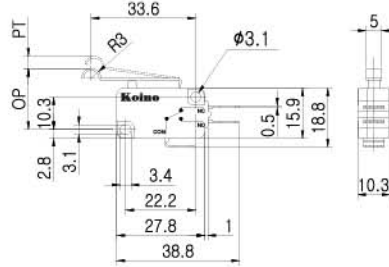

V2F1L04C (KH-9012-5HR(M)C)

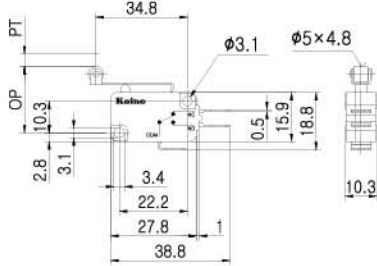

V2F1L07C (KH-9012-5HR(S)C)

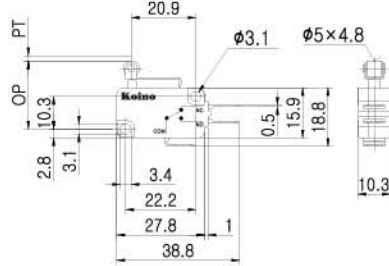

V2F1P01C (KH-9012-5PB(F)C)

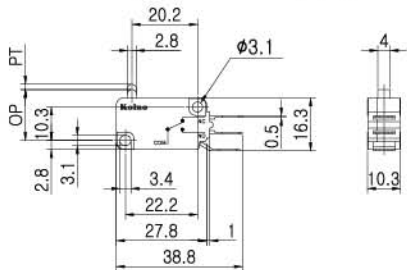

V2F1L03C (KH-9012-5HR(L)C)

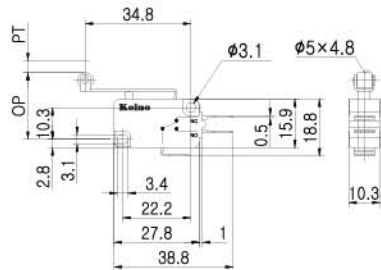

CONTROL COMPONENTS

SQUARE LIGHT

TOWER LIGHT

**MICRO SWITCH**

FOOT SWITCH

LIMIT SWITCH

POWER SWITCH

HOIST SWITCH

CAM SWITCH

BUZZER

PHOTO SENSOR

PROXIMITY SENSOR

FLOATLESS LEVEL SWITCH

TIMER & COUNTER

RELAY

SOCKETS

TERMINAL BLOCK

CONTROL BOX

PID TEMP. CONTROLLER

V4F1P01C (KH-9012-PB(C))

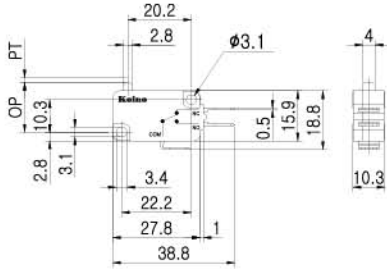

V4F1L05C (KH-9012-HL(C))

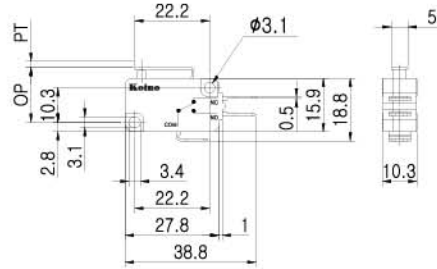

V4F1L01C (KH-9012-HL(L)C)

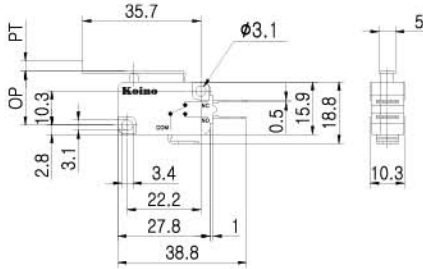

V4F1L03C (KH-9012-HR(L)C)

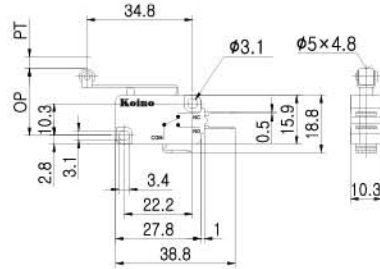

V4F1L04C (KH-9012-HR(M)C)

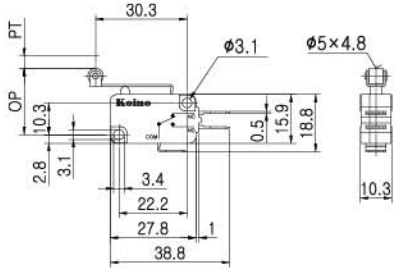

V4F1L07C (KH-9012-HR(S)C)

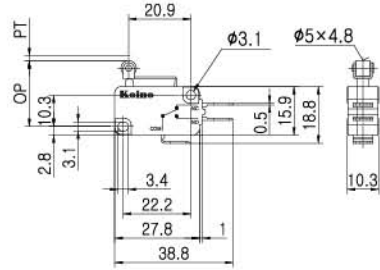

V4F1P01C (KH-9012-PB(F)C)

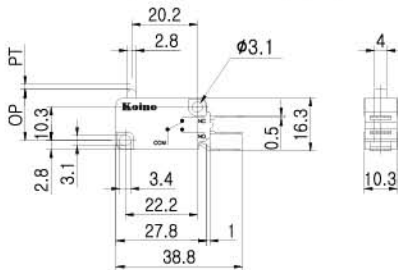

V4F1L01(R)C (KH-9012-HL(R)C)

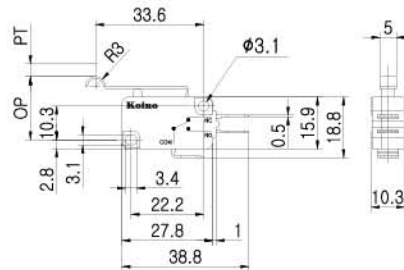

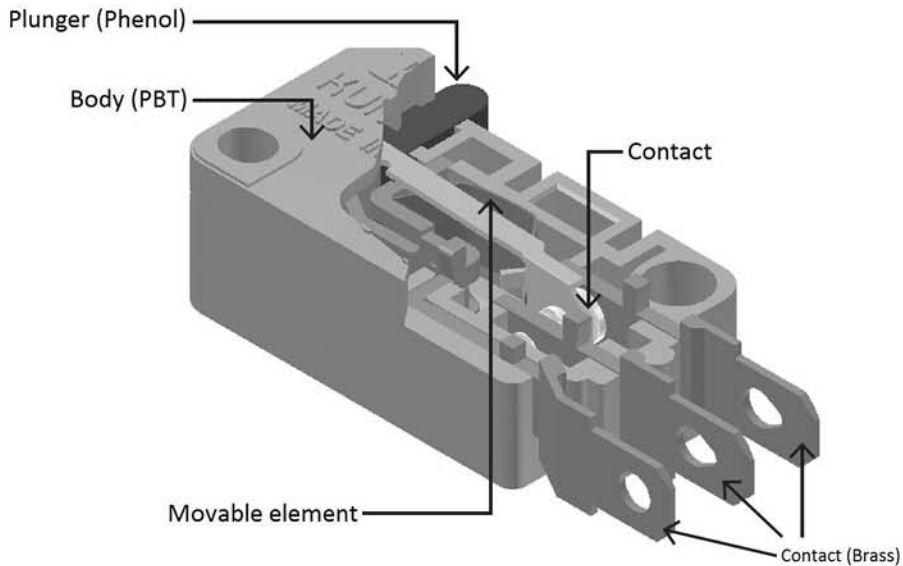

## Technical Information

Allowed Operating Velocity		0.1mm/s~1mm/s
Operating Frequency	Mechanical	240 operations/minute
Operating Frequency	Electrical	20 operations/minute
Insulation Resistance		100M $\Omega$ min. (DC500V)
Contact Resistance		15m $\Omega$ Max.
Dielectric Strength	Between live parts	1,000VAC(50/60Hz) for 1 minute
	Between dead parts	1,500VAC(50/60Hz) for 1 minute
Vibration Resistance	Malfunction	10~55Hz double amplitude 1.5mm, X,Y,Z at each direction
Shock Resistance	Destruction	100G
	Malfunction	5G
Durability	Mechanical	1,000,000 operations
	Electrical	100,000 operations
Protection		IP40
Ambient Temperature		-25~+80°C (not freezing condition)
Ambient Humidity		45~85% RH
Weight		6.2~10.5g