

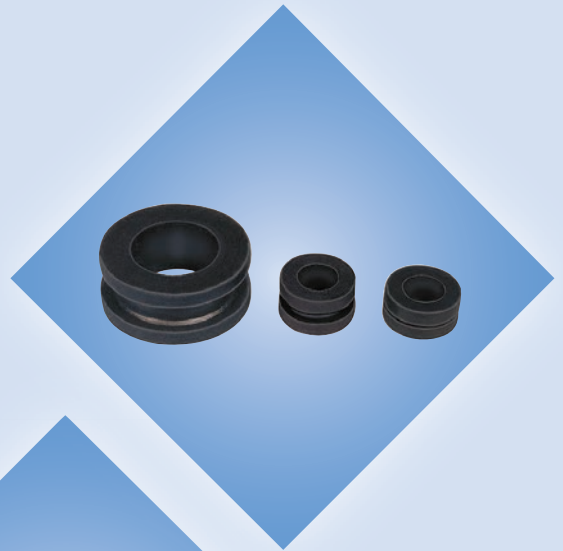

A20

HELAVIA grommets and mouldings in polychloroprene rubber





SES-STERLING has modern sophisticated conversion equipment backed by our research laboratory keeping us at the forefront of technology. Design and manufacture of the moulds plus full maintenance facilities give us control of production at all stages.

A large proportion of our manufacturing capacity is devoted to the moulding of Neoprene elastomer, which has properties of particular relevance to the electrical industry.

The main properties are:

- very good resistance to ageing
- good ozone resistance
- good electrical insulation
- exceptional flexibility
- fair resistance to oils
- available in varying degrees of flexibility from 40 to 70 Shore hardness A

SES-STERLING has many years experience in moulding Polychloroprene.

SES-STERLING is synonymous with guarantee of quality.

SES-STERLING sells polychloroprene grommets branded HELAVIA®.

SES-STERLING can supply you with following standard moulded parts from stock:

- Grommets in different forms**
- Membrane grommets**
- Reinforced grommets**
- Wire-clamp grommets**
- Wire protector grommets**
- Caps**
- Feet**
- Flanged and bushed grommets in specific shapes**
- Special grommets**

With our know-how, we can adapt any specific demand on the material (silicone, EPDM, ...) and colors (white, gray,).

Universal grommets DU in EPDM rubber



DU

Material:	EPDM
Colour:	black
Operating temperatures:	-40 to +100°C
Ultimate elongation:	> 400 %
Dielectric strength:	> 13 kV/mm
Resistance to ozone:	very good
Specification:	halogene free

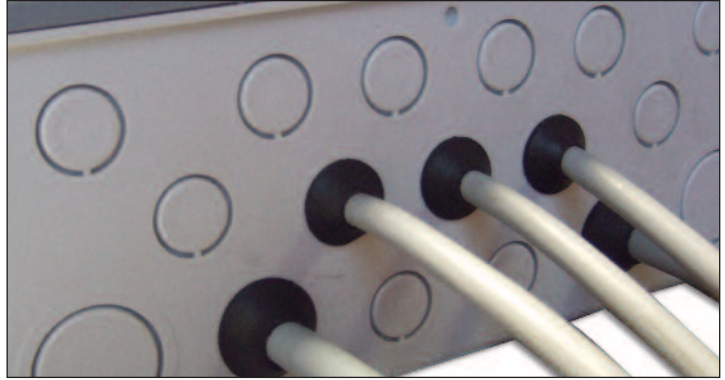

type	artide number	dimensions (mm)						pcs
		Ø A	Ø B	Ø C	D	F1	F2	
DU-M20	0252 0653 010	8-13	20	25,5	1...4	6,2	8	100
DU-M25	0252 0654 010	10-17	25	31	1...4	6,2	10,5	100

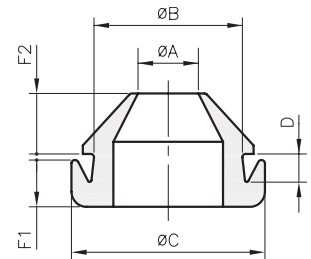

Specification: only one grommet adapting to a wall thickness of 1 to 4 mm.

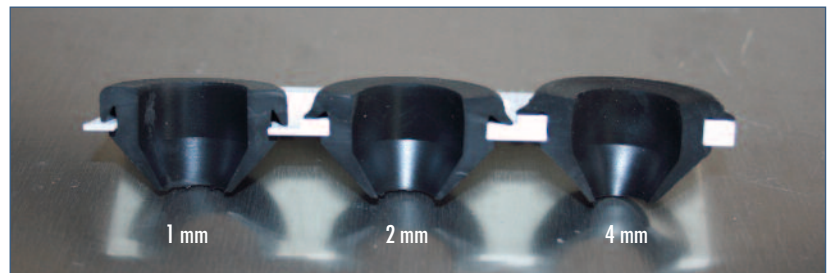

Mounting principle

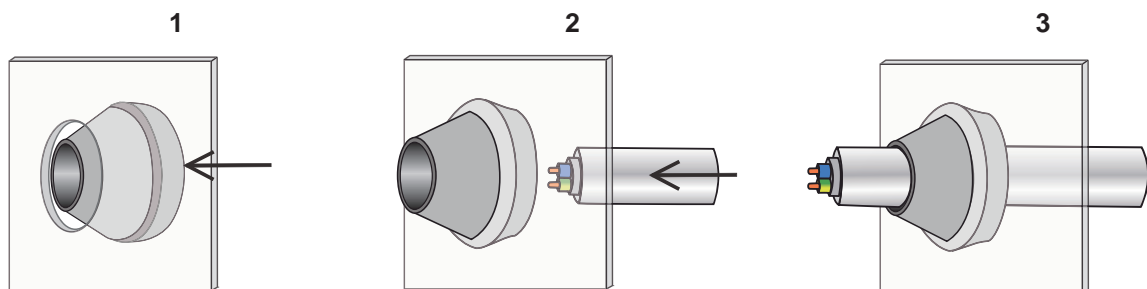

HELAVIA® standard grommets DA in black polychloroprene rubber (Neoprene)



HELAVIA®



DA

Material: polychloroprene rubber
Colour: black
Operating temperatures: -30 to +90°C
Tensile strength at break: > 7 MPa
Ultimate elongation: > 400 %
Dielectric strength: > 13 kV/mm



type	article number	dimensions (mm)						pcs
		Ø A	Ø B	Ø C	D	F1	F2	
DA 20/65/10	0252 0001 010	2	6,5	11	1	2	2	100
DA 20/65/15	0252 0002 010	2	6,5	11	1,5	2	2	100
DA 20/65/20	0252 0003 010	2	6,5	11	2	2	2	100
DA 20/80/10	0252 0004 010	2	8	11	1	2	2	100
DA 20/80/15	0252 0005 010	2	8	11	1,5	2	2	100
DA 20/80/20	0252 0006 010	2	8	11	2	2	2	100
DA 30/50/10	0252 0101 010	3	5	10	1	1,5	3	100
DA 30/70/10	0252 0135 010	3	7	10	1	1,5	3	100
DA 30/70/15	0252 0136 010	3	7	10	1,5	1,5	3	100
DA 30/70/20	0252 0137 010	3	7	10	2	1,5	3	100
DA 30/70/30	0252 0138 010	3	7	10	3	1,5	3	100
DA 30/70/35	0252 0102 010	3	7	10	3,5	1,5	3	100
DA 40/65/10	0252 0010 010	4	6,5	11	1	2	2	100
DA 40/80/10	0252 0007 010	4	8	11	1	2	2	100
DA 40/80/15	0252 0008 010	4	8	11	1,5	2	2	100
DA 40/80/20	0252 0009 010	4	8	11	2	2	2	100
DA 45/95/10	0252 0085 010	4,5	9,5	13	1	4,5	4,5	100
DA 45/95/15	0252 0086 010	4,5	9,5	13	1,5	4,5	4,5	100
DA 45/95/20	0252 0087 010	4,5	9,5	13	2	4,5	4,5	100
DA 48/80/10	0252 0139 010	4,8	8	12	1	1,5	1,5	100
DA 48/80/15	0252 0140 010	4,8	8	12	1,5	1,5	1,5	100
DA 48/80/20	0252 0141 010	4,8	8	12	2	1,5	1,5	100
DA 48/80/30	0252 0142 010	4,8	8	12	3	1,5	1,5	100
DA 48/85/30	0252 0011 010	4,8	8,5	12	3	1,5	1,5	100
DA 50/70/10	0252 0130 010	5	7	11	1	2,8	2,8	100
DA 50/70/15	0252 0131 010	5	7	11	1,5	2,8	2,8	100
DA 50/70/20	0252 0132 010	5	7	11	2	2,8	2,8	100
DA 50/70/30	0252 0152 010	5	7	11	3	2,8	2,8	100
DA 50/90/10	0252 0171 010	5	9	15	1	3	8	100
DA 50/90/15	0252 0172 010	5	9	15	1,5	3	8	100
DA 50/90/20	0252 0173 010	5	9	15	2	3	8	100
DA 50/90/30	0252 0174 010	5	9	15	3	3	8	100
DA 55/80/10	0252 0013 010	5,5	8	11	1	2	2	100
DA 55/80/15	0252 0014 010	5,5	8	11	1,5	2	2	100
DA 55/80/20	0252 0015 010	5,5	8	11	2	2	2	100
DA 58/100/15	0252 0016 010	5,8	10	16	1,5	3,8	3,8	100

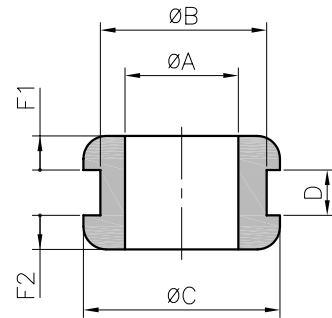

HELAVIA® standard grommets DA in black polychloroprene rubber (Neoprene)



HELAVIA®



type	article number	dimensions (mm)						pcs
		Ø A	Ø B	Ø C	D	F1	F2	
DA 60/90/10	0252 0133 010	6	9	14	1	3	3	100
DA 60/90/15	0252 0017 010	6	9	14	1,5	3	3	100
DA 60/90/20	0252 0134 010	6	9	14	2	3	3	100
DA 60/90/30	0252 0153 010	6	9	14	3	3	3	100
DA 60/90/40	0252 0178 010	6	9	14	4	3	3	100
DA 60/100/10	0252 0018 010	6	10	14	1	3	3	100
DA 60/100/15	0252 0019 010	6	10	14	1,5	3	3	100
DA 60/100/20	0252 0020 010	6	10	14	2	3	3	100
DA 60/100/30	0252 0021 010	6	10	14	3	3	3	100
DA 60/100/40	0252 0373 010	6	10	14	4	3	3	100
DA 60/110/10	0252 0022 010	6	11	16	1	1,8	1,8	100
DA 60/110/15	0252 0023 010	6	11	16	1,5	1,8	1,8	100
DA 60/110/20	0252 0024 010	6	11	16	2	1,8	1,8	100
DA 60/110/30	0252 0143 010	6	11	16	3	1,8	1,8	100
DA 60/110/50	0252 0154 010	6	11	14	5	3	3	100
DA 60/120/10	0252 0144 010	6	12	16	1	1,8	1,8	100
DA 60/120/15	0252 0145 010	6	12	16	1,5	1,8	1,8	100
DA 60/120/20	0252 0146 010	6	12	16	2	1,8	1,8	100
DA 60/120/30	0252 0025 010	6	12	16	3	1,8	1,8	100
DA 70/120/10	0252 0147 010	7	12	16	1	3,3	3,3	100
DA 70/120/15	0252 0148 010	7	12	16	1,5	3,3	3,3	100
DA 70/120/20	0252 0088 010	7	12	16	2	3,3	3,3	100
DA 70/120/30	0252 0149 010	7	12	16	3	3,3	3,3	100
DA 75/110/50	0252 0110 010	7,5	11	20	5	3,5	3,5	100
DA 75/120/10	0252 0089 010	7,5	12	20	1	3,5	3,5	100
DA 75/120/15	0252 0090 010	7,5	12	20	1,5	3,5	3,5	100
DA 75/120/20	0252 0091 010	7,5	12	20	2	3,5	3,5	100
DA 75/120/30	0252 0092 010	7,5	12	20	3	3,5	3,5	100
DA 75/120/60	0252 0026 010	7,5	12	20	6	3,5	3,5	100
DA 80/100/10	0252 0027 010	8	10	15	1	3,5	3,5	100
DA 80/100/15	0252 0028 010	8	10	15	1,5	3,5	3,5	100
DA 80/100/20	0252 0029 010	8	10	15	2	3,5	3,5	100
DA 80/100/30	0252 0030 010	8	10	15	3	3,5	3,5	100
DA 80/100/40	0252 0031 010	8	10	15	4	3,5	3,5	100
DA 80/110/10	0252 0155 010	8	11	15	1	3,5	3,5	100
DA 80/110/15	0252 0032 010	8	11	15	1,5	3,5	3,5	100
DA 80/110/20	0252 0033 010	8	11	15	2	3,5	3,5	100
DA 80/110/30	0252 0156 010	8	11	15	3	3,5	3,5	100
DA 80/110/40	0252 0157 010	8	11	15	4	3,5	3,5	100
DA 80/160/60	0252 0175 010	8	16	20	6	3	3	100
DA 90/110/10	0252 0036 010	9	11	16	1	2,8	2,8	100
DA 90/110/15	0252 0037 010	9	11	16	1,5	2,8	2,8	100
DA 90/110/20	0252 0038 010	9	11	16	2	2,8	2,8	100
DA 90/110/30	0252 0039 010	9	11	16	3	2,8	2,8	100
DA 90/110/40	0252 0040 010	9	11	16	4	2,8	2,8	100
DA 90/160/10	0252 0158 010	9	16	22	1	4	4	100
DA 90/160/15	0252 0041 010	9	16	22	1,5	4	4	100
DA 90/160/20	0252 0159 010	9	16	22	2	4	4	100
DA 90/160/30	0252 0160 010	9	16	22	3	4	4	100
DA 90/160/40	0252 0161 010	9	16	22	4	4	4	100

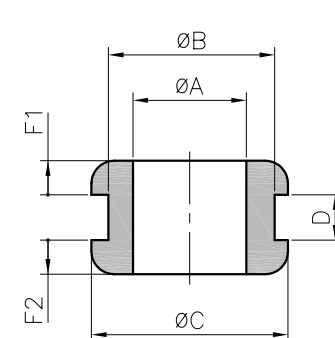

HELAVIA® standard grommets DA in black polychloroprene rubber (Neoprene)



HELAVIA®



type	article number	dimensions (mm)						pieces
		Ø A	Ø B	Ø C	D	F1	F2	
DA 90/200/20	0252 0042 010	9	20	27	2	3,3	3,3	100
DA 90/200/30	0252 0043 010	9	20	27	3	3,3	3,3	100
DA 90/200/40	0252 0044 010	9	20	27	4	3,3	3,3	100
DA 95/130/10	0252 0045 010	9,5	13	17,5	1	3	3	100
DA 95/130/15	0252 0046 010	9,5	13	17,5	1,5	3	3	100
DA 95/130/20	0252 0047 010	9,5	13	17,5	2	3	3	100
DA 95/130/30	0252 0048 010	9,5	13	17,5	3	3	3	100
DA 95/130/40	0252 0049 010	9,5	13	17,5	4	3	3	100
DA 95/130/50	0252 0050 010	9,5	13	17,5	5	3	3	100
DA 95/130/80	0252 0051 010	9,5	13	17,5	8	3	3	100
DA 95/140/20	0252 0179 010	9,5	14	17,5	2	3	3	100
DA 100/140/10	0252 0180 010	10	14	20	1	2	2	100
DA 100/140/15	0252 0181 010	10	14	20	1,5	2	2	100
DA 100/140/20	0252 0182 010	10	14	20	2	2	2	100
DA 100/140/25	0252 0183 010	10	14	20	2,5	2	2	100
DA 100/140/30	0252 0184 010	10	14	20	3	2	2	100
DA 100/160/15	0252 0083 010	10	16	20	1,5	2	2	100
DA 110/140/10	0252 0093 010	11	14	19	1	3	3	100
DA 110/140/15	0252 0052 010	11	14	19	1,5	3	3	100
DA 110/140/20	0252 0094 010	11	14	19	2	3	3	100
DA 110/140/30	0252 0095 010	11	14	19	3	3	3	100
DA 110/150/10	0252 0053 010	11	15	19	1	3	3	100
DA 110/150/15	0252 0054 010	11	15	19	1,5	3	3	100
DA 110/150/20	0252 0055 010	11	15	19	2	3	3	100
DA 110/150/25	0252 0056 010	11	15	19	2,5	3	3	100
DA 110/150/30	0252 0057 010	11	15	19	3	3	3	100
DA 120/180/10	0252 0162 010	12	18	25	1	2,5	2,5	100
DA 120/180/15	0252 0163 010	12	18	25	1,5	2,5	2,5	100
DA 120/180/20	0252 0164 010	12	18	25	2	2,5	2,5	100
DA 120/180/30	0252 0165 010	12	18	25	3	2,5	2,5	100
DA 120/180/40	0252 0166 010	12	18	25	4	2,5	2,5	100
DA 120/200/10	0252 0167 010	12	20	25	1	2,5	2,5	100
DA 120/200/15	0252 0168 010	12	20	25	1,5	2,5	2,5	100
DA 120/200/20	0252 0169 010	12	20	25	2	2,5	2,5	100
DA 120/200/30	0252 0170 010	12	20	25	3	2,5	2,5	100
DA 120/200/40	0252 0058 010	12	20	25	4	2,5	2,5	100
DA 120/280/80	0252 0177 010	12	28	40	8	4	4	100
DA 120/255/80	0252 0176 010	12	25,5	40	8	4	4	100
DA 130/170/10	0252 0151 010	13	17	23	1	4	4	100
DA 130/170/15	0252 0059 010	13	17	23	1,5	4	4	100
DA 130/170/20	0252 0060 010	13	17	23	2	4	4	100
DA 130/170/30	0252 0061 010	13	17	23	3	4	4	100
DA 130/170/40	0252 0062 010	13	17	23	4	4	4	100
DA 130/170/50	0252 0069 010	13	17	23	5	4	4	100
DA 130/170/60	0252 0063 010	13	17	23	6	4	4	100
DA 140/200/10	0252 0064 010	14	20	28	1	4	4	100
DA 140/200/15	0252 0065 010	14	20	28	1,5	4	4	100
DA 140/200/20	0252 0066 010	14	20	28	2	4	4	100
DA 140/200/30	0252 0067 010	14	20	28	3	4	4	100
DA 140/200/40	0252 0068 010	14	20	28	4	4	4	100

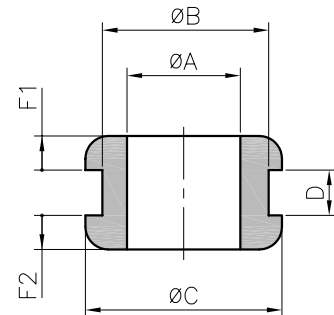

HELAVIA® standard grommets DA in black polychloroprene rubber (Neoprene)



HELAVIA®



type	article number	dimensions (mm)						pcs
		Ø A	Ø B	Ø C	D	F1	F2	
DA 150/220/10	0252 0096 010	15	22	26	1	4,5	4,5	100
DA 150/220/15	0252 0097 010	15	22	26	1,5	4,5	4,5	100
DA 150/220/20	0252 0098 010	15	22	26	2	4,5	4,5	100
DA 150/220/30	0252 0099 010	15	22	26	3	4,5	4,5	100
DA 150/220/80	0252 0070 010	15	22	26	8	4,5	4,5	100
DA 160/220/10	0252 0071 010	16	22	29,5	1	4	4	100
DA 160/220/15	0252 0072 010	16	22	29,5	1,5	4	4	100
DA 160/220/20	0252 0073 010	16	22	29,5	2	4	4	100
DA 160/220/30	0252 0074 010	16	22	29,5	3	4	4	100
DA 185/250/10	0252 0343 010	18,5	25	32,5	1	4,5	4,5	100
DA 185/250/15	0252 0075 010	18,5	25	32,5	1,5	4,5	4,5	100
DA 185/250/20	0252 0344 010	18,5	25	32,5	2	4,5	4,5	100
DA 185/250/25	0252 0345 010	18,5	25	32,5	2,5	4,5	4,5	100
DA 185/250/30	0252 0346 010	18,5	25	32,5	3	4,5	4,5	100
DA 185/250/40	0252 0347 010	18,5	25	32,5	4	4,5	4,5	100
DA 200/280/10	0252 0150 010	20	28	36	1	5	5	50
DA 200/280/15	0252 0076 010	20	28	36	1,5	5	5	50
DA 200/280/20	0252 0077 010	20	28	36	2	5	5	50
DA 200/280/30	0252 0078 010	20	28	36	3	5	5	50
DA 200/280/40	0252 0079 010	20	28	36	4	5	5	50
DA 200/280/60	0252 0080 010	20	28	36	6	5	5	50
DA 230/300/20	0252 0186 010	23	30	38	2	3,5	3,5	50
DA 230/300/30	0252 0187 010	23	30	38	3	3,5	3,5	50
DA 230/300/40	0252 0188 010	23	30	38	4	3,5	3,5	50
DA 230/300/60	0252 0189 010	23	30	38	6	3,5	3,5	50
DA 250/470/15	0252 0081 010	25	47	56,5	1,5	4,5	4,5	50
DA 300/350/10	0252 0330 010	30	35	40	1	4	4	50
DA 300/350/15	0252 0331 010	30	35	40	1,5	4	4	50
DA 300/350/20	0252 0332 010	30	35	40	2	4	4	50
DA 300/350/30	0252 0333 010	30	35	40	3	4	4	50
DA 300/350/40	0252 0334 010	30	35	40	4	4	4	50
DA 480/600/20	0252 0335 010	48	60	68	2	3,8	3,8	25
DA 480/600/25	0252 0082 010	48	60	68	2,5	3,8	3,8	25
DA 480/600/30	0252 0336 010	48	60	68	3	3,8	3,8	25
DA 480/600/40	0252 0337 010	48	60	68	4	3,8	3,8	25
DA 480/600/60	0252 0338 010	48	60	68	6	3,8	3,8	25

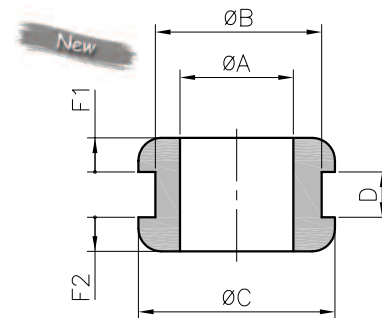

• HELAVIA standard grommets DC

type	article number	dimensions (mm)					pces
		Ø A	Ø B	Ø C	D	F	
DC 51/70/15	0252 0213 010	5,1	7	11	1,5	3	100
DC 70/250/60	0252 0220 010	7	25	29	6	2	100
DC 90/110/10	0252 0201 010	9	11	16	1	3,3	100
DC 90/110/15	0252 0202 010	9	11	16	1,5	3,3	100
DC 90/110/20	0252 0203 010	9	11	16	2	3,3	100
DC 90/110/30	0252 0204 010	9	11	16	3	3,3	100
DC 90/110/40	0252 0212 010	9	11	16	4	3,3	100
DC 190/250/65	0252 0206 010	19	25	32	6,5	3	50
DC 190/250/135	0252 0207 010	19	25	32	13,5	3	50
DC 940/1010/30	0252 0211 010	94	101	109	3	5,5	25

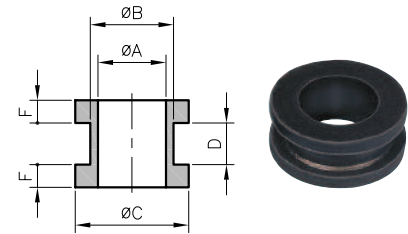

• Grommets with unequal sides series DC

type	article number	dimensions (mm)							pces
		Ø A	Ø B	Ø C	D	F 1	F 2		
DC 50/70/10	0252 0214 010	5	7	11	1	2	3,5	100	

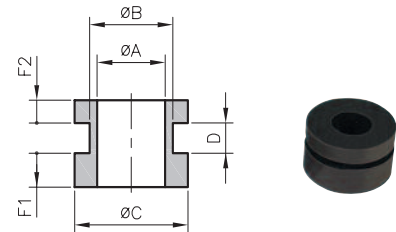

• Conical grommets series DE

type	article number	dimensions (mm)							pces
		Ø A	Ø B	Ø C	D	F 1	F 2		
DE 65/100/10	0252 0299 010	6,5	10	16/14	1	3	5	100	
DE 65/100/15	0252 0308 010	6,5	10	16/14	1,5	3	5	100	
DE 65/100/20	0252 0304 010	6,5	10	16/14	2	3	5	100	
DE 65/100/30	0252 0300 010	6,5	10	16/14	3	3	5	100	

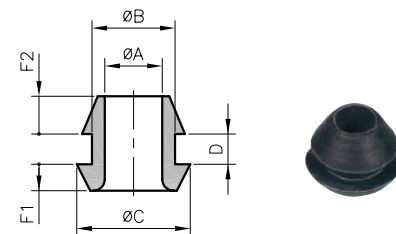

• Elongated grommets series DH

type	article number	dimensions (mm)					pces
		Ø A	Ø B	Ø C	D	F	
DH 60/90/80	0252 0340 010	6	9	14	8	3	100
DH 80/115/50	0252 0321 010	8	11,5	16	5	4	100
DH 80/115/80	0252 0322 010	8	11,5	16	8	4	100
DH 80/115/160	0252 0323 010	8	11,5	16	16	4	100
DH 120/200/200	0252 0326 010	12	20	27,5	20	5	50
DH 130/200/150	0252 0328 010	13	20	28	15	5	100
DH 140/200/200	0252 0327 010	14	20	28	20	5	50
DH 240/300/350	0252 0324 010	24	30	38	35	5	25
DH 250/310/330	0252 0320 010	25	31	37	33	5	25
DH 300/390/400	0252 0329 010	30	39	55	40	10	25
DH 350/450/500	0252 0341 010	35	45	57	50	10	25

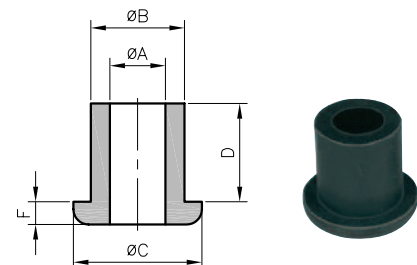

HELAVIA® membrane grommets DG in black polychloroprene rubber



HELAVIA®



DG HELAVIA

Material: polychloroprene rubber
Colours: black - grey (near RAL 7037)
Operating temperatures: -30 to +90°C
Tensile strength at break: 7 MPa
Ultimate elongation: > 400 %
Dielectric strength: > 13 kV/mm
Applications: designed to close off unused entries in panels, enclosures and housings of all types. Wires and conduits can pass through the membrane if required.

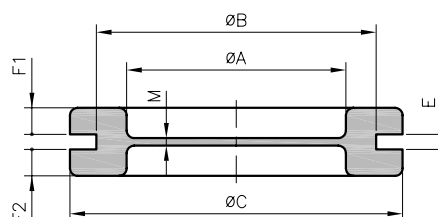

• Standard membrane (1 and 1,5 mm)

type	article number		dimensions (mm)							pcs
	black 010	grey 013	Ø A	Ø B	Ø C	E	F1	F2	M	
DG 9/E1	0258 0361 010	-	9	15,5	20	1	3,5	2,5	1	100
DG 9	0258 0351 010	0258 0351 013	9	15,5	20	2	2,5	2,5	1	100
DG 11	0258 0352 010	0258 0352 013	11	18,5	23	2	2,5	2,5	1	100
DG 13,5	0258 0353 010	0258 0353 013	13,5	20,5	25	2	2,5	2,5	1	100
DG 16	0258 0354 010	0258 0354 013	16	22,5	27,5	2	2,5	2,5	1	100
DG 21	0258 0355 010	0258 0355 013	21	28	35	2	3	3	1	100
DG 29	0258 0356 010	-	29	37	44	2	3,5	3,5	1	50
DG 36	0258 0357 010	-	36	47	54	2,5	3,8	3,8	1	50
DG 48	0258 0358 010	-	48	60	68	2,5	3,8	3,8	1	50
DG 53	0258 0359 010	-	53	64	75	2,5	3,8	3,8	1,5	50
DG 69	0258 0360 010	-	69	79	90	2,5	3,8	3,8	1,5	50
DG M16	0258 0011 010	-	9	16	20	2	2,5	2,5	1	100
DG M20	0258 0012 010	0258 0012 013	13,5	20	25	2	2,5	2,5	1	100
DG M25	0258 0013 010	0258 0013 013	18,5	25	30,5	2	2,5	2,5	1	100
DG M32	0258 0014 010	0258 0014 013	25	32	39	2	3	3	1	100
DG M40	0258 0015 010	-	31	40	47	2,5	3,8	3,8	1	50
DG M50	0258 0016 010	-	39	50	57	2,5	3,8	3,8	1	50
DG M63	0258 0017 010	-	53	63	75	2,5	3,8	3,8	1	50
DG M68	0258 0019 010	-	53	68	75	2,5	3,8	3,8	1,5	50
DG M75	0258 0018 010	-	65	75	87	2,5	3,8	3,8	1	50

• Thick membrane

type	article number		dimensions (mm)							pcs
	black 010		Ø A	Ø B	Ø C	E	F1	F2	M	
DG 16/E3	0258 0449 010		16	22,5	27,5	3	2,5	2,5	2	100
DG 16/E4	0258 0440 010		16	22,5	27,5	4	2,5	2,5	3	100
DG 21/E4	0258 0441 010		21	28	35	4	3	3	3	100
DG 29/E6	0258 0445 010		29	37	44	6	3,5	3,5	5	100
DG 36/E3	0258 0362 010		36	47	54	3	3,8	5	3	100

HELAVIA® membrane grommets DG in black polychloroprene rubber



HELAVIA®



• Cross-cut membrane

type	art. no.	dimensions (mm)							pcs
		Ø A	Ø B	Ø C	E	F	M	X	
DGC 11	0258 0401 010	11	18,5	23	2	2,5	1	10	100
DGC 13,5	0258 0402 010	13,5	20,5	25	2	2,5	1	10	100
DGC 16	0258 0403 010	16	22,5	27,5	2	2,5	1	14	100
DGC 21	0258 0404 010	21	28	35	2	3	1	17	100
DGC 29	0258 0405 010	29	37	44	2	3,5	1	25	50
DGC 36	0258 0406 010	36	47	54	2,5	3,8	1	32	50
DGC 48	0258 0407 010	48	60	68	2,5	3,8	1	42	50
DGC 53	0258 0408 010	53	64	75	2,5	3,8	1,5	25	50

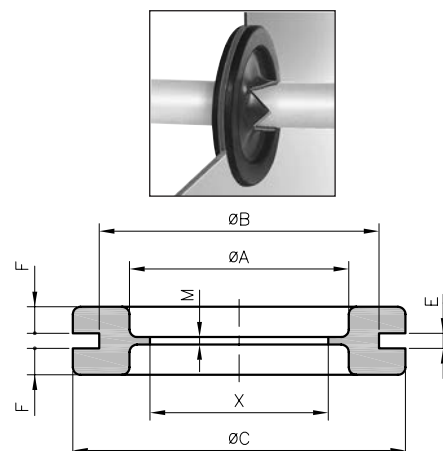

• Perforated membrane (semi-standard)

type	art. no.	dimensions (mm)									pcs
		Ø A	Ø B	Ø C	E	F1	F2	M	Ø P		
DG 9/4,5	0258 0415 010	9	15,5	20	2	2,5	2,5	1	4,5	100	
DG 11/3,5	0258 0419 010	11	18,5	23	2	2,5	2,5	1	3,5	100	
DG 11/4,5	0258 0416 010	11	18,5	23	2	2,5	2,5	1	4,5	100	
DG 13,5/4,5	0258 0417 010	13,5	20,5	25	2	2,5	2,5	1	4,5	100	
DG 13,5/8	0258 0418 010	13,5	20,5	25	2	2,5	2,5	1	8	100	
DG 16/5	0258 0431 010	16	22,5	27,5	2	2,5	2,5	1	5	100	
DG 16/10	0258 0420 010	16	22,5	27,5	2	2,5	2,5	1	10	100	
DG 16/15	0258 0427 010	16	22,5	27,5	2	2,5	2,5	1	15	100	
DG 16/15E3	0258 0423 010	16	22,5	27,5	3	2,5	2,5	2	15	100	
DG 21/3	0258 0438 010	21	28	35	2	3	3	1	3	100	
DG 21/5	0258 0439 010	21	28	35	2	3	3	1	5	100	
DG 21/6	0258 0436 010	21	28	35	2	3	3	1	6	100	
DG 21/10	0258 0432 010	21	28	35	2	3	3	1	10	100	
DG 21/18	0258 0421 010	21	28	35	2	3	3	1	18	100	
DG 21/20	0258 0422 010	21	28	35	2	3	3	1	20	100	
DG 29/10	0258 0433 010	29	37	44	2	3,5	3,5	1	10	50	
DG 29/14	0258 0434 010	29	37	44	2	3,5	3,5	1	14	50	
DG 29/18	0258 0429 010	29	37	44	2	3,5	3,5	1	18	50	
DG 36/10	0258 0447 010	36	47	54	2,5	3,8	3,8	1	10	50	
DG 36/14	0258 0430 010	36	47	54	2,5	3,8	3,8	1	14	50	
DG 36/19E3	0258 0451 010	36	47	54	3	3,8	5	3	19,2	50	
DG 36/32	0258 0435 010	36	47	54	2,5	3,8	3,8	1	32	50	
DG 48/14	0258 0446 010	48	60	68	2,5	3,8	3,8	1	14	50	
DG 48/16	0258 0443 010	48	60	68	2,5	3,8	3,8	1	16	50	
DG 48/22	0258 0444 010	48	60	68	2,5	3,8	3,8	1	22	50	
DG 53/52	0258 0448 010	53	64	75	2,5	3,8	3,8	1,5	52	50	
DG 69/16	0258 0426 010	69	79	90	2,5	3,8	3,8	1,5	16	50	
DG 69/36	0258 0437 010	69	79	90	2,5	3,8	3,8	1,5	36	50	
DG 69/55	0258 0442 010	69	79	90	2,5	3,8	3,8	1,5	55	50	

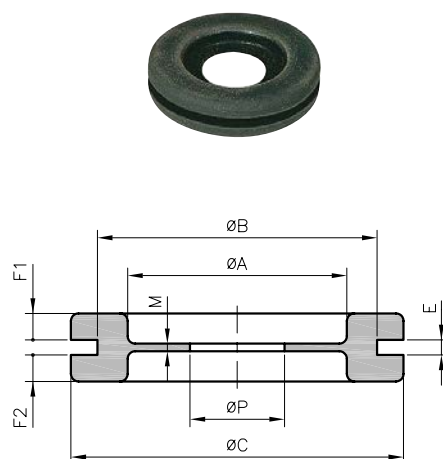

On request other cut-outs are possible.

HELAVIA® membrane grommets DG in black polychloroprene rubber



HELAVIA®



type	art. no.	dimensions (mm)								pcs
		Ø A	Ø B	Ø C	E	F	M	Ø P		

• Cut series with perforated membrane

DG 21/3F	0258 0424 010	21	28	35	2	3	1	3	100
DG 48/30F	0258 0428 010	48	60	68	2,5	3,8	1	30	50

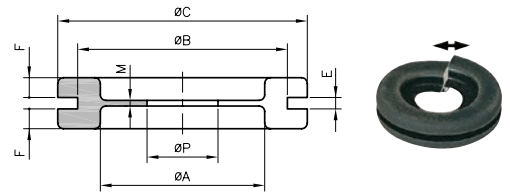

• Special perforated membrane

DG 21/6x2	0258 0450 010	21	28	35	2	3	1	6	100 (2 holes)
DG 36/16EXC	0258 0425 010	36	47	54	2,5	3,8	1	16	50 (off-centered)

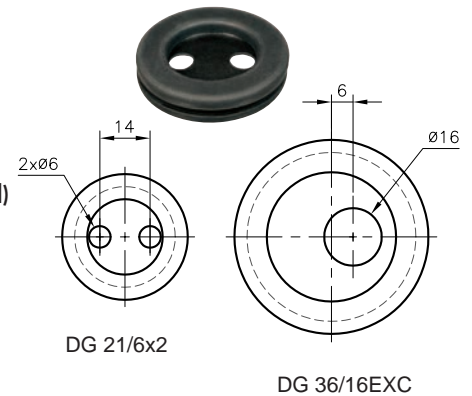

HELAVIA® sleeved grommets in polychloroprene rubber

HELAVIA®



15-2**

Material:	polychloroprene rubber
Colours:	black
Temperature range:	-30 to +90°C
Tensile strength at break:	7 MPa
Ultimate elongation:	> 400 %
Dielectric strength:	> 13 kV/mm
Applications:	protection of cables in the passage of sheet steel, and protection against twisting.



type	art. no.	dimensions (mm)		pcs
		ØA	ØB	
15-206	0259 0019 010	2	4,3	100
15-201	0259 0020 010	4	6,3	100
15-202	0259 0021 010	6	8,3	100
15-203	0259 0022 010	8	10,5	100
15-204	0259 0023 010	10,5	13,5	100
15-205	0259 0024 010	13	16	100

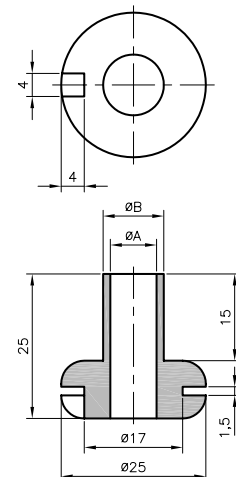

HELAVIA® universal flexible DV wire-clamps in polychloroprene rubber (Neoprene)



HELAVIA®



DV

Material: polychloroprene rubber
Colours: black
Temperature range: -30 to +90°C
Tensile strength at break: > 8 MPa
Ultimate elongation: > 600 %
Dielectric strength: > 13 kV/mm
Applications: for protection and strain relief, very effective when used with SES-QUICK cable ties, in the passages of boxes, of cupboards or crankcase, etc.



• DV wire-clamps in Bags, without ties

type	article number	dimensions (mm)					pcs	cable ties to be used	
		housing Ø	wire Ø	Ø A	B	C		type	article number
DV 4 / 9	0252 0511 010	16	4 - 9	24	18,6	3	100	145/34 SL-C	0186 0979 010
DV 7 / 12	0252 0521 010	19	7 - 12	28	18,7	3	100	145/34 SL-C	0186 0979 010
DV 12 / 18	0252 0531 010	25	12 - 18	34	22	3	100	185/46 SL-C	0186 0983 010
DV 18 / 25	0252 0541 010	32	18 - 25	43	24	3	50	185/46 SL-C	0186 0983 010
DV 25 / 32	0252 0551 010	38	25 - 32	51	24,5	4	50	185/46 SL-C	0186 0983 010

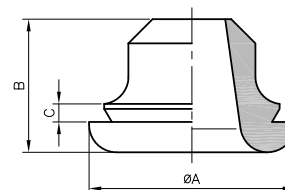

• DV wire-clamps in Bags, with ties

type	article number	dimensions (mm)					pcs	delivered with ties
		housing Ø	wire Ø	Ø A	B	C		
DV 4 / 9	0252 0510 010	16	4 - 9	24	18,6	3	10	145/34 SL-C
DV 7 / 12	0252 0520 010	19	7 - 12	28	18,7	3	10	145/34 SL-C
DV 12 / 18	0252 0530 010	25	12 - 18	34	22	3	10	185/46 SL-C
DV 18 / 25	0252 0540 010	32	18 - 25	43	24	3	5	185/46 SL-C
DV 25 / 32	0252 0550 010	38	25 - 32	51	24,5	4	5	185/46 SL-C

Assembly instruction

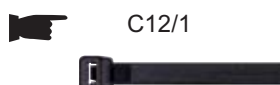
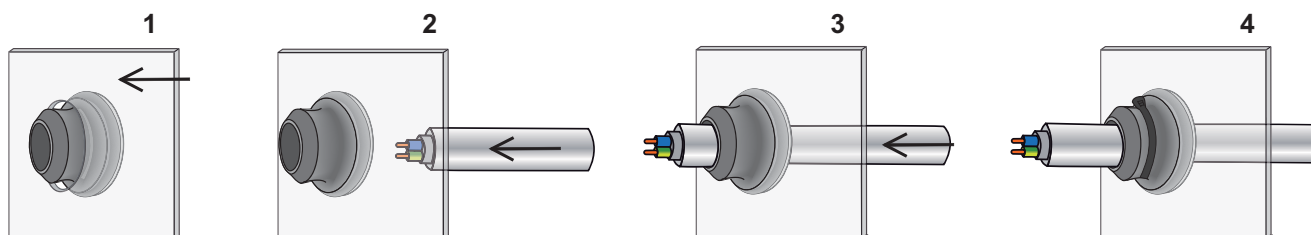

HELAVIA® grommets DX, in polychloroprene rubber



HELAVIA®



DX

- Material:** polychloroprene rubber
- Colours:** black
- Temperature range:** -30 to +90°C
- Tensile strength at break:** 10 MPa
- Ultimate elongation:** > 600 %
- Dielectric strength:** > 13 kV/mm
- Protection factor:** IP 67

Applications: for all exits of panels, enclosures and housings of all types, etc. Owing to the closed cover, it is possible to use it as a temporary seal for a later wiring. In order to introduce the cable, the cover can be perforated for example with the help of a screwdriver.



type	article number	hole Ø	Ø de câbles	dimensions (mm)			C	pcs
				metal thickness	Ø A	Ø B		
DX 10 - 15	0252 0603 010	25,5	10 - 15	1 - 4	31	29	26	100
DX 14 - 20	0252 0604 010	32,5	14 - 20	1 - 4	38	36	28	50

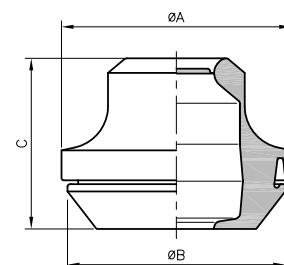

Assembly instruction

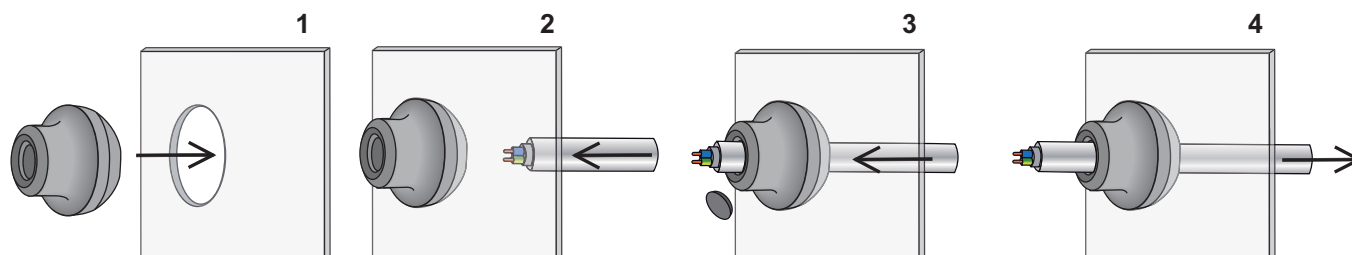

DX grommets, sealing in EPDM rubber



DX



DX-M / DX-PG

Material: EPDM
Colours: black
 light grey (RAL 7035)
Temperature of use: -40 to +110°C
Specification: IP 67 according to EN 60 529

Applications: grommets, sealing for all exits of panels, enclosures and housings of all types, etc.



• Metric grommets

type	article number		cable Ø	hole Ø	dimensions (mm)				pcs
	black 010	grey 025			metal thickness	Ø A	B	C	
DX-M 12	0252 0610 010	0252 0610 025	4 - 7	12,5	0,5 - 2	20	12,8	5,6	50
DX-M 16	0252 0611 010	0252 0611 025	5 - 9	16,5	1 - 4	21	17,7	11	50
DX-M 20	0252 0612 010	0252 0612 025	8 - 12	20,5	1 - 4	25,5	20	13,4	50
DX-M 25	0252 0613 010	0252 0613 025	11 - 16	25,5	1 - 4	30,5	21,3	15,3	50
DX-M 32	0252 0614 010	0252 0614 025	15 - 20	32,5	1 - 4	38,5	24,6	18,6	25
DX-M 40	0252 0615 010	0252 0615 025	19 - 28	40,5	1 - 4	48,5	29,5	21,7	25
DX-M 50	0252 0616 010	0252 0616 025	27 - 35	50,5	1 - 4	60,5	34,8	25	10

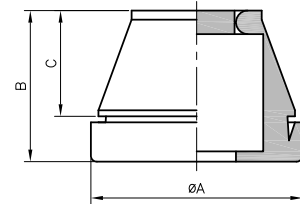

• PG grommets

type	article number		cable Ø	hole Ø	dimensions (mm)				pcs
	black 010	grey 025			metal thickness	Ø A	B	C	
DX-PG 7	0252 0620 010	0252 0620 025	3 - 5	13	0,5 - 2	20	12,6	5,4	50
DX-PG 9	0252 0621 010	0252 0621 025	5 - 7	16	1 - 4	21	17,8	10,3	50
DX-PG 11	0252 0622 010	0252 0622 025	7 - 10	19	1 - 4	24	19,8	12,7	50
DX-PG 16	0252 0623 010	0252 0623 025	10 - 14	23	1 - 4	28	21,6	14,7	50
DX-PG 21	0252 0624 010	0252 0624 025	14 - 20	29	1 - 4	35	24,6	17,6	25
DX-PG 29	0252 0625 010	0252 0625 025	20 - 26	38	1 - 4	46	28,5	20	25
DX-PG 36	0252 0626 010	0252 0626 025	26 - 35	48	1 - 4	58	34,9	23,9	10

Assembly instruction

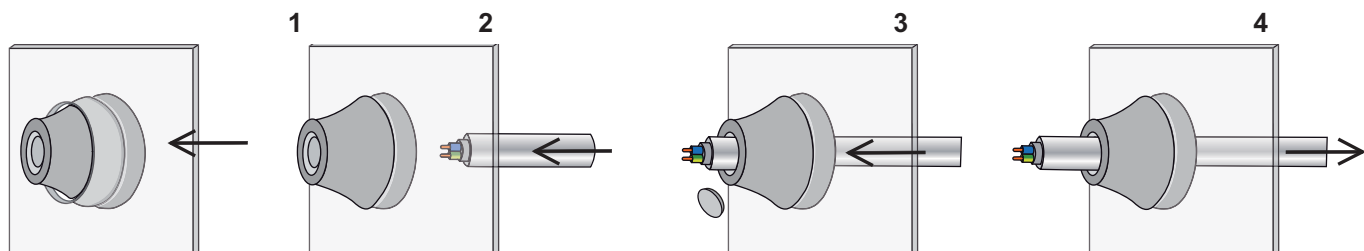

HELAVIA® semi-special grommets
in black polychloroprene rubber
Technical properties page D100



HELAVIA®



type	code		type	code		type	code	
15-010	0257 0020 010	100	15-565	0257 0019 010	100	15-679	0257 0061 010	100
15-033	0257 0001 010	100	15-580 SNCF*	0257 0168 010	100	15-687	0257 0062 010	100
15-076	0257 0003 010	100	15-595	0257 0034 010	100	15-734	0257 0004 010	15
15-093	0257 0005 010	100	15-610 SNCF*	0257 0035 010	1	15-742	0257 0063 010	100
15-187	0257 0008 010	100	15-611	0257 0036 010	100	15-746	0257 0064 010	100
15-309	0257 0009 010	25	15-612	0257 0037 010	100	15-803 SNCF*	0257 0066 010	1
15-377	0257 0012 010	100	15-613	0257 0038 010	100	15-808	0257 0067 010	50
15-394	0257 0033 010	100	15-614	0257 0039 010	100	15-819 SNCF*	0257 0071 010	1
15-519	0257 0017 010	100	15-644**	0257 0040 010	25	15-820 SNCF*	0257 0072 010	1
15-539 SNCF*	0257 0118 010	100	15-645	0257 0041 010	100			

* Nitrile rubber
** EPDM rubber

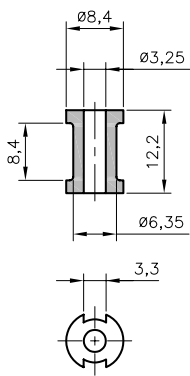

15-611
0257 0036 010

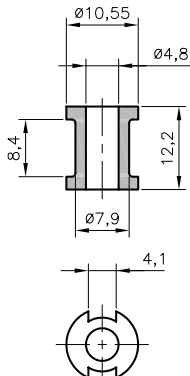

15-612
0257 0037 010

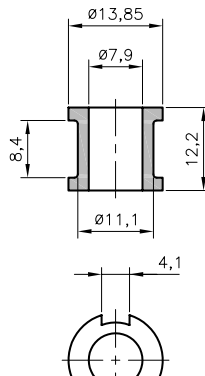

15-613
0257 0038 010

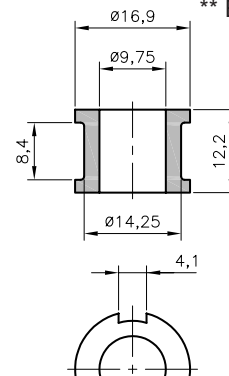

15-614
0257 0039 010

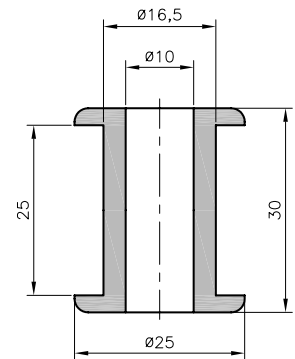

15-645
0257 0041 010

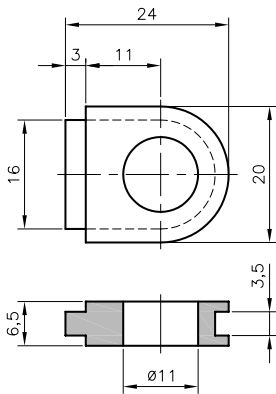

15-746
0257 0064 010

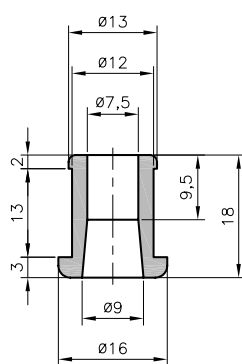

15-565
0257 0019 010

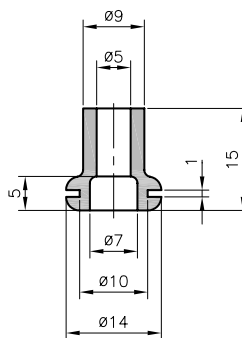

15-187
0257 0008 010

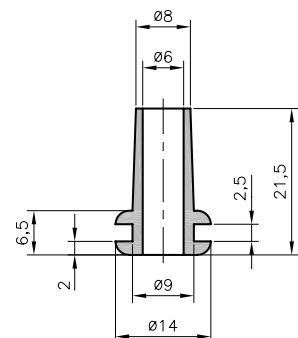

15-679
0257 0061 010

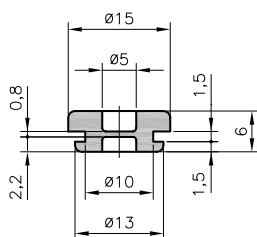

15-377
0257 0012 010

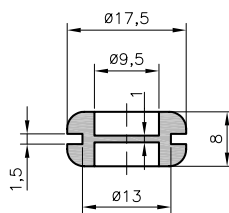

15-076
0257 0003 010

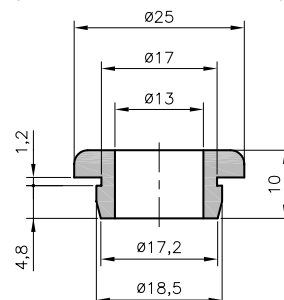

15-687
0257 0062 010

HELAVIA® semi-special grommets
in black polychloroprene rubber



HELAVIA®

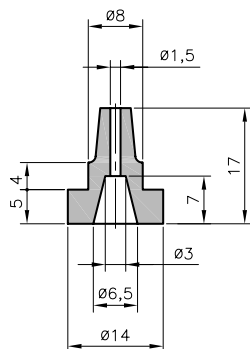

15-394
0257 0033 010

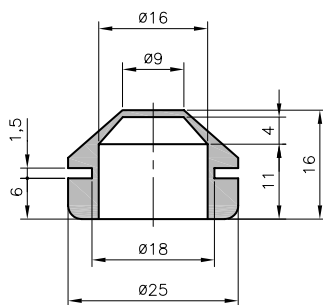

15-093
0257 0005 010

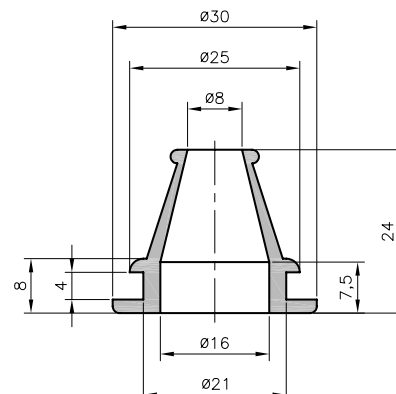

15-033
0257 0001 010

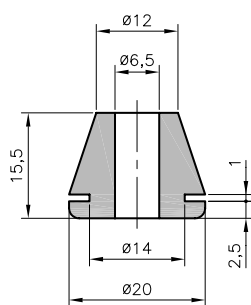

15-519
0257 0017 010

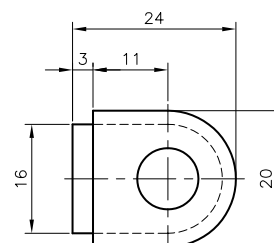
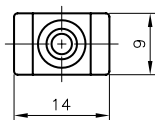

15-010
0257 0020 010

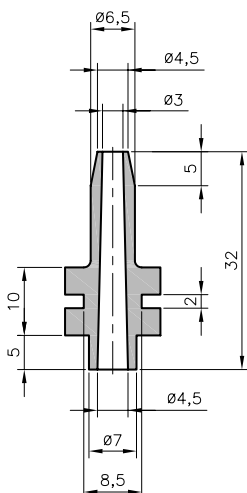

15-595
0257 0034 010

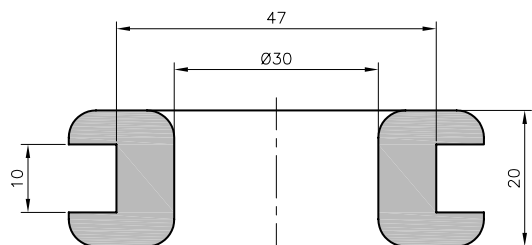
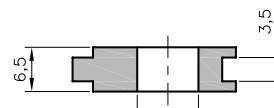

15-644**
0257 0040 010

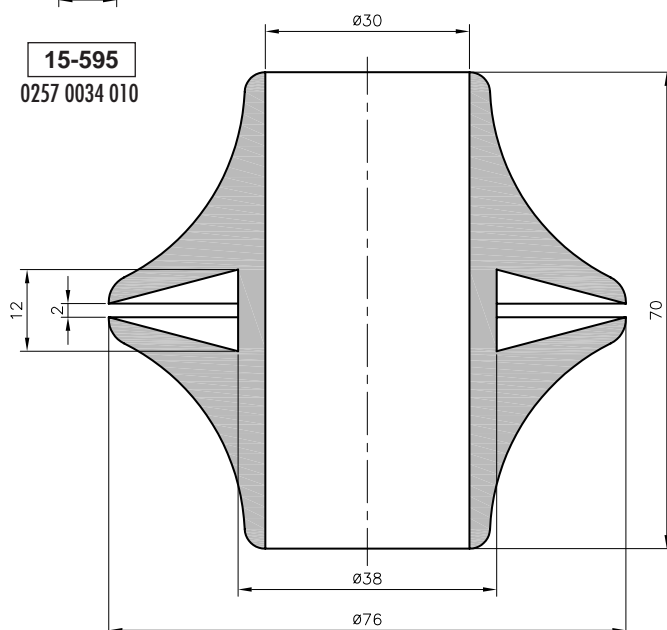
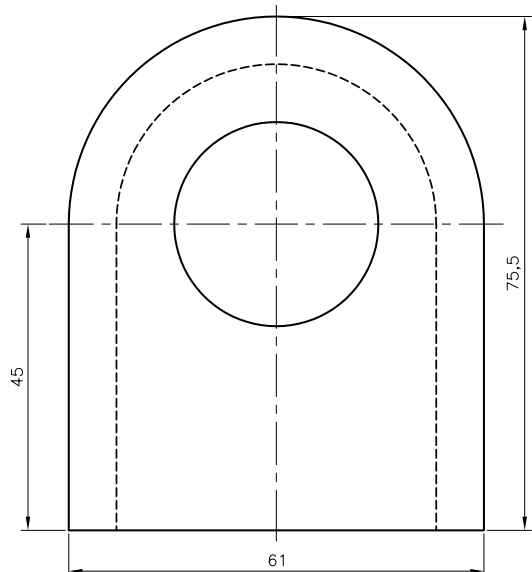

15-309
0257 0009 010

** in EPDM rubber



HELAVIA® semi-special grommets
in black polychloroprene rubber



HELAVIA®

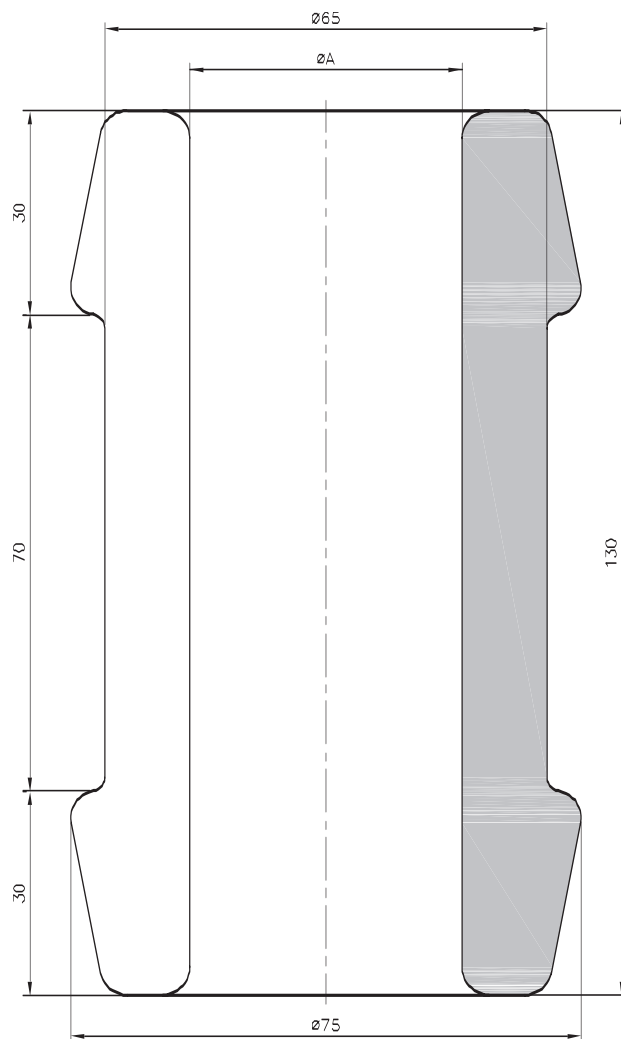

type	$\varnothing A$ mm	B mm
15-610	49	1,5
15-803	42	3
15-819	40	3
15-820	49	3

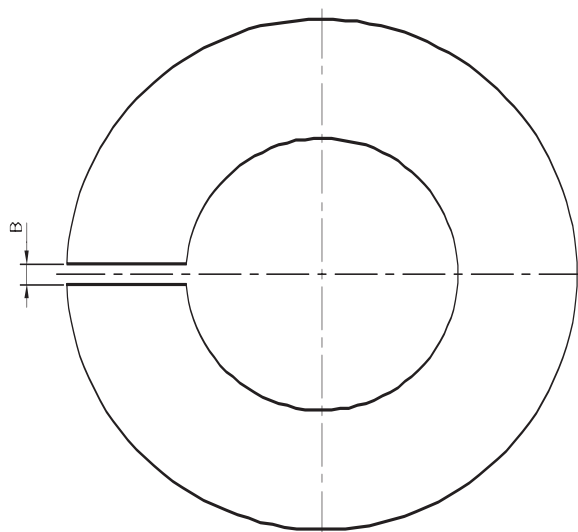

15-610*
0257 0035 010

15-803*
0257 0066 010

New
15-819*
0257 0071 010

New
15-820*
0257 0072 010

* in Nitrile rubber



HELAVIA® semi-special grommets
in black polychloroprene rubber



HELAVIA®

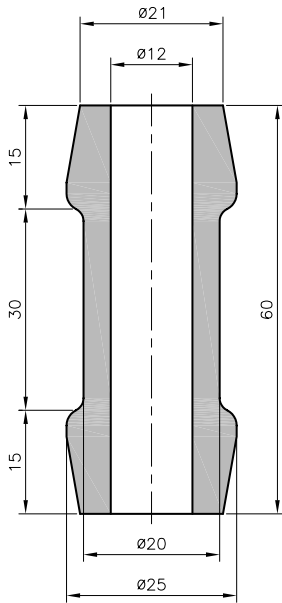

15-539*
0257 0118 010

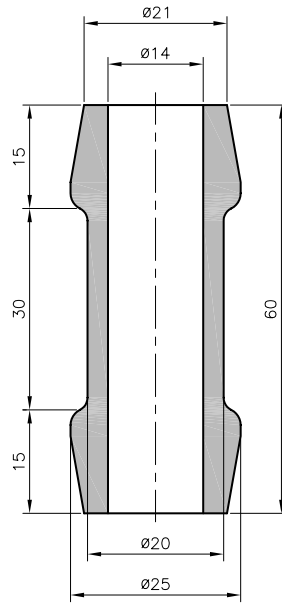

15-580*
0257 0168 010

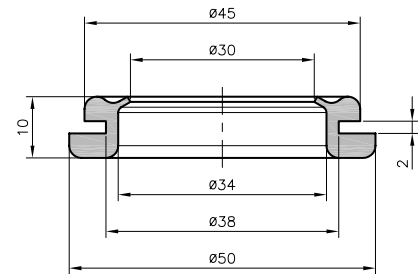

15-808
0257 0067 010

New

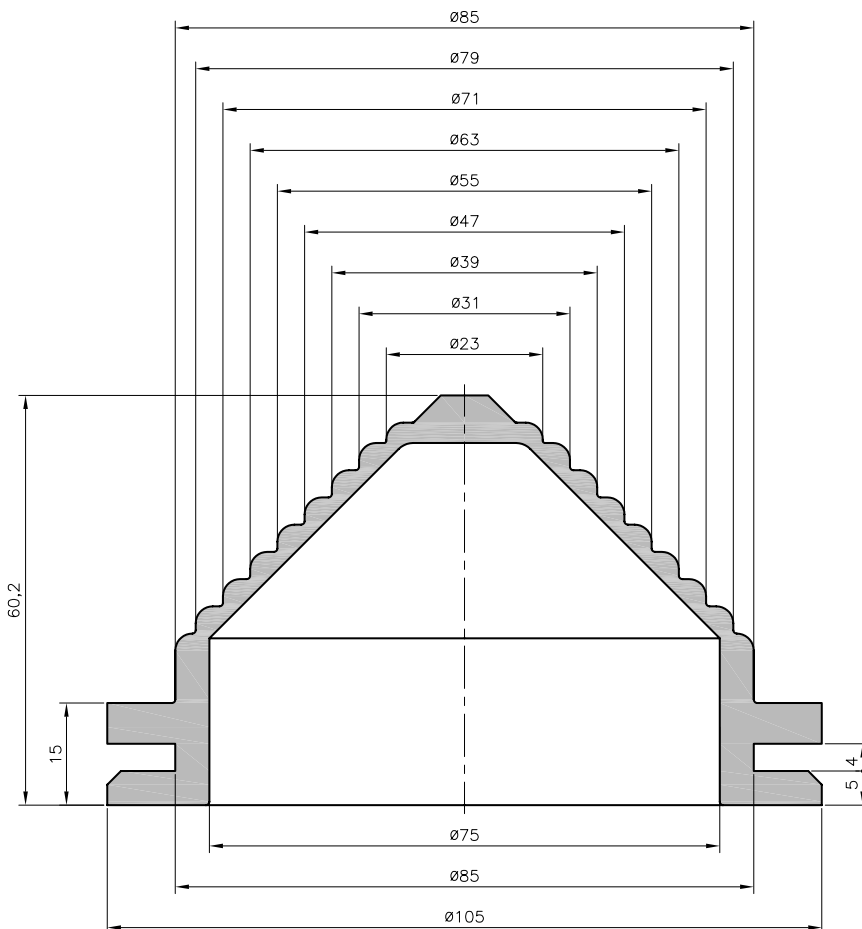

15-734
0257 0004 010

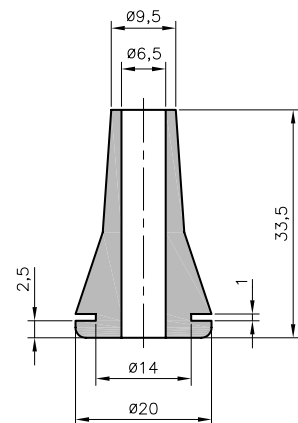

15-742
0257 0063 010

* in Nitrile rubber





type	artide number		type	artide number		type	artide number	
15-009	0253 0001 010	100	15-391	0253 0063 010	100	15-649	0253 0075 010	100
15-043	0253 0004 010	100	15-401	0256 0001 010	100	15-651	0253 0076 010	100
15-045	0253 0005 010	100	15-402	0256 0002 010	100	15-672	0253 0092 010	50
15-049	0253 0008 010	50	15-403	0256 0003 010	100	15-680	0253 0095 010	100
15-083	0253 0013 010	25	15-405	0256 0005 010	100	15-691**	0253 0110 010	100
15-130	0253 0014 010	50	15-410	0253 0051 010	100	15-692**	0253 0111 010	50
15-131	0253 0015 010	50	15-411	0253 0052 010	50	15-693**	0253 0112 010	50
15-147	0253 0016 010	50	15-412	0253 0053 010	50	15-721	0253 0003 010	100
15-159	0253 0017 010	100	15-538	0253 0064 010	100	15-737	0253 0080 010	50
15-164	0253 0018 010	50	15-561	0253 0065 010	100	15-747	0253 0083 010	50
15-169	0253 0019 010	100	15-579	0253 0066 010	50	15-748	0253 0084 010	50
15-170	0253 0020 010	100	15-592	0253 0070 010	50	15-751	0253 0091 010	50
15-171	0253 0021 010	100	15-596*	0253 0071 010	100	15-756	0253 0085 010	50
15-172	0253 0022 010	100	15-602**	0253 0072 010	50	15-760	0253 0113 010	100
15-190	0256 0010 010	100	15-608	0253 0073 010	100	15-781	0253 0087 010	50
15-306	0253 0057 010	100	15-625	0252 0319 010	100	15-806	0253 0114 010	100
15-318	0253 0058 010	100	15-633	0253 0077 010	50	15-821	0253 0115 010	100
15-320	0253 0059 010	25	15-642	0253 0078 010	100	15-822	0253 0117 010	100
15-329**	0253 0060 010	25	15-643	0253 0079 010	50			
15-354	0253 0061 010	100						
15-380	0253 0062 010	100						
15-383	0253 0056 010	100						

Clamps for 15-412

16-900 0684 0054 000 100

* nitrile rubber **EPDM rubber

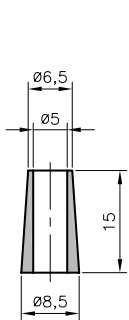

15-009
0253 0001 010

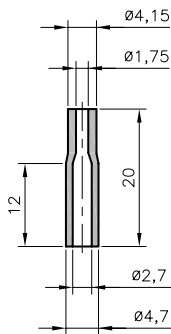

15-190
0256 0010 010

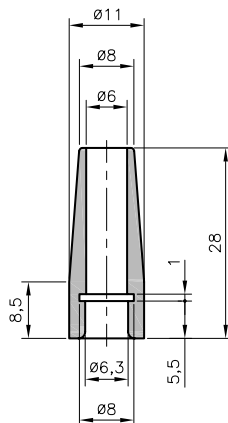

15-318
0253 0058 010

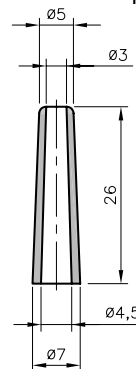

15-401
0256 0001 010

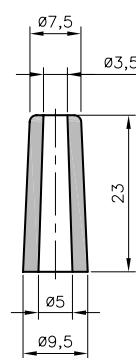

15-402
0256 0002 010

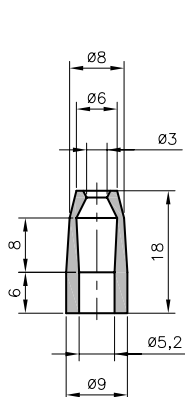

15-403
0256 0003 010

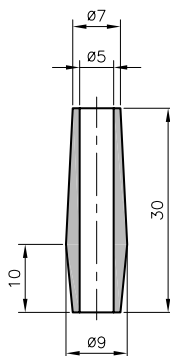

15-405
0256 0005 010

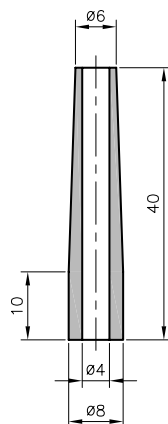

15-680
0253 0095 010

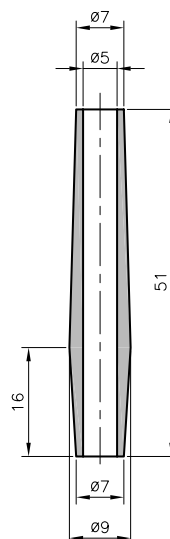

15-043
0253 0004 010

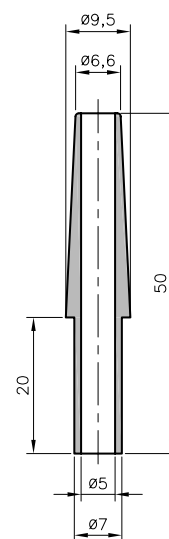

15-380
0253 0062 010

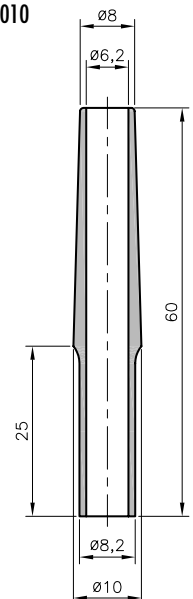

15-391
0253 0063 010

HELAVIA® bushes and strain relief
in black polychloroprene rubber



HELAVIA®

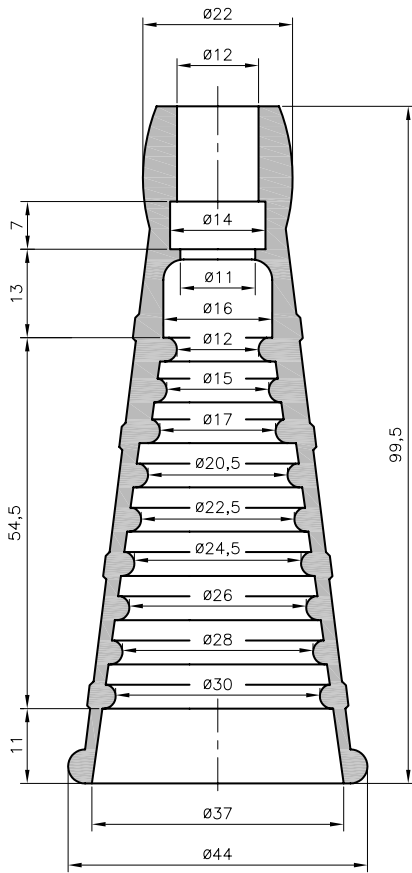

15-329
0253 0060 010

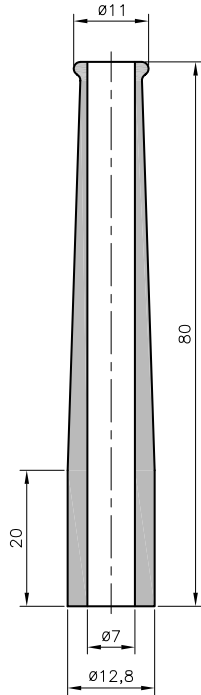

15-164
0253 0018 010

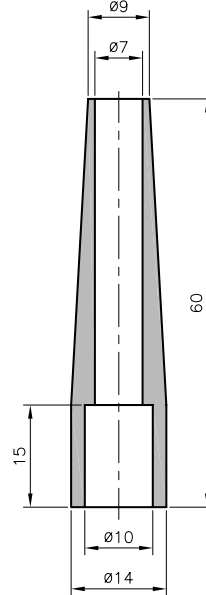

15-045
0253 0005 010

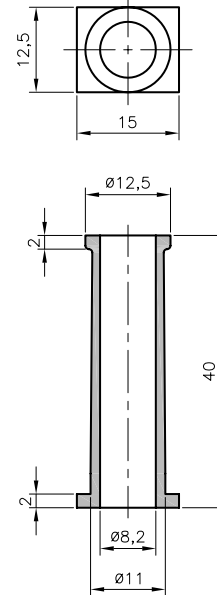

15-642
0253 0078 010

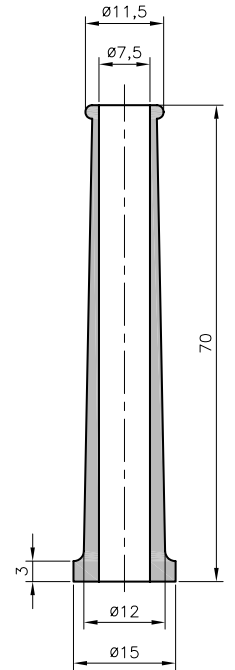

15-411
0253 0052 010

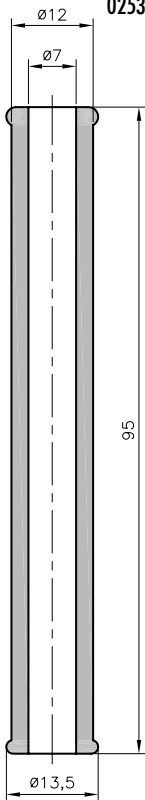

15-169
0253 0019 010

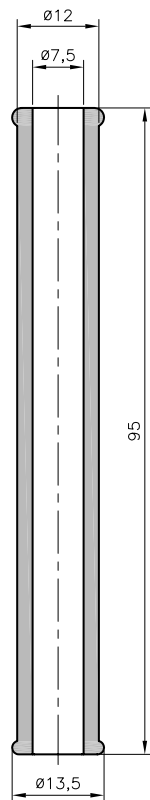

15-170
0253 0020 010

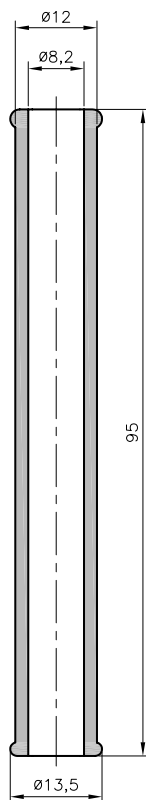

15-171
0253 0021 010

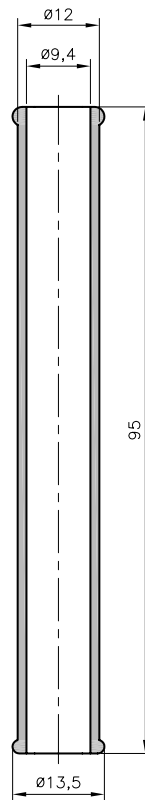

15-172
0253 0022 010

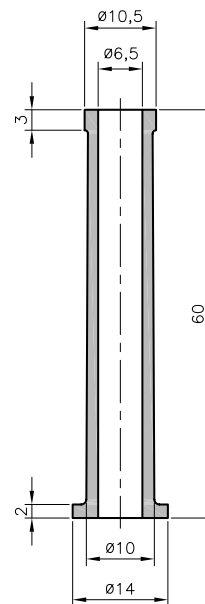

15-538
0253 0064 010

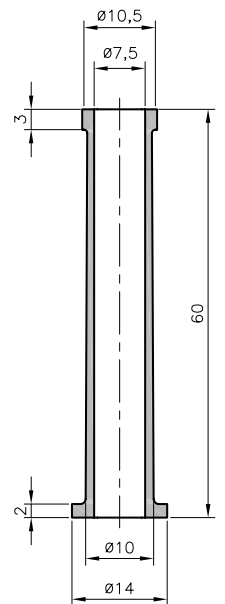

15-579
0253 0066 010



HELAVIA® bushes and strain relief
in black polychloroprene rubber



HELAVIA®

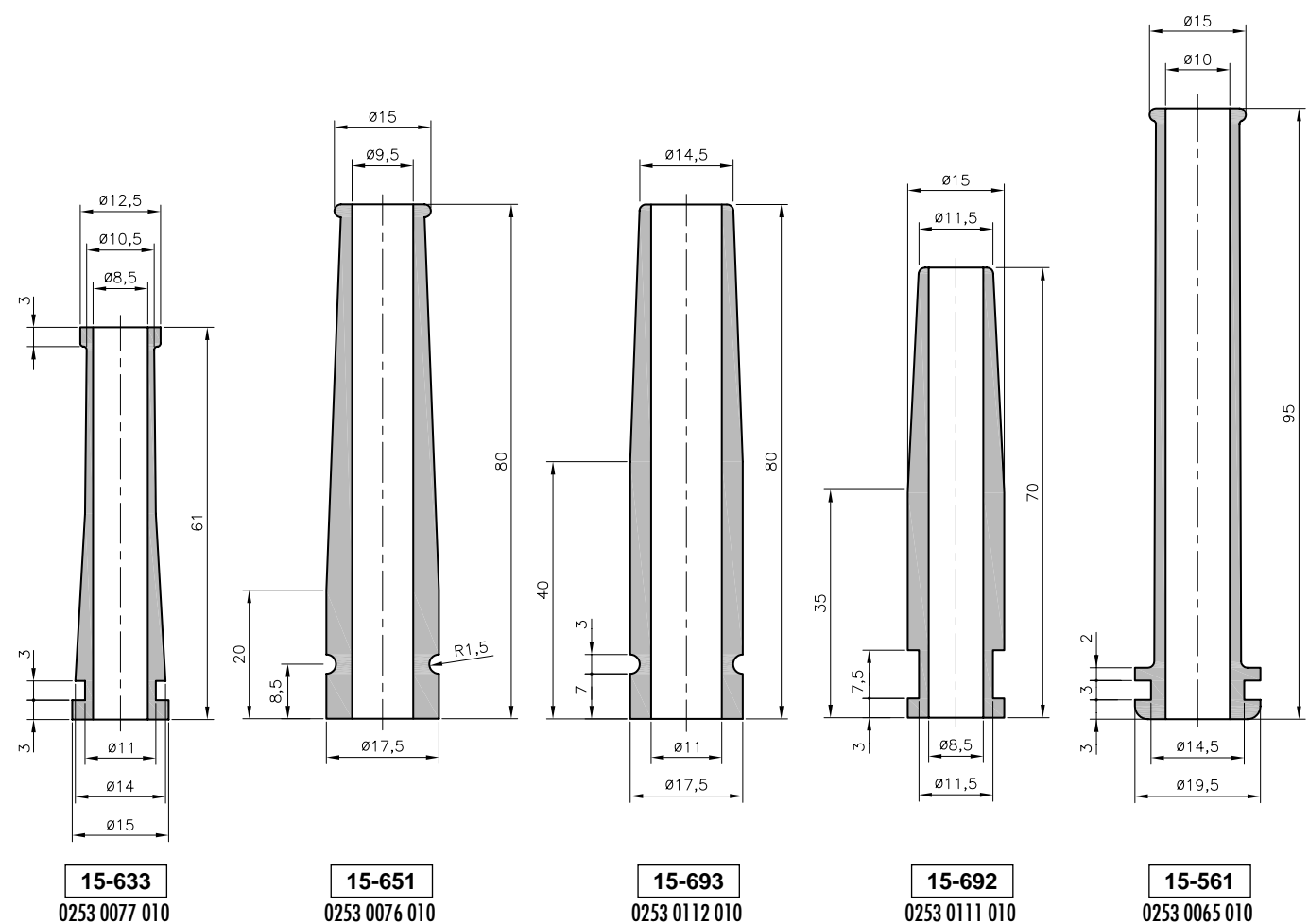
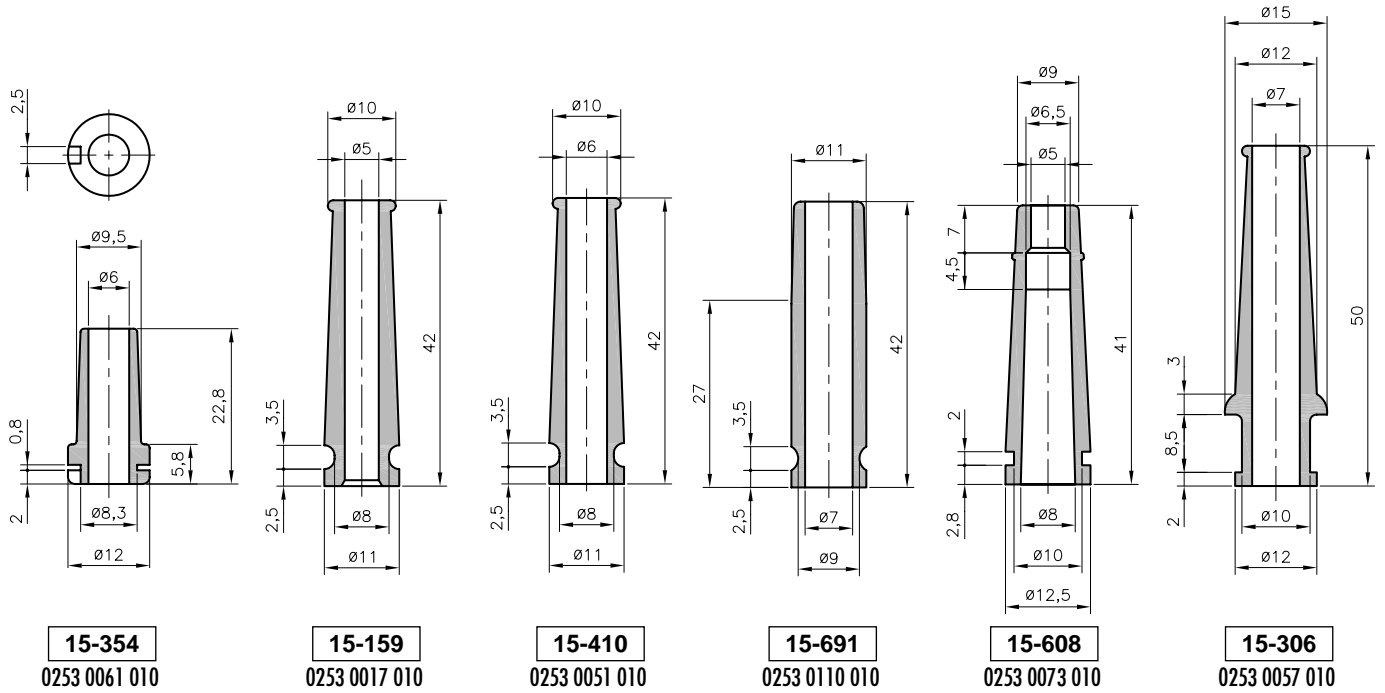

HELAVIA® bushes and strain relief
in black polychloroprene rubber



HELAVIA®

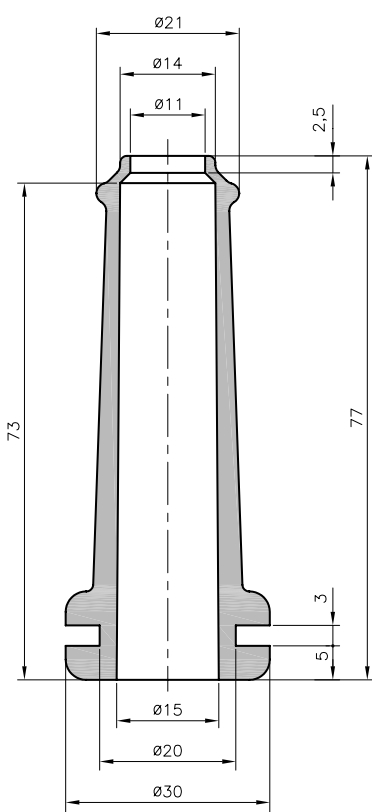

15-049
0253 0008 010

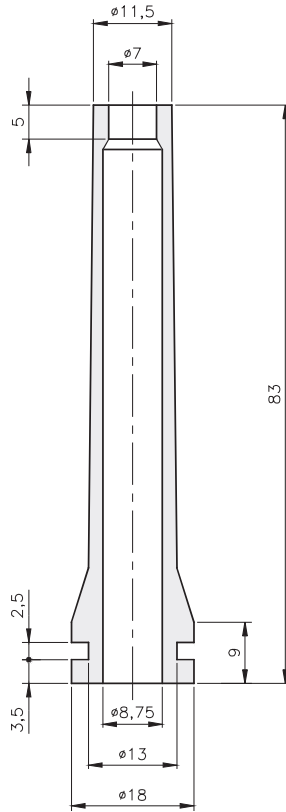

15-131
0253 0015 010

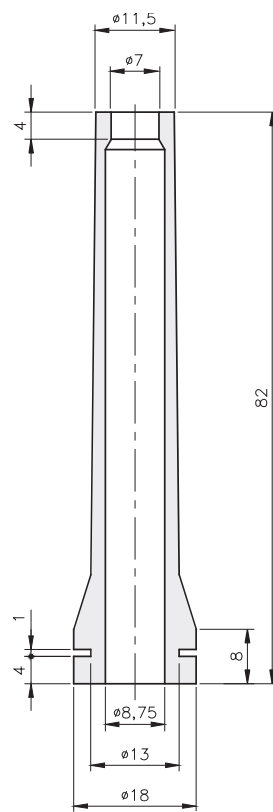

15-672
0253 0092 010

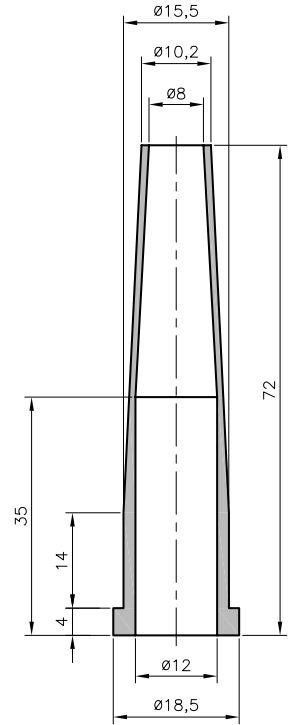

15-147
0253 0016 010

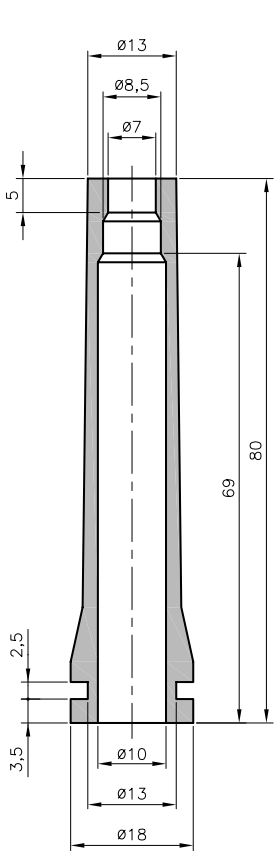

15-643
0253 0079 010

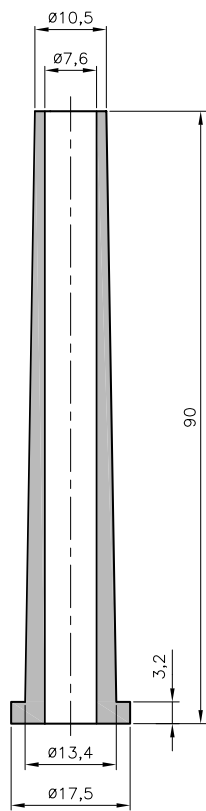

15-602
0253 0072 010

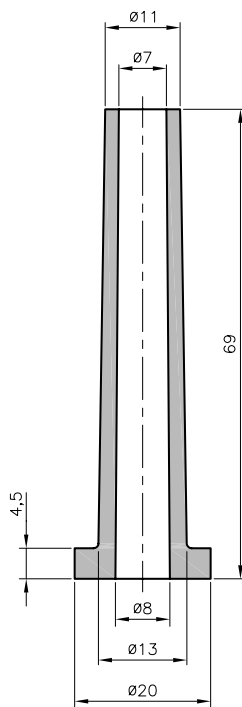

15-592
0253 0070 010

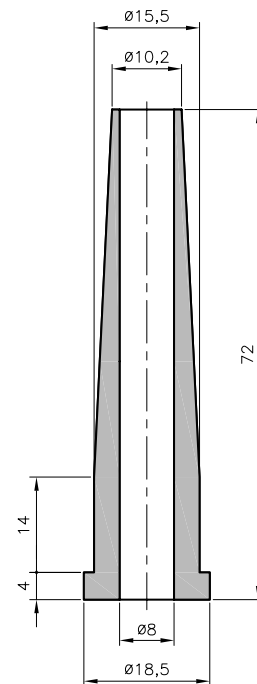

15-130
0253 0014 010

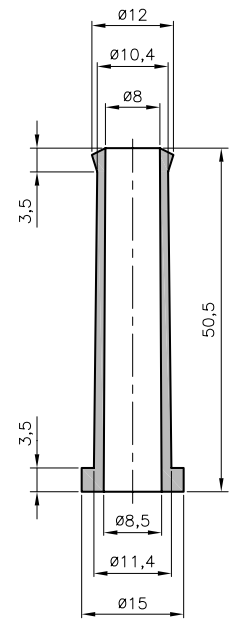

15-383
0253 0056 010



HELAVIA® bushes and strain relief
in black polychloroprene rubber



HELAVIA®

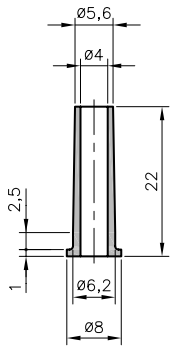

15-649
0253 0075 010

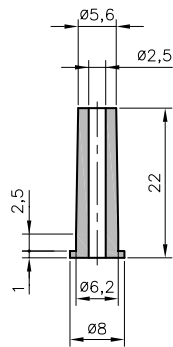

15-760
0253 0113 010

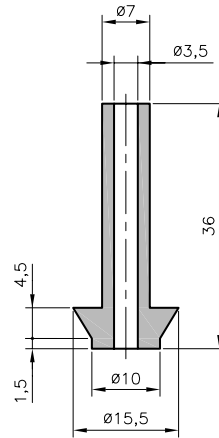

15-596
0253 0071 010

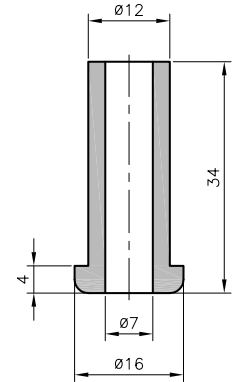

15-625
0252 0319 010

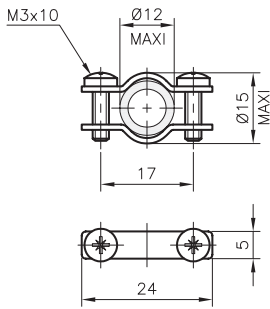

16-900
0684 0054 000

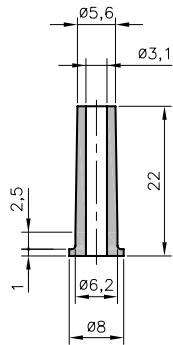

15-721
0253 0003 010

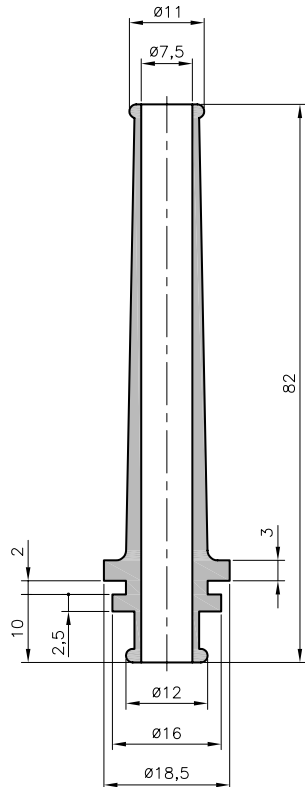

15-412
0253 0053 010

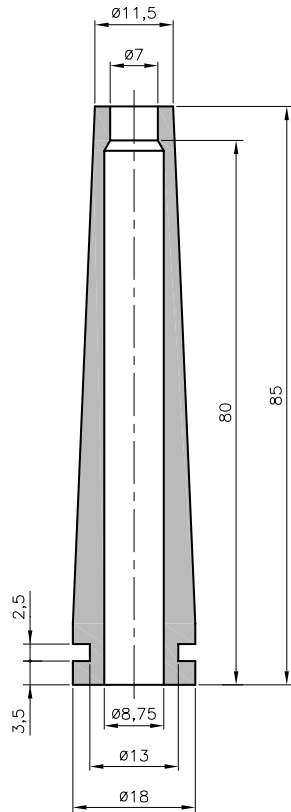

15-751
0253 0091 010

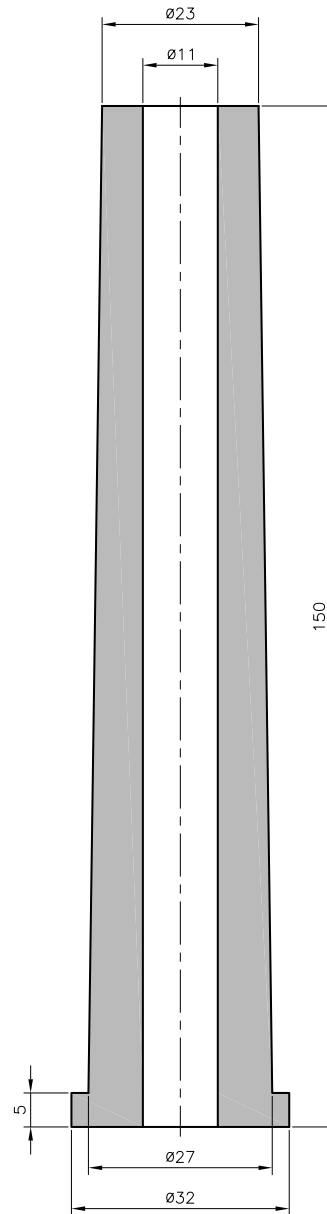

15-320
0253 0059 010

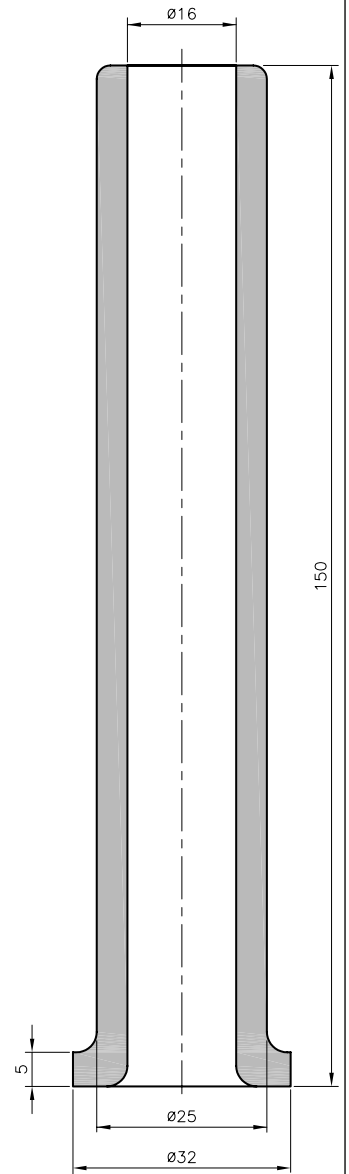

15-083
0253 0013 010



HELAVIA® bushes and strain relief
in black polychloroprene rubber



HELAVIA®



New

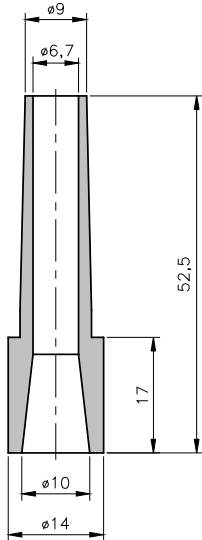

15-822
0253 0117 010

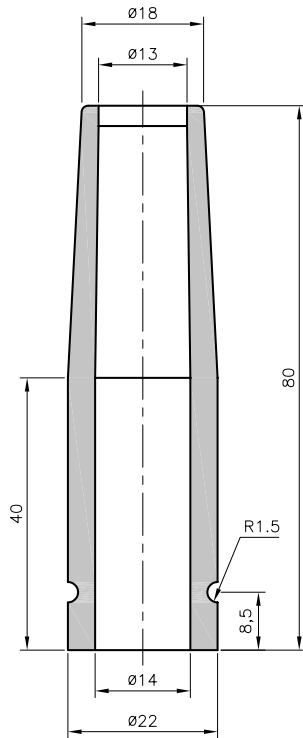

15-747
0253 0083 010

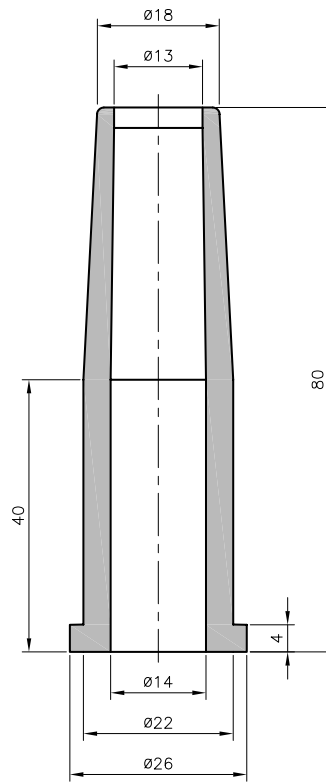

15-748
0253 0084 010

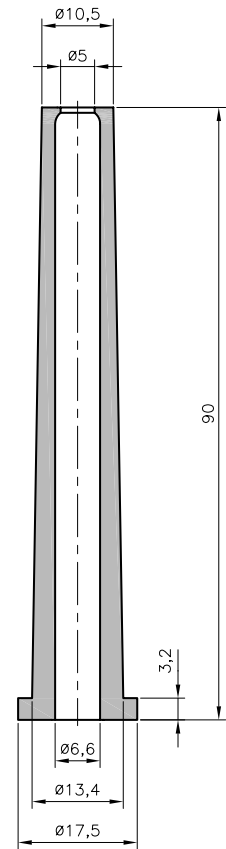

15-756
0253 0085 010

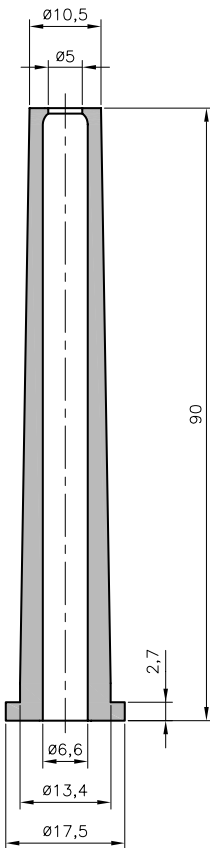

15-781
0253 0087 010

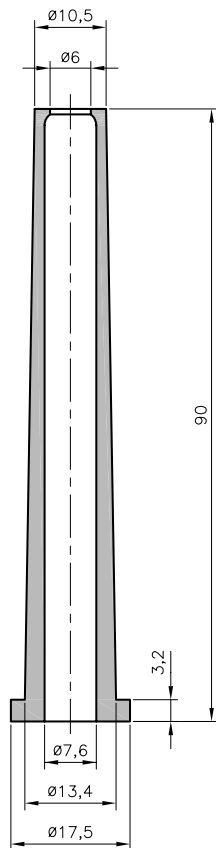

15-737
0253 0080 010

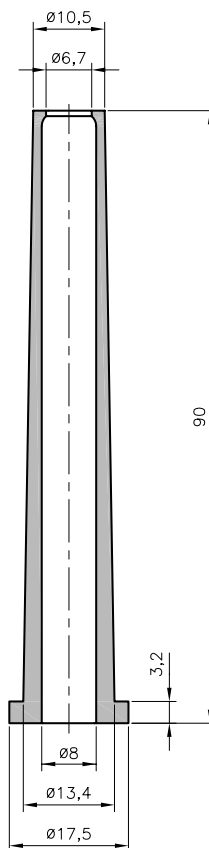

15-806
0253 0114 010

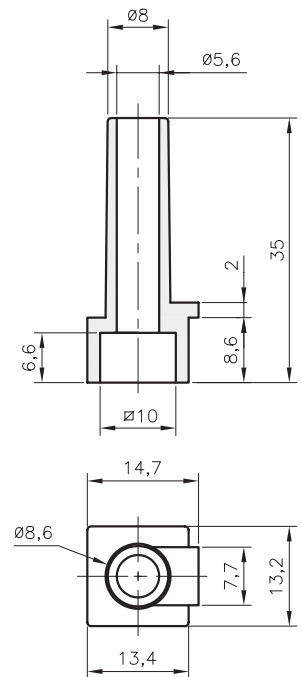

15-821
0253 0115 010





HELAVIA® moulded caps
in black polychloroprene rubber
Technical properties page D100



HELAVIA®



type	article number		type	article number		type	article number	
15 - 005	0254 0006 010	50	15 - 087	0254 0060 010	50	15 - 378**	0254 0082 010	100
15 - 019	0254 0052 010	100	15 - 152	0254 0071 010	100	15 - 634	0254 0085 010	25
15 - 024	0254 0053 010	25	15 - 160	0254 0072 010	100	15 - 652	0254 0089 010	100
15 - 028	0254 0078 010	25	15 - 163	0254 0073 010	50	15 - 683	0254 0092 010	25
15 - 029	0254 0055 010	50	15 - 166	0254 0074 010	50	15 - 684	0254 0093 010	25
15 - 074	0254 0064 010	100	15 - 186*	0254 0081 010	25	15 - 696	0254 0095 010	50
15 - 086	0254 0059 010	25	15 - 321	0254 0075 010	100	15 - 749	0254 0097 010	25

* Nitrile rubber

** EPDM rubber

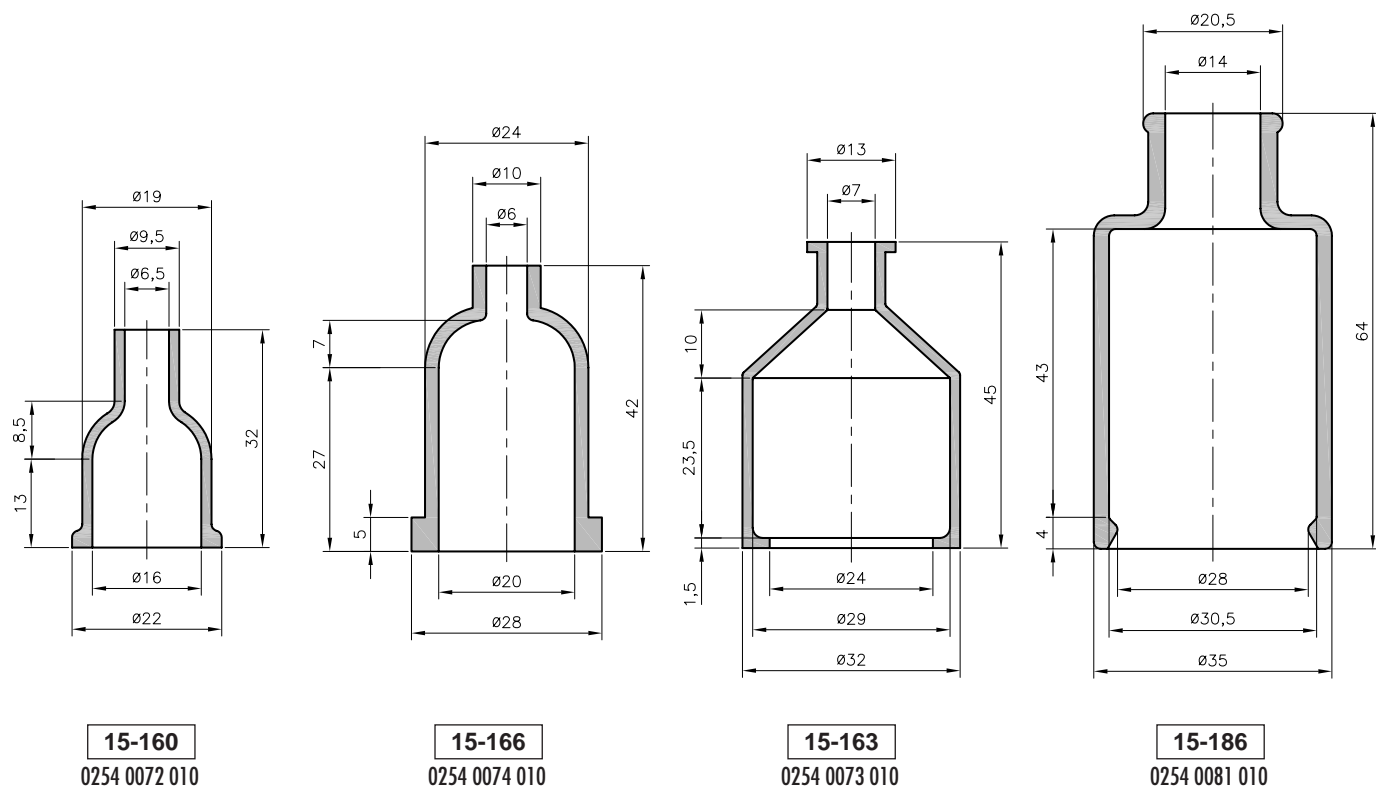
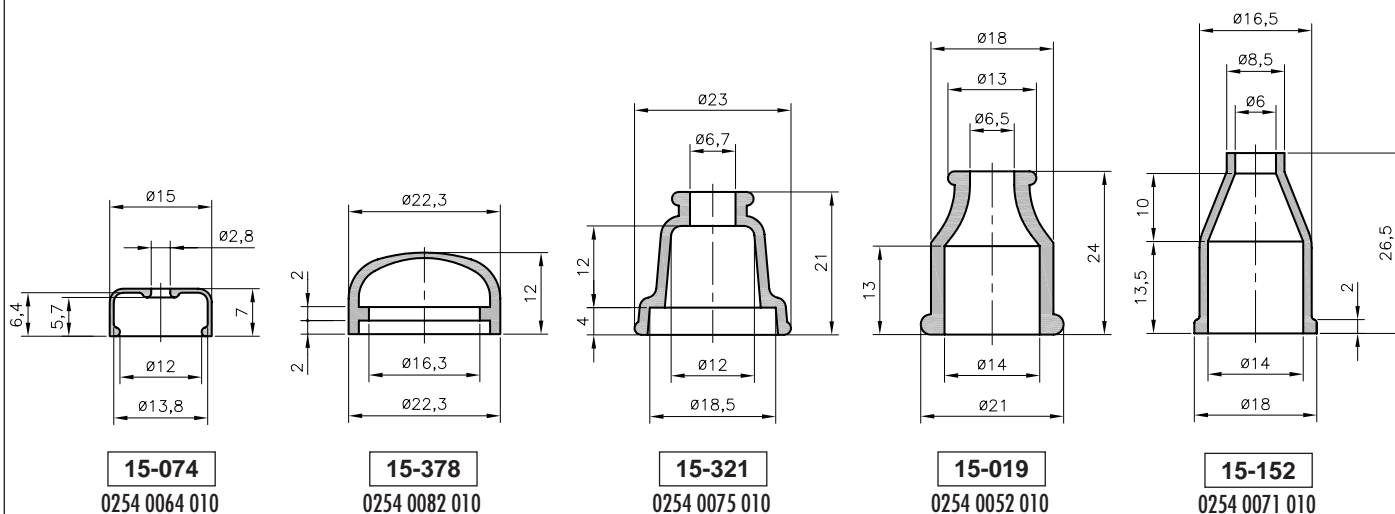

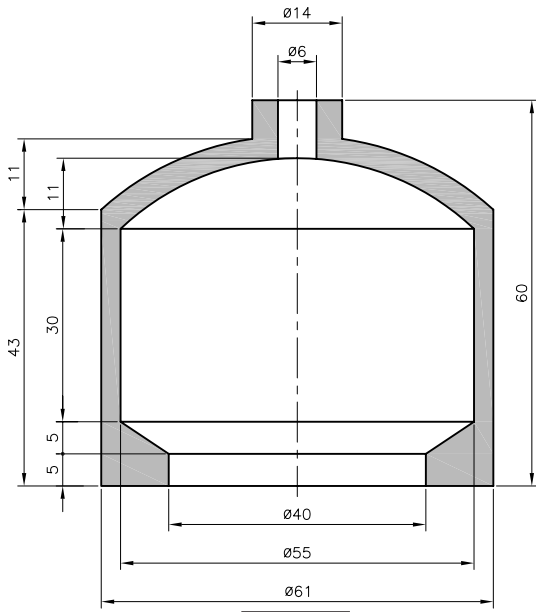

15-028
0254 0078 010

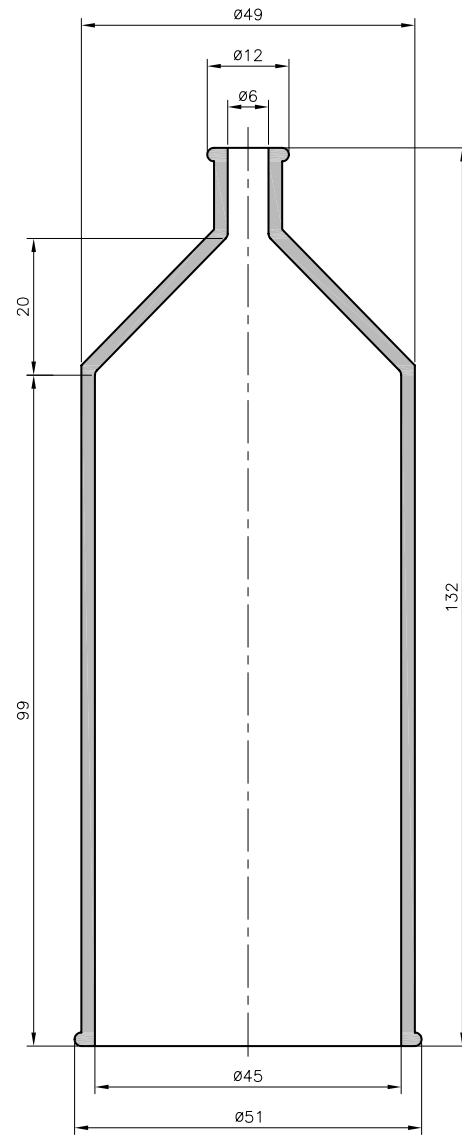

15-634
0254 0085 010

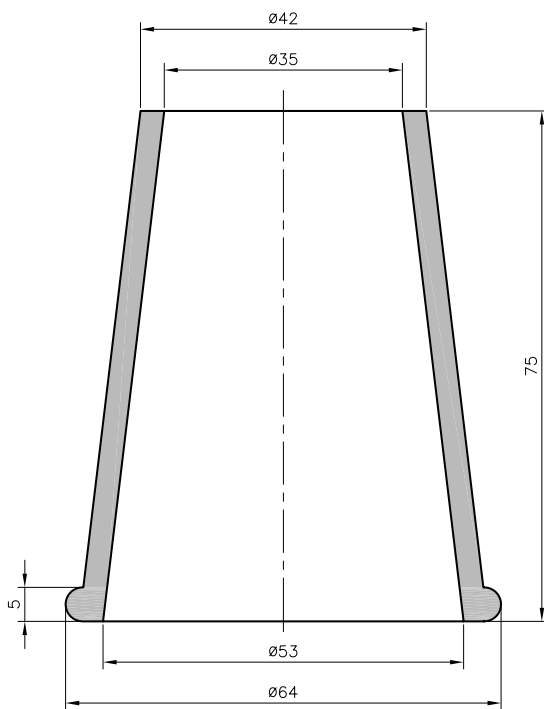

15-024
0254 0053 010

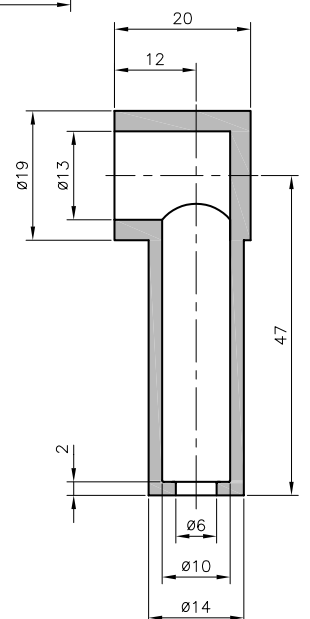

15-005
0254 0006 010

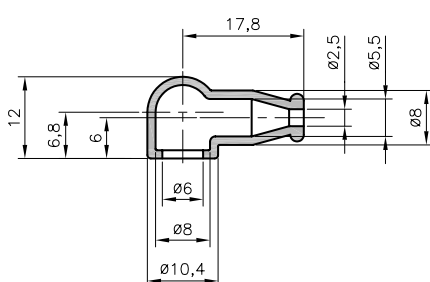

15-652
0254 0089 010

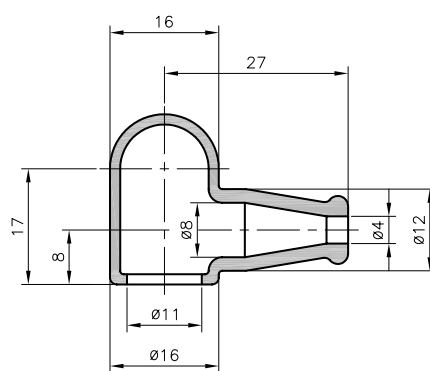

15-029
0254 0055 010

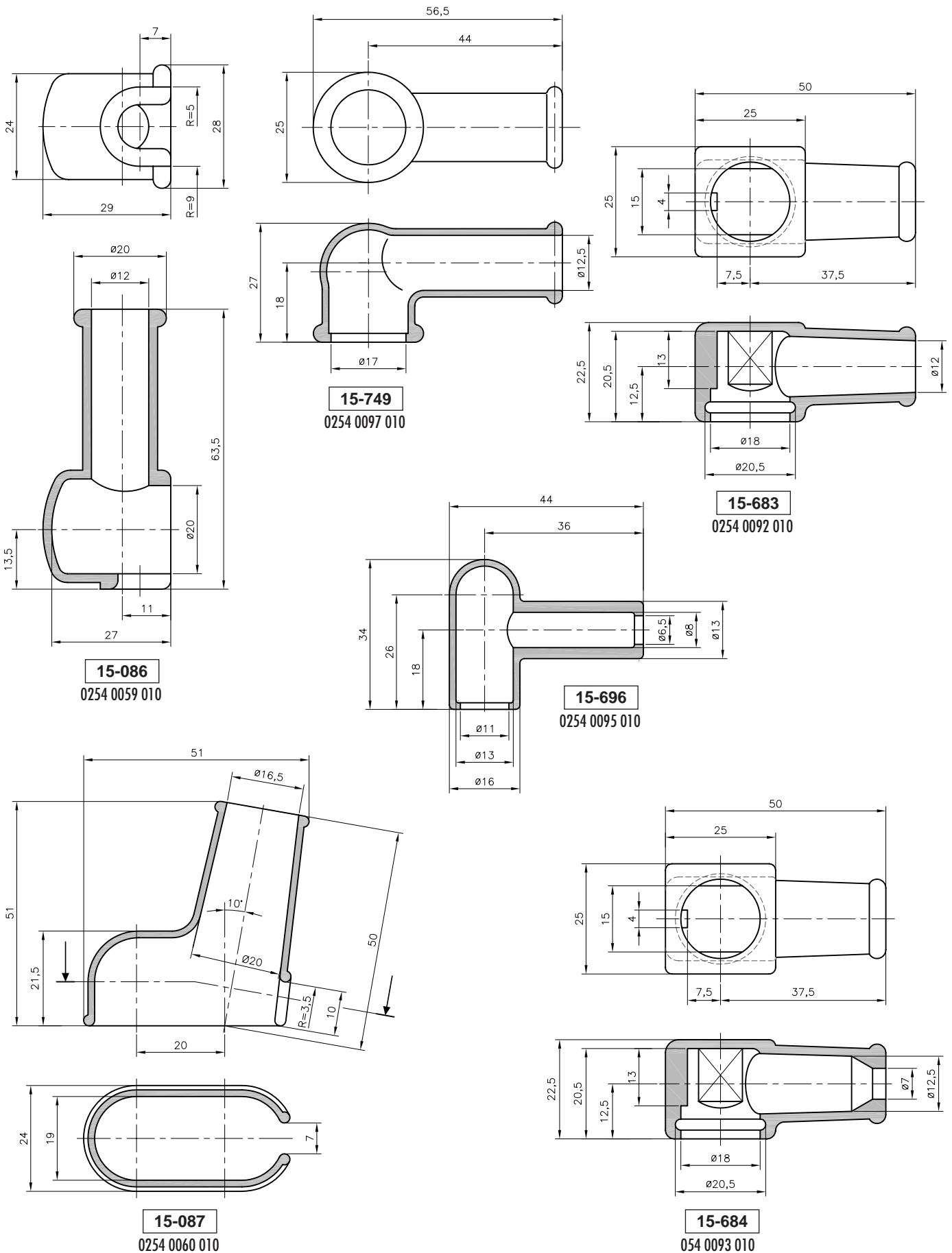



type	article number		type	article number		type	article number	
15-018	0254 0001 010	100	15-151	0254 0021 010	100	15-533	0254 0083 010	100
15-020	0254 0002 010	100	15-156	0254 0022 010	100	15-560	0254 0043 010	100
15-021	0254 0024 010	100	15-199*	0254 0032 010	100	15-605	0254 0084 010	100
15-023	0254 0003 010	100	15-307	0254 0034 010	100	15-615	0254 0044 010	100
15-026	0254 0004 010	100	15-326	0254 0036 010	100	15-630**	0254 0049 010	100
15-051	0254 0008 010	100	15-327	0254 0065 010	100	15-650	0254 0050 010	100
15-054	0254 0011 010	100	15-344	0254 0037 010	100	15-657	0254 0035 010	100
15-068	0254 0027 010	100	15-360	0254 0038 010	100	15-685	0254 0029 010	100
15-089	0254 0012 010	100	15-385	0254 0039 010	100	15-717	0254 0066 010	100
15-092	0254 0061 010	100	15-386	0254 0040 010	100	15-718	0254 0067 010	100
15-142	0254 0013 010	100	15-388	0254 0041 010	100	15-753	0254 0124 010	100
15-145	0254 0014 010	100	15-520	0254 0042 010	100	15-793*	0254 0126 010	100
15-149	0254 0015 010	100						

* Nitrile rubber
** EPDM rubber

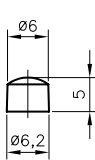

15-021
0254 0024 010

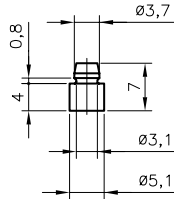

15-199
0254 0032 010

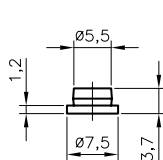

15-657
0254 0035 010

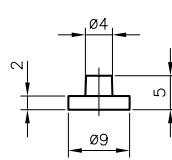

15-560
0254 0043 010

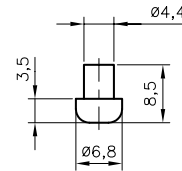

15-388
0254 0041 010

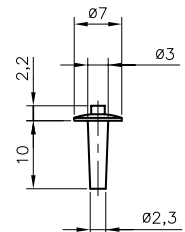

15-793
0254 0126 010

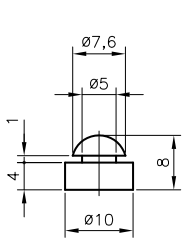

15-386
0254 0040 010

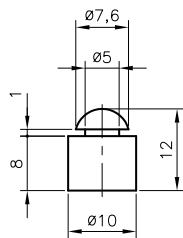

15-385
0254 0039 010

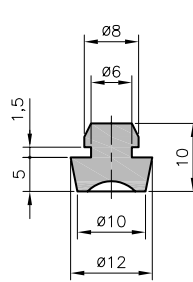

15-018
0254 0001 010

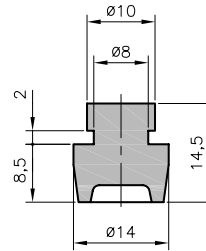

15-142
0254 0013 010

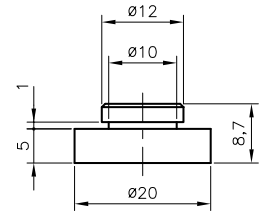

15-520
0254 0042 010

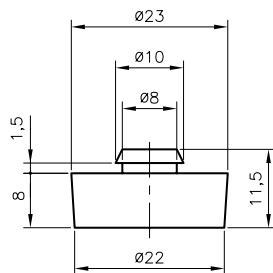

15-344
0254 0037 010

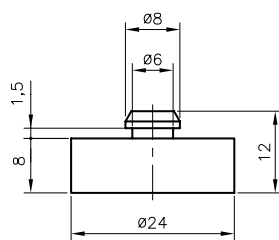

15-717
0254 0066 010

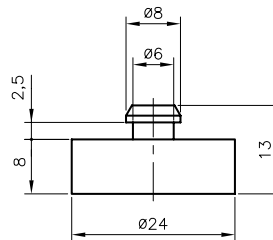

15-718
0254 0067 010

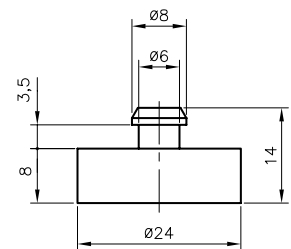

15-685
0254 0029 010

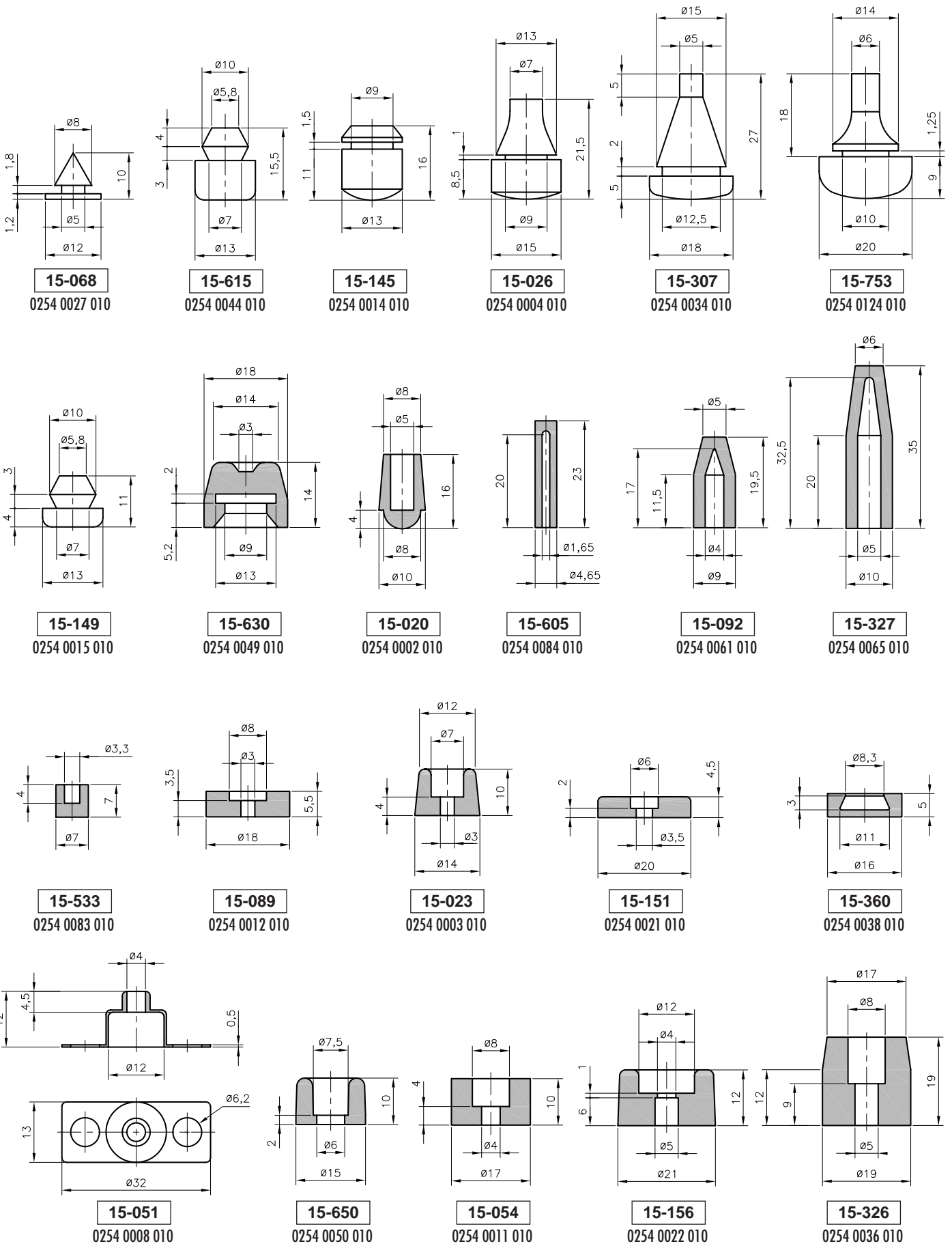

HELAVIA® flanged and bushed grommets in black polychloroprene rubber



HELAVIA®
-30 to +90°C



type	article number		type	article number		type	article number	
15-001	0253 0002 010	100	15-162	0253 0032 010	100	15-653	0257 0043 010	100
15-003	0254 0023 010	100	15-393	0257 0013 010	100	15-654	0257 0044 010	100
15-004	0254 0045 010	100	15-395	0257 0014 010	100	15-664	0257 0050 010	100
15-038	0254 0025 010	100	15-398	0257 0015 010	100	15-665	0257 0051 010	100
15-058	0254 0026 010	100	15-399	0257 0016 010	100	15-678	0254 0088 010	50
15-060	0254 0046 010	100	15-537	0254 0087 010	100	15-716	0254 0005 010	100

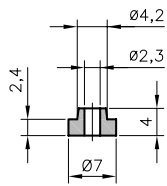

15-537
0254 0087 010

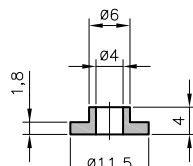

15-058
0254 0026 010

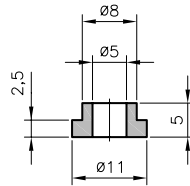

15-398
0257 0015 010

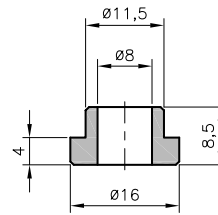

15-399
0257 0016 010

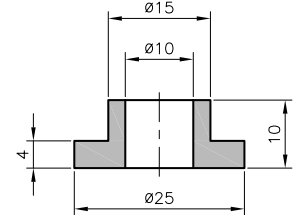

15-395
0257 0014 010

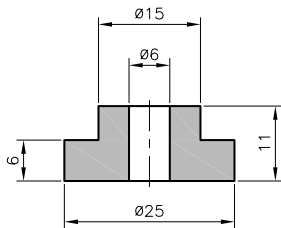

15-003
0254 0023 010

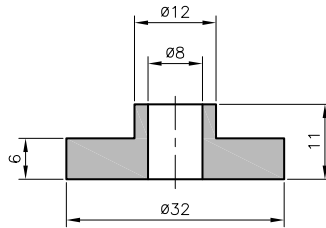

15-038
0254 0025 010

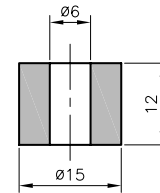

15-004
0254 0045 010

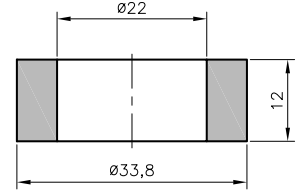

15-678
0254 0088 010

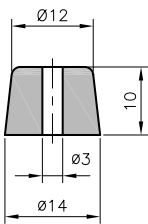

15-716
0254 0005 010

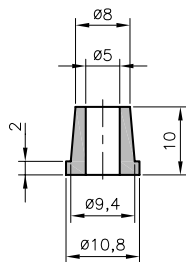

15-664
0257 0050 010

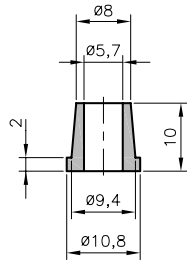

15-665
0257 0051 010

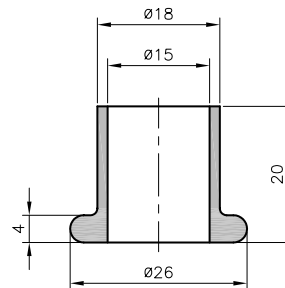

15-393
0257 0013 010

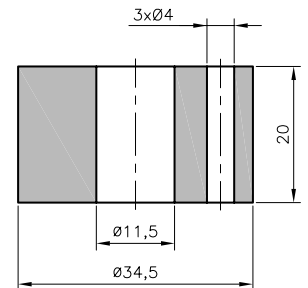

15-001
0253 0002 010

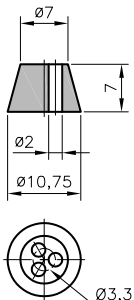

15-162
0253 0032 010

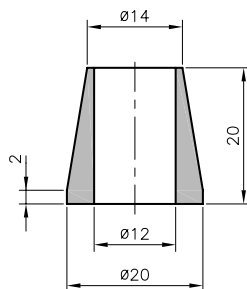

15-654
0257 0044 010

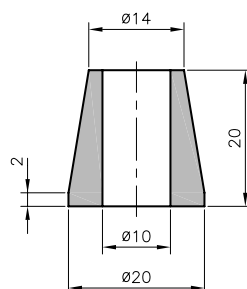

15-653
0257 0043 010

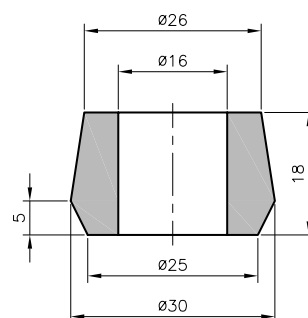

15-060
0254 0046 010

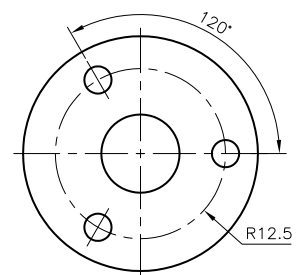

SES-STERLING specializes mainly in Polychloroprene (Neoprene / Baypren). For special needs, other qualities can be produced (e.g. EPDM, NBR or Silicone).

SES-STERLING always seeks to extend its programme of mouldings for the electrical industry. Many new designs are added each year where we have the customer's cooperation and where a small contribution is made by the original customer towards the tool costs.

All sales and manufacturing rights remain the property of the SES-STERLING. SES-STERLING executes all the orders it receives for new items, without research property rights filed. The manufacture and sale of new items are therefore the unique responsibility of the Company who places the order.



**Helsinki**

tel. +358 9 540 4940
automation@klinkmann.fi

Yekaterinburg

tel. +7 343 287 19 19
yekaterinburg@klinkmann.spb.ru

Vilnius

tel. +370 5 215 1646
post@klinkmann.lt

St. Petersburg

tel. +7 812 327 3752
klinkmann@klinkmann.spb.ru

Samara

tel. +7 846 273 95 85
samara@klinkmann.spb.ru

Tallinn

tel. +372 668 4500
klinkmann.est@klinkmann.ee

Moscow

tel. +7 495 641 1616
moscow@klinkmann.spb.ru

Kiev

tel. +38 044 495 33 40
klinkmann@klinkmann.kiev.ua

Riga

tel. +371 6738 1617
klinkmann@klinkmann.lv

Minsk

tel. +375 17 200 0876
minsk@klinkmann.com