

PG-FP5

Flash Memory Programmer

User's Manual

All information contained in these materials, including products and product specifications, represents information on the product at the time of publication and is subject to change by Renesas Electronics Corp. without notice. Please review the latest information published by Renesas Electronics Corp. through various means, including the Renesas Electronics Corp. website (<http://www.renesas.com>).

Notice

1. All information included in this document is current as of the date this document is issued. Such information, however, is subject to change without any prior notice. Before purchasing or using any Renesas Electronics products listed herein, please confirm the latest product information with a Renesas Electronics sales office. Also, please pay regular and careful attention to additional and different information to be disclosed by Renesas Electronics such as that disclosed through our website.
2. Renesas Electronics does not assume any liability for infringement of patents, copyrights, or other intellectual property rights of third parties by or arising from the use of Renesas Electronics products or technical information described in this document. No license, express, implied or otherwise, is granted hereby under any patents, copyrights or other intellectual property rights of Renesas Electronics or others.
3. You should not alter, modify, copy, or otherwise misappropriate any Renesas Electronics product, whether in whole or in part.
4. Descriptions of circuits, software and other related information in this document are provided only to illustrate the operation of semiconductor products and application examples. You are fully responsible for the incorporation of these circuits, software, and information in the design of your equipment. Renesas Electronics assumes no responsibility for any losses incurred by you or third parties arising from the use of these circuits, software, or information.
5. When exporting the products or technology described in this document, you should comply with the applicable export control laws and regulations and follow the procedures required by such laws and regulations. You should not use Renesas Electronics products or the technology described in this document for any purpose relating to military applications or use by the military, including but not limited to the development of weapons of mass destruction. Renesas Electronics products and technology may not be used for or incorporated into any products or systems whose manufacture, use, or sale is prohibited under any applicable domestic or foreign laws or regulations.
6. Renesas Electronics has used reasonable care in preparing the information included in this document, but Renesas Electronics does not warrant that such information is error free. Renesas Electronics assumes no liability whatsoever for any damages incurred by you resulting from errors in or omissions from the information included herein.
7. Renesas Electronics products are classified according to the following three quality grades: “Standard”, “High Quality”, and “Specific”. The recommended applications for each Renesas Electronics product depends on the product’s quality grade, as indicated below. You must check the quality grade of each Renesas Electronics product before using it in a particular application. You may not use any Renesas Electronics product for any application categorized as “Specific” without the prior written consent of Renesas Electronics. Further, you may not use any Renesas Electronics product for any application for which it is not intended without the prior written consent of Renesas Electronics. Renesas Electronics shall not be in any way liable for any damages or losses incurred by you or third parties arising from the use of any Renesas Electronics product for an application categorized as “Specific” or for which the product is not intended where you have failed to obtain the prior written consent of Renesas Electronics. The quality grade of each Renesas Electronics product is “Standard” unless otherwise expressly specified in a Renesas Electronics data sheets or data books, etc.
 - “Standard”: Computers; office equipment; communications equipment; test and measurement equipment; audio and visual equipment; home electronic appliances; machine tools; personal electronic equipment; and industrial robots.
 - “High Quality”: Transportation equipment (automobiles, trains, ships, etc.); traffic control systems; anti-disaster systems; anti-crime systems; safety equipment; and medical equipment not specifically designed for life support.
 - “Specific”: Aircraft; aerospace equipment; submersible repeaters; nuclear reactor control systems; medical equipment or systems for life support (e.g. artificial life support devices or systems), surgical implantations, or healthcare intervention (e.g. excision, etc.), and any other applications or purposes that pose a direct threat to human life.
8. You should use the Renesas Electronics products described in this document within the range specified by Renesas Electronics, especially with respect to the maximum rating, operating supply voltage range, movement power voltage range, heat radiation characteristics, installation and other product characteristics. Renesas Electronics shall have no liability for malfunctions or damages arising out of the use of Renesas Electronics products beyond such specified ranges.
9. Although Renesas Electronics endeavors to improve the quality and reliability of its products, semiconductor products have specific characteristics such as the occurrence of failure at a certain rate and malfunctions under certain use conditions. Further, Renesas Electronics products are not subject to radiation resistance design. Please be sure to implement safety measures to guard them against the possibility of physical injury, and injury or damage caused by fire in the event of the failure of a Renesas Electronics product, such as safety design for hardware and software including but not limited to redundancy, fire control and malfunction prevention, appropriate treatment for aging degradation or any other appropriate measures. Because the evaluation of microcomputer software alone is very difficult, please evaluate the safety of the final products or system manufactured by you.
10. Please contact a Renesas Electronics sales office for details as to environmental matters such as the environmental compatibility of each Renesas Electronics product. Please use Renesas Electronics products in compliance with all applicable laws and regulations that regulate the inclusion or use of controlled substances, including without limitation, the EU RoHS Directive. Renesas Electronics assumes no liability for damages or losses occurring as a result of your noncompliance with applicable laws and regulations.
11. This document may not be reproduced or duplicated, in any form, in whole or in part, without prior written consent of Renesas Electronics.
12. Please contact a Renesas Electronics sales office if you have any questions regarding the information contained in this document or Renesas Electronics products, or if you have any other inquiries.

(Note 1) “Renesas Electronics” as used in this document means Renesas Electronics Corporation and also includes its majority-owned subsidiaries.

(Note 2) “Renesas Electronics product(s)” means any product developed or manufactured by or for Renesas Electronics.

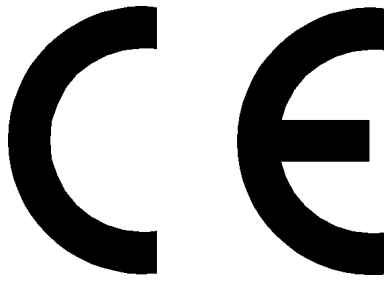

This equipment complies with the EMC protection requirements

WARNING

This is a 'Class A' (EN 55022: 1998) equipment. This equipment can cause radio frequency noise when used in the residential area. In such cases, the user/operator of the equipment may be required to take appropriate countermeasures under his responsibility.

EEDT-ST-001-11

CAUTION

This equipment should be handled like a CMOS semiconductor device. The user must take all precautions to avoid build-up of static electricity while working with this equipment. All test and measurement tool including the workbench must be grounded. The user/operator must be grounded using the wrist strap. The connectors and/or device pins should not be touched with bare hands.

EEDT-ST-004-10

For customers in the European Union only



Redemption of Waste Electrical and Electronic Equipment (WEEE) in accordance with legal regulations applicable in the European Union only: This equipment (including all accessories) is not intended for household use. After use the equipment cannot be disposed of as household waste. Renesas Electronics Europe GmbH offers to take back the equipment. All you need to do is register at <http://www.renesas.eu/weee>.

EMC regulation (VCCI, FCC)

Please read the following notes about EMC regulation before using.

電波障害自主規制について (JAPAN ONLY)

この装置は、クラスA情報技術装置です。この装置を家庭環境で使用すると電波妨害を引き起こすことがあります。この場合には使用者が適切な対策を講ずるよう要求されることがあります。

VCCI-A

About FCC

Note: This equipment has been tested and found to comply with the limits for a Class A digital device, pursuant to part 15 of the FCC Rules. These limits are designed to provide reasonable protection against harmful interference when the equipment is operated in a commercial environment. This equipment generates, uses and can radiate radio frequency energy and, if not installed and used in accordance with the instruction manual, may cause harmful interference to radio communications. Operation of this equipment in a residential area is likely to cause harmful interference in which case the user will be required to correct the interference at his own expense.

Modifications not expressly approved by the manufacturer could void the user's authority to operated the equipment under FCC rules.

CAUTION:

When using this product, please use AC adapter (QB-COMMON-PW) which comply with the standard of VCCI and FCC.

General Precautions on Handling This Product

1. Circumstances not covered by product guarantee

- If the product was disassembled, altered, or repaired by the customer
- If it was dropped, broken, or given another strong shock
- Use at overvoltage, use outside guaranteed temperature range, storing outside guaranteed temperature range
- If power was turned on while the AC adapter, interface cable, or connection to the target system was in an unsatisfactory state
- If the cable of the AC adapter, the interface cable, the target cable, or the like was bent or pulled excessively
- If the product got wet
- If the product and target system were connected while a potential difference existed between the GND of the product and the GND of the target system
- If a connector or cable was connected or disconnected while power was being supplied to the product
- If an excessive load was applied to a connector or cable
- If the product is used or stored in an environment where an electrostatic or electrical noise is likely to occur

2. Safety precautions

- If used for a long time, the product may become hot (50 to 60°C). Be careful of low temperature burns and other dangers due to the product becoming hot.
- Be careful of electrical shock. There is a danger of electrical shock if the product is used as described above in 1 Circumstances not covered by product guarantee.

How to Use This Manual

Target Readers This manual is intended for users who use the PG-FP5 when designing and developing a system using a Renesas Electronics on-chip flash memory microcontroller.

Purpose This manual is intended to give users an understanding of the basic specifications and correct use of the PG-FP5. By using the PG-FP5, programs can be easily erased from or written to the flash memory of a Renesas Electronics on-chip flash memory microcontroller, or can be verified on Windows™ screens, while the microcontroller is mounted on the user board.

Organization This manual includes the following sections.

- Overview
- Hardware installation
- Software installation
- Programming GUI usage
- Example of operation using programming GUI
- PG-FP5 operation in standalone mode
- Usage the remote connector
- Usage communication commands
- Connectors and cables
- Notes on target system designs
- Target interface specifications
- Troubleshooting
- Messages
- Supplementary information
- Electrical specifications of target interface
- Electrical specifications of remote interface

How to Read This Manual It is assumed that the readers of this manual have general knowledge of electricity, logic circuits, and microcontrollers.

To understand the overall operation

→ Read this manual according to the **CONTENTS**.

The mark <R> shows major revised points. The revised points can be easily searched by copying an "<R>" in the PDF file and specifying it in the "Find what:" field.

To know the cautions of target system

→ See the **CHAPTER 9 CONNECTORS AND CABLES**, **CHAPTER 10 NOTES ON TARGET SYSTEM DESIGNS**, and **CHAPTER 11 SPECIFICATION OF TARGET INTERFACE CIRCUITS**. Also see the user's manual for each target device.

Conventions**Note:** Footnote for item marked with **Note** in the text.**Caution:** Information requiring particular attention**Remark:** Supplementary information

Numeral representation: Binary ... xxxx or xxxxB

Decimal ... xxxx

Hexadecimal ... 0xxxxx or xxxxh

“ ”: Any character or item on screen

[]: Name of commands, dialog boxes or area

<R> **Terminology**

The meanings of the terms used in this manual are as follows.

Term	Meaning
FP5	Abbreviation of the flash memory programmer PG-FP5
Programming GUI	Windows application to operate FP5 using programming GUI
Target device	Renesas Electronics on-chip flash memory microcontroller
Target system	User-designed board on which target device is mounted
Program adapter ^{Note1}	Conversion adapter to write programs to target device
PR5 file	Abbreviation of the parameter file for the PG-FP5. The parameter file has parameter information required to write in the flash memory of the target microcontroller. The extension of the file is "*.pr5". Do not change the data in the file. If the file is changed, operation of the FP5 is not guaranteed.
ESF file	Abbreviation of the setting file for the PG-FP5. The setting file stores information required for writing. For the FP5, settings regarding the writing environment such as target devices and operation option are stored. The extension of the file is "*.esf". Do not change the data in the file. If the file is changed, operation of the FP5 is not guaranteed.
Program file	The program file is the program written to the microcontroller. For the FP5, the following file formats are supported. <RL78, 78K, V850> a. Intel HEX format HEX file b. Intel HEX format HCUHEX file c. Motorola S format HEX file d. Motorola S format HCUHEX file <RX family, R8C family, SuperH family> a. Intel HEX format HEX file b. Motorola S format HEX file c. DDI file Notes 1. Addresses may not be consecutive, but they must be in ascending order. Free space will be filled with "FFH" upon download to the FP5. When download is performed with the programming GUI, it has the function to sort addresses in ascending order. 2. For details on the formats, refer to "How to Order ROM Code: Information (C10302E)." 3. The program file name does not support 2-byte characters.
Flash options	General term for security settings, rewrite protection settings, reset vector handling function settings, option byte settings, and on-chip debug security ID settings
Option data	General term for flash options, wide-voltage mode, and full-speed mode ^{Note2}
HEX file	A HEX file of Intel HEX format type or Motorola HEX format type without option data
HCUHEX file	A HEX file that integrates option data into a HEX file generated by using the HEX Consolidation Utility (HCU), which is used to generate ROM code for flash memory products whose flash memories are pre-written by Renesas Electronics

DDI file	File in which data in multiple flash areas generated by Flash Development Toolkit is integrated.
Flash Development Toolkit	Flash Development Toolkit is a software to write in the flash memory of the Renesas microcontroller with on-chip flash. For details, refer to the following websites. Japanese version: http://japan.renesas.com/fdt English version: http://www.renesas.com/fdt
INI file	File in which settings of the programming GUI are stored. The file is saved when the programming GUI is closed. The file name is "FP5.ini". Storage location in Windows XP C:\Windows Storage location in Windows Vista , Windows 7 C:\Users\{user name}\AppData \Local\VirtualStore\Windows
OCD security ID	Abbreviation of the on-chip debug security ID. Security function for on-chip debugging of the microcontroller.
ID code	Function to prohibit read, write, or erasure from the host. The control code on the ROM and ID code are used to enable or disable ID code protect and to determine ID code protect.
Lock bit	Function to prevent data write/erasure by mistake. Write and erasure can be prohibited (locked) for each block.
Signature	Information about the microcontroller (microcontroller name, firmware version)

- Notes**
1. The program adapter (FA-xxxx) is a product of Naito Densei Machida Mfg. Co., Ltd.
If you have any questions about the FA adapter board, contact Naito Densei Machida Mfg. Co., Ltd. (Tel: +81-42-750-4172).
 2. The functions that can be used differ depending on the target device.

CONTENTS

CHAPTER 1 OVERVIEW	13
1.1 Features.....	13
1.2 Writing Quality	13
1.3 Supported Devices	13
1.4 FP5 System Overview	14
1.5 Operating Environment.....	16
1.5.1 Hardware environment.....	16
1.5.2 Software environment	16
1.6 Hardware Specifications.....	17
1.7 AC Adapters for PG-FP5.....	18
1.8 HCUHEX Files	19
CHAPTER 2 HARDWARE CONFIGURATION	20
2.1 Package Contents	20
2.2 System Configuration	20
2.2.1 Host machine.....	21
2.2.2 Serial cable	21
2.2.3 USB cable.....	21
2.2.4 AC adapter.....	21
2.2.5 Target cable.....	21
2.2.6 GND cable	21
2.2.7 Target system	21
2.2.8 Program adapter	21
2.3 Names and Functions on Main Unit	22
2.3.1 FP5 control panel.....	22
2.3.2 FP5 connectors.....	23
CHAPTER 3 SOFTWARE INSTALLATION	26
3.1 Obtaining Software.....	26
3.2 Installation.....	26
3.2.1 Notes on installation.....	27
3.3 Uninstallation	28
3.4 Updating Programming GUI, Firmware and FPGA	28
3.4.1 Checking the current version	29
3.4.2 Installation of programming GUI	29
3.4.3 Installation of firmware update	30
3.4.4 Installation of FPGA update	33
CHAPTER 4 PROGRAMMING GUI USAGE.....	38
4.1 Introduction.....	38
4.2 Startup of Programming GUI.....	38
4.3 Menu Bar	42
4.3.1 [F]ile menu	42
4.3.2 [P]rogrammer] menu	52
4.3.3 [D]evice] menu	69
4.3.4 [H]elp] menu	109
4.4 Toolbar.....	110
4.5 Action Log Window	111
4.6 Programming Parameter Window.....	112

4.7	Status Bar.....	113
4.8	Hint Bar.....	114
CHAPTER 5 EXAMPLE OF OPERATION USING PROGRAMMING GUI		115
CHAPTER 6 USAGE IN STANDALONE MODE.....		130
6.1	Before Starting Standalone Operation.....	130
6.2	Description of Buttons, Message Display and Status LEDs.....	130
6.3	Standalone Operation Menu.....	132
6.3.1	[Commands] menu.....	132
6.3.2	[Type Setting] menu.....	134
6.3.3	[Option Setting] menu	135
6.3.4	[Voltage Setting] menu.....	137
6.3.5	[Utility/Misc.] menu.....	138
CHAPTER 7 USAGE THE REMOTE CONNECTOR.....		139
7.1	Remote Interface Mode.....	139
7.2	Remote Connector Pins.....	139
7.3	Equivalence Circuits	141
7.4	External Connection Example.....	142
CHAPTER 8 USAGE COMMUNICATION COMMANDS		143
8.1	Starting the Communications Software.....	143
8.2	Command List.....	146
8.3	Description of Commands.....	148
8.4	Description of FP5 Control Commands	149
8.4.1	autocon command	149
8.4.2	brt command.....	150
8.4.3	conf command	151
8.4.4	downprm command	154
8.4.5	downset command.....	155
8.4.6	fcks command.....	156
8.4.7	files command.....	157
8.4.8	fpga_up command	158
8.4.9	hex command	159
8.4.10	hlp command	160
8.4.11	lod command	161
8.4.12	prm command.....	162
8.4.13	progarea command.....	163
8.4.14	pwr_off command	164
8.4.15	res command	165
8.4.16	security command.....	165
8.4.17	selftest command.....	166
8.4.18	sound command	167
8.4.19	srec command	168
8.4.20	trc command.....	169
8.4.21	upprm command.....	170
8.4.22	upset command	171
8.4.23	ver command	171
8.4.24	version_up command.....	172
8.5	Description of The FP5 Device Commands	174
8.5.1	bln command	174

8.5.2	con command	175
8.5.3	dcon command	175
8.5.4	ep/epv command	176
8.5.5	ers command	177
8.5.6	gid command	178
8.5.7	gob command	179
8.5.8	gos command	180
8.5.9	gsc command	181
8.5.10	idc command	182
8.5.11	opb command	183
8.5.12	prg command	184
8.5.13	read command	185
8.5.14	scf command	186
8.5.15	sig command	187
8.5.16	slb command	188
8.5.17	sum command	189
8.5.18	vrf command	190
CHAPTER 9 CONNECTORS AND CABLES		191
9.1	Power Supply Connector	191
9.2	Serial Connector	192
9.2.1	Serial cable	193
9.3	USB Connector	193
9.3.1	USB cable	193
9.4	Target Connector	194
9.4.1	Target Cable (16-pin type)	195
9.4.2	Target cable (14-pin type)	196
9.5	GND Connector	198
9.5.1	GND cable	198
9.6	Remote Connector	198
CHAPTER 10 NOTES ON TARGET SYSTEM DESIGN		199
CHAPTER 11 SPECIFICATIONS OF TARGET INTERFACE CIRCUITS		209
11.1	SO/TxD, $\overline{\text{R}\overline{\text{E}}\overline{\text{S}}\overline{\text{E}}\overline{\text{T}}}$ and SCK	209
11.2	SI/RxD and H/S	209
11.3	CLK	210
11.4	FLMD0 and FLMD1	210
11.5	V _{DD} and V _{DD2}	211
11.6	V _{PP}	211
CHAPTER 12 TROUBLESHOOTING		212
12.1	Problems During Startup	212
12.2	Problems During Operation	213
APPENDIX A MESSAGES		216
A.1	Message Format	216
A.2	Error/Warning Dialog Boxes for Programming GUI Operation	217
A.3	Information Dialog Boxes for Programming GUI Operation	220
A.4	Error Messages Displayed in FP5 Message Display	223
APPENDIX B SUPPLEMENTARY INFORMATION		226

APPENDIX C ELECTRICAL SPECIFICATIONS OF TARGET INTERFACE	229
C.1 Absolute Maximum Ratings (T_A = 0 to 40 °C)	229
C.2 DC Characteristics (T_A = 0 to 40 °C)	230
C.3 AC Characteristics (T_A = 0 to 40 °C, C = 0 pF (Unloaded Condition))	231
C.3.1 CLK output characteristics (T _A = 0 to 40 °C, C = 0 pF (unloaded condition)).....	233
C.3.2 Serial transfer timing (T _A = 0 to 40 °C, C = 0 pF (unloaded condition)).....	234
APPENDIX D ELECTRICAL SPECIFICATIONS OF REMOTE INTERFACE	235
D.1 Absolute Maximum Ratings (T_A = 0 to 40 °C)	235
D.2 DC Characteristics T_A = 0 to 40 °C, C = 0 pF (Unloaded Condition))	236
D.3 AC Characteristics (T_A = 0 to 40 °C, C = 0 pF (Unloaded Condition))	237
D.3.1 Standard mode	237
D.3.2 Bank mode.....	239
D.3.3 Simple mode.....	241

CHAPTER 1 OVERVIEW

The FP5 is a tool that erases, writes and verifies programs on a Renesas Electronics on-chip flash memory microcontroller on the target system or program adapter.

1.1 Features

- Compatible with remote operation for FP5 from an external control device
- Compatible with communications commands operated by the FP5 command through RS-232C
- The customization and security settings of the FP5 unit can be changed with the FP5 Manager function
- Supports on-chip 2-power-supply flash memory microcontrollers and single-power-supply on-chip flash memory microcontrollers
- Supports flash memory programming through the programming GUI using the host machine (programming GUI operation) and operation in standalone (standalone operation)
- Supports on-board programming through which programs are written with the target device mounted on the target system, and off-board programming through which programs are written via a program adapter without the target device mounted on the target system
- Program files can be saved in the 16 MB flash memory in the FP5 (divided by 4, in 4 MB units or divided by 8, in 2 MB units)
- Device-specific parameters required for programming can be saved in the FP5 internal flash memory by using the parameter file (PR5 file), together with programming settings (ESF file).
- Multiple program files, PR5 files and ESF files can be saved
- Supports CSI, CSI + HS, UART, I²C and PORT as target device interfaces
- Can supply V_{DD} and clocks to the target device
- Supports USB interface and serial interface (RS-232C) as a host interface
- Supports self-testing function
- Can update firmware and FPGA
- Compact and lightweight

1.2 Writing Quality

Thoroughly confirm, verify and evaluate the following points before using the FP5, in order to improve the writing quality.

- Design circuits as described in the user's manual for the target device and the FP5.
- Use the device and the FP5 as described in the user's manual for each product.
- The power supplied to the target device is stable.

<R> 1.3 Supported Devices

The FP5 supports on-chip 2-power-supply flash memory microcontrollers and on-chip single-power-supply flash memory microcontrollers.

FP5 parameter files (PR5 files) corresponding to the supported devices are posted on the following website.

URLs

- Japanese version: http://japan.renesas.com/pg_fp5
- English version (Except for Europe area): http://www.renesas.com/pg_fp5
- English version (For Europe area): <http://www.renesas.eu/update> → Section PG-FP5-EE

1.4 FP5 System Overview

The FP5 system overview is shown in the following diagrams.

Figure 1-1. FP5 Connection Image

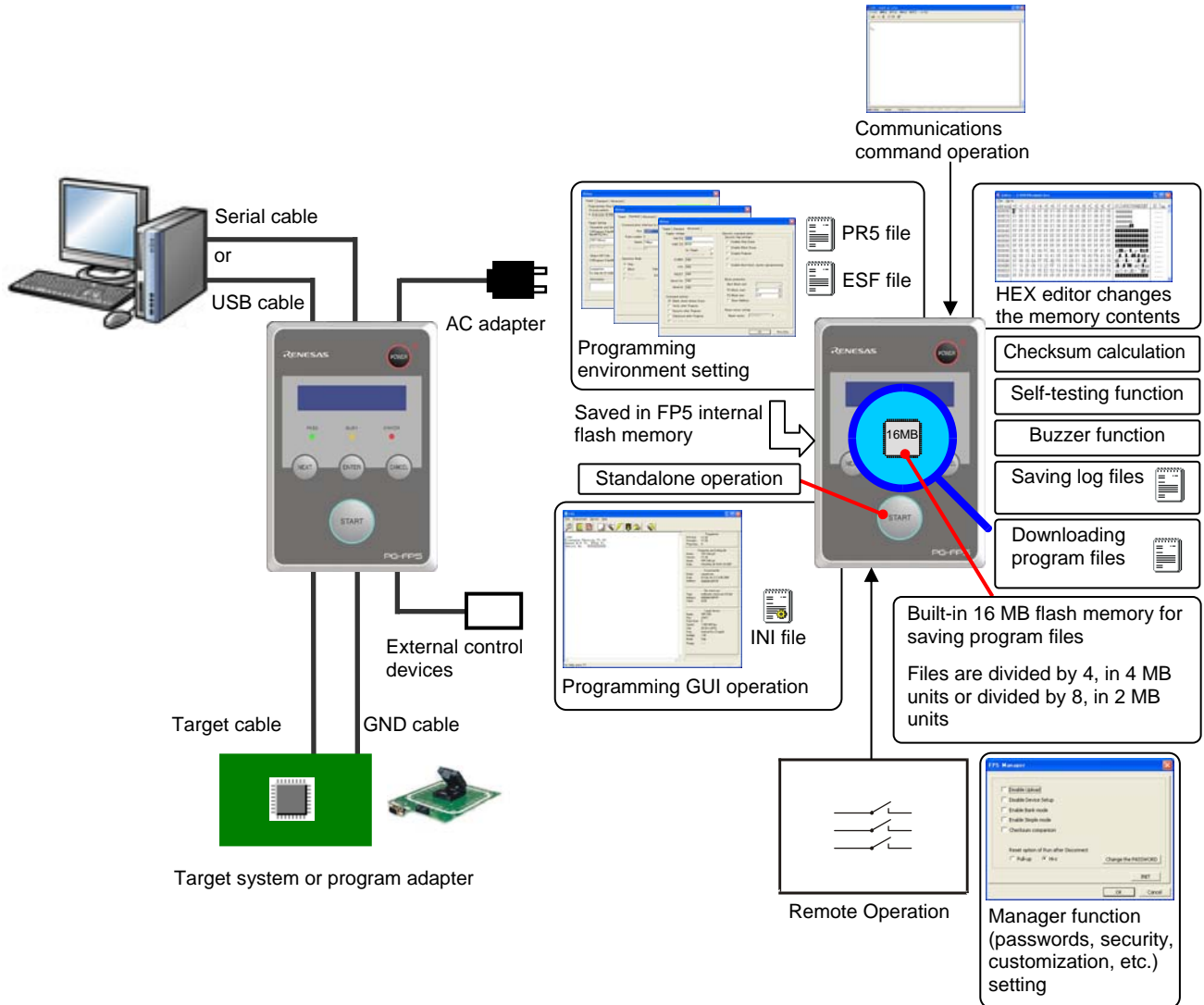

<Programming GUI operation>

<R> The following operations can be performed with the programming GUI. For USB connection, the USB driver must be installed. The settings on the host machine are saved in an INI file.

- ESF file creation
- Downloading program files, PR5 files and ESF files (saved into FP5 internal flash memory)
- Saving log files
- Editing program files (by using HEX editor)
- Checksum calculation
- Programming command execution
- Execution of self-testing function
- Manager function (passwords, security, customization, etc.) setting

<Standalone operation>

The FP5 can operate in standalone mode, whereby commands such as [Erase], [Program] and [Autoprocedure(E.P.)] can be executed without using the host machine. It is suitable for use in production lines during mass production or upgrading programs in the field.

The following can be performed in standalone operation.

- Execute programming command
- Confirm contents of each downloaded file

<Communications Command Operation>

FP5 can be operated by communications commands from the host machine.

<Remote Operation>

Writing and PASS/ERROR displays can be operated and confirmed from external control devices.

<FP5 internal flash memory>

The FP5 has a 16 MB flash memory area for saving program files. This memory area can be used as four 4 MB programming areas (Area 0 to Area 3) or eight independent 2 MB programming areas (Area 0 to Area 7). Program files can be downloaded to each programming area, and which file, PR5 or ESF, is to be saved is selectable in programming area units. That is, files can be individually downloaded in each programming area, and the area used can also be selected individually. Program files, PR5 files and ESF files are retained even if the FP5 power is turned off.

Downloaded data will be self-tested for accuracy when the FP5 is started, during downloads and when programming areas are changed.

<Notification function>

When Autoprocedure (E.P.) is executed, whether execution is completed normally is indicated by beeps.

<Checksum calculation>

Checksum calculation for the download program files is possible.

1.5 Operating Environment

This section explains the following items with respect to the operating environment.

- Hardware environment
- Software environment

1.5.1 Hardware environment

- <R>
- (1) Host machines
 - PC/AT™ compatible
 - Equipped with USB 2.0 ports (compatible with 1.1)
 - Equipped with RS-232C serial ports
 - (2) Hardware option tools that support FP5
 - Target board QB-xxxx-TB (a product of Renesas Electronics, sold separately)
 - Program adapter FA-xxxx (a product of Naito Densei Machida Mfg. Co., Ltd., sold separately)
 - IC clip type target cable FA-CLIP (a product of Naito Densei Machida Mfg. Co., Ltd., sold separately)
 - Switch jig FL-SW/FP5 (a product of Naito Densei Machida Mfg. Co., Ltd., sold separately)
 - Buffer board FL-BUF (a product of Naito Densei Machida Mfg. Co., Ltd., sold separately)
 - Long target cable FL-TCxxxx (name undetermined, a product of Naito Densei Machida Mfg. Co., Ltd., sold separately)
- <R>
- Conversion adapter FL-RL78/FP5 (a product of Naito Densei Machida Mfg. Co., Ltd., sold separately) used when $VDD \neq EVDD$ for the RL78 family

1.5.2 Software environment

- <R>
- (1) OS (either of the following)
 - Windows XP (32-bit edition)
 - Windows Vista™ (32-bit edition, 64-bit edition)
 - Windows 7 (32-bit edition, 64-bit edition)
 - Microsoft .NET Framework 3.5 SP1 + Language pack
 - Microsoft Visual C++ 2008 SP1 Redistributable Package (x86)
 - Internet Explorer® 6.0 or later
 - (2) Software option tools that support FP5
 - Simplified control software for production line (FPterm) (a product of Naito Densei Machida Mfg. Co., Ltd., sold separately)^{Note}
 - Gang-supported software for production line (FW-GFP) (a product of Naito Densei Machida Mfg. Co., Ltd., sold separately)

Note Under development

1.6 Hardware Specifications

Table 1-1. Hardware Specifications

Hardware	Items	Specifications
FP5 main unit	Operating power supply	Supplied via AC adapter (15 V)
	Operating environment condition	Temperature: ± 0 to $+40^{\circ}\text{C}$ Humidity: 10% to 80% RH (no condensation)
	Storage environment condition	Temperature: -15 to $+60^{\circ}\text{C}$ Humidity: 10% to 80% RH (no condensation)
	Package size	140 × 90 × 30 mm (not including projections)
	Weight	Approximately 230 g
	Internal flash memory	Program file save area (16 MB) Other (PR5 file save area, ESF file saved area, firmware area, and FPGA area)
	Operation mode	Programming GUI operation, standalone operation, remote operation, communication command operation
AC adapter	Specifications	AC adapters used in each region ^{Note 3}
<R> Host machine interface	Target host machine	PC/AT compatible
	USB connector	Type mini-B, USB 2.0 (compatible with 1.1)
	USB cable	Approximately 2 m
	Serial connector	9-pin D-SUB male connector for RS-232C @ 9600, 19200, 38400, 57600, 115200 bps
	Serial cable	Approximately 3 m (cross cable)
<R> Target interface ^{Note 1}	Target connector	Connector: 15-pin HD-SUB female connector Protected function: Internal over-voltage input protection circuit Supported communication mode and rate: 3-wire serial I/O (CSI) (5.0 MHz max.) 3-wire serial I/O with handshake (CSI + HS) (5.0 MHz max.) Pseudo 3-wire I/O (2.0 kHz max.) UART (1 Mbps max.) I ² C (100 kHz max.)
	Target cable	Two cables: 16-pin type and 14-pin type. Cable length: Approximately 42 cm
	Power supply ^{Note 2}	1.2 to 5.5 V
	Power supply detection	Available. Current consumption: 1 mA or less
	CPU clock supply	1 MHz, 2 MHz, 4 MHz, 5 MHz, 6 MHz, 8 MHz, 9 MHz, 10 MHz, 12 MHz, 16 MHz, 20 MHz
	GND cable	Approximately 1 m
Remote interface	Remote connector	15-pin D-SUB female connector

Notes 1. The maximum communication speed in the interface may vary depending on the device and environment used.

2. V_{DD} for the target system is supplied for the purpose of supplying power to the target device through which writing is performed, so the specification cannot secure sufficient capacity to operate the target system. Use the power source on the target system when performing on-board programming.

3. The AC adapter differs depending on the region where the product is being used. For details, see **Table 1-2 AC Adapters for PG-FP5 Used in Each Region**. An AC adapter is required when using the PG-FP5, so be sure to purchase an AC adapter.

1.7 AC Adapters for PG-FP5

The specifications of the AC adapter for the PG-FP5 differ depending on the region where the product is being used. Be sure to use the appropriate AC adapter for your region. Note that an AC adapter is not included with the PG-FP5. The appropriate AC adapter must be purchased separately.

Table 1-2. AC Adapters for PG-FP5 Used in Each Region

Name	Region ^{Notes 1, 2}	Part Number ^{Note 3}
AC adapter (sold separately)	Japan	QB-COMMON-PW-JP
	USA	QB-COMMON-PW-EA
	China	QB-COMMON-PW-CN
	Hong Kong	QB-COMMON-PW-HK
	Korea	QB-COMMON-PW-KR
	Singapore	QB-COMMON-PW-SG
	Chinese Taipei	QB-COMMON-PW-TW

- Notes**
1. The AC adapter corresponding to the region from which the order was received will be shipped.
 2. For regions other than those listed above, please contact a Renesas Electronics sales representative or distributor.
 3. You can only order the AC adapter that can be used in your region.

<R> 1.8 HCUHEX Files

HCUHEX files are files that are required when ordering flash memory products whose flash memories are pre-written by Renesas Electronics. HCUHEX files are generated by the HEX Consolidation Utility (HCU), after which they must be verified on a flash memory programmer before being submitted. The PG-FP5 handles HCUHEX files as master data, and can therefore be used to check the written data and the option data settings. HCUHEX files are supported in part of the RL78, 78K0, 78K0R, V850. If they are supported, it is described in the user's manual of the target microcontroller (the SH, RX, and R8C do not support HCUHEX files). For details, see the functional descriptions in this manual. For more information about HCU, see the HCU user's manual or the manual of the target device. The following websites describe details about HCU.

- Websites

Japanese version: <http://japan.renesas.com/hcu>

English version: https://www5.renesas.com/micro/tool_reg/OdsListTool.do?code=640&lang=en

Figure 1-2. PG-FP5 Connection Diagram

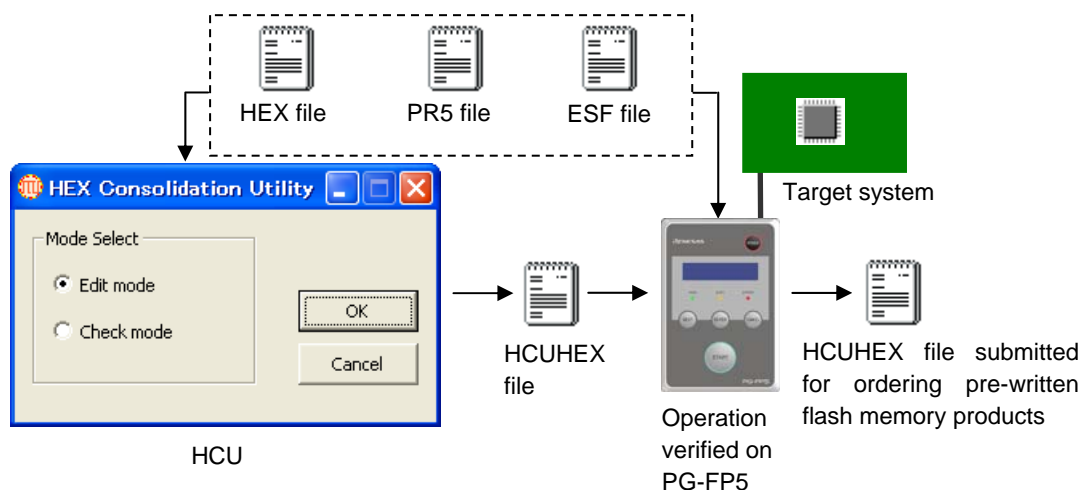

CHAPTER 2 HARDWARE CONFIGURATION

This chapter explains the following items for hardware configuration.

- Package contents
- System configuration
- Names and functions on main unit

2.1 Package Contents

Please verify that you have received all the parts listed in the package contents list included with the FP5 package. If any part is missing or seems to be damaged, please contact a Renesas Electronics sales representative or distributor.

2.2 System Configuration

The FP5 system configuration is as shown in the diagram below.

Figure 2-1. FP5 System Configuration

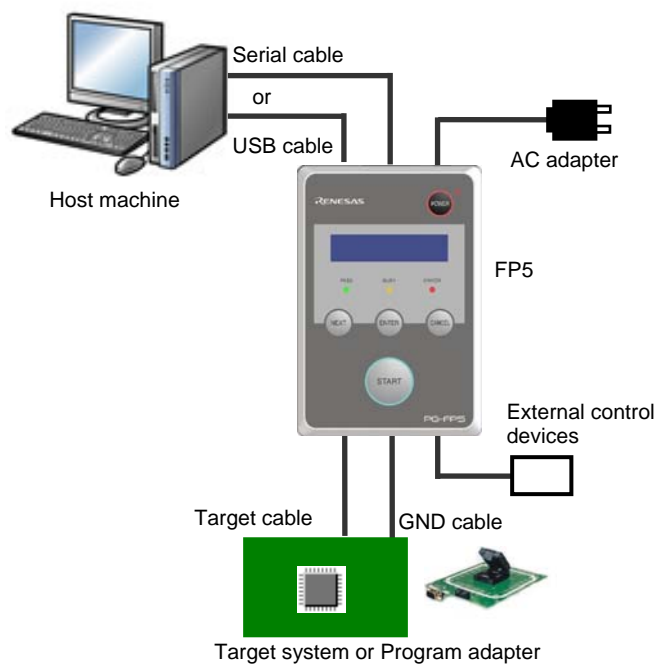

- Notes**
1. The target system and program adapter are not included in the FP5 package.
 2. The program adapter is a product of Naito Densai Machida Mfg. Co., Ltd.

The FP5 is connected to the host machine via a serial cable or a USB cable. The FP5 is connected to the target system via a target cable and a GND cable. And the FP5 can be remote controlled by connecting the remote connector and external control device.

2.2.1 Host machine

<R> A host machine is used to communicate with the FP5. The host machine must also be equipped with a serial port or a USB port.

2.2.2 Serial cable

Communication is established by using a serial cable to connect the host machine serial port and FP5 serial connector (RS-232C cross cable) connection. For details on the serial cable specifications, refer to **CHAPTER 9 CONNECTORS AND CABLES**.

2.2.3 USB cable

Communication is established by connecting the host machine USB port and the FP5 USB connector (mini-B type) using a USB cable. For details on the USB cable specifications, refer to **CHAPTER 9 CONNECTORS AND CABLES**.

2.2.4 AC adapter

Connect the FP5 power supply connector to the AC adapter included with the FP5. The AC adapter differs depending on the region where the product is being used. For details, see **Table 1-2 AC Adapters for PG-FP5 Used in Each Region**. An AC adapter is required when using the PG-FP5, so be sure to purchase an AC adapter.

2.2.5 Target cable

<R> A 16-pin connector or 14-pin connector is equipped on the tip of the target cable, which is connected to the target system or the program adapter. For details on the target cable specifications, refer to **CHAPTER 9 CONNECTORS AND CABLES**.

2.2.6 GND cable

To reinforce the GND, use a GND cable to connect the FP5 GND connector and the signal GND of the target system or program adapter. For details on the GND cable specifications, refer to **CHAPTER 9 CONNECTORS AND CABLES**.

Caution The FP5 and target system may be damaged if the voltage between the FP5 GND and the target system GND is different. Use the GND cable to match the voltage before connecting the target cable.

2.2.7 Target system

The target system must be equipped with a device interface that complies with the target cable specifications. For details on the specifications, refer to **CHAPTER 9 CONNECTORS AND CABLES**, **CHAPTER 10 NOTES ON TARGET SYSTEM DESIGN**, and **CHAPTER 11 SPECIFICATIONS OF TARGET INTERFACE CIRCUITS**.

2.2.8 Program adapter

The FP5 supports off-board programming through which programs are written via a program adapter (FA series) without mounting the target device onto the target system. Program adapters corresponding to each type of the target device package are available.

2.3 Names and Functions on Main Unit

This section describes the names and functions on the FP5 main unit.

2.3.1 FP5 control panel

Indicators and buttons are laid out on the FP5 top.

Figure 2-2. FP5 Top View <Control Panel>

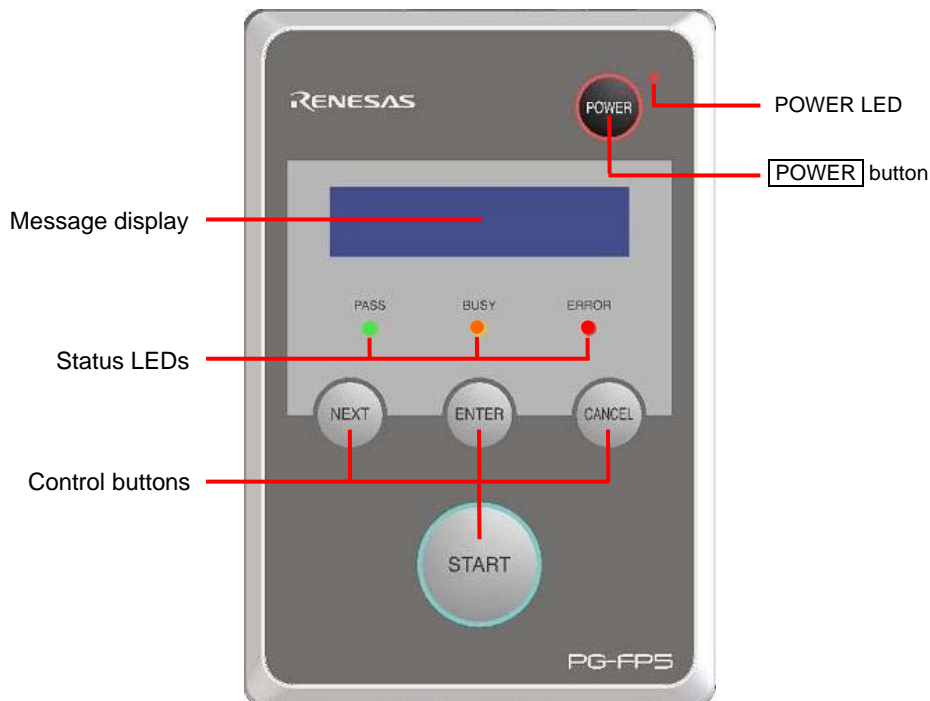

(1) Indicators

- **POWER LED** LED that displays the FP5 power status.
A red LED is turned on when the FP5 is ON, and is turned off when the FP5 is OFF.
- **Message display** An LCD display of 16 × 2-characters that indicates the operating mode or menus.
It is mainly used when the FP5 operates in standalone mode.
- **Status LEDs** LEDs that show the FP5 operating status.
PASS (green LED turned on) indicates normal completion, BUSY (orange LED flashes) indicates processing in progress, and ERROR (red LED turned on) indicates abnormal completion.

(2) Buttons

- **POWER** button Used to turn on/off the power to the FP5. Press this button longer (for about 1 minute) when turning on/off.
- **NEXT** button Proceeds to the next menu item at the same level in sequence.
- **ENTER** button Selects the item shown in the message display.
- **CANCEL** button Cancels the current selection and returns to the previous menu item. The command currently running cannot be stopped, except for the [Read] command.
- **START** button Executes the [Autoprocedure(E.P.)] command with a valid programming area setting.

Remark The **NEXT**, **ENTER**, **CANCEL** and **START** buttons are mainly used in standalone mode. When the FP5 Manager is used to switch to the bank mode or simple mode, the button functions and message display functions will change. Refer to **4.3.2 (9) [FP5 Manager] Command** and **CHAPTER 7 USAGE THE REMOTE CONNECTOR**.

2.3.2 FP5 connectors

The power supply connector, serial connector and USB connector are laid out on the host interface side.

The target connector, GND connector and remote connector are laid out on the target connector side.

When the FP5 Manager is used to switch to the bank mode or simple mode, the button functions and message display functions will change. Refer to **4.3.2 (9) [FP5 Manager] Command** and **CHAPTER 7 USAGE THE REMOTE CONNECTOR**.

Figure 2-3. FP5 Top View <Connector>



Figure 2-4. FP5 Host Interface Side

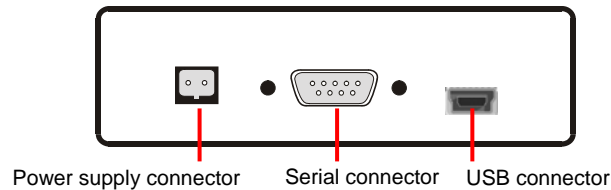
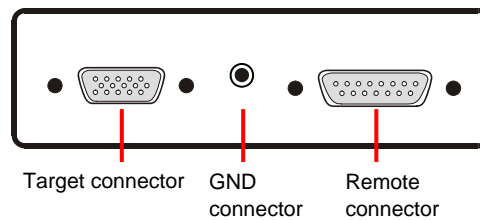

Figure 2-5. FP5 Target Connector Side

**(1) Power supply connector**

Connect the power supply connector to the AC adapter included with the FP5. For details on the power supply connector specifications, refer to **CHAPTER 9 CONNECTORS AND CABLES**.

<R>

Caution Do not use an AC adapter other than that included with the PG-FP5.

(2) Serial connector

Communication is established by using a serial cable (RS-232C cross cable) connection to connect the host machine serial port and FP5 serial connector. The data transfer conditions are as follows.

- Data transfer speed: 9,600 bps, 19,200 bps, 38,400 bps, 57,600 bps, or 115,200 bps
- Data bit: 8 bits
- Parity: none
- Stop bit: 1 bit
- Flow control: hardware

The transfer speed is set to 9,600 bps by default, but it can be changed. For details on the serial connector specifications, refer to **CHAPTER 9 CONNECTORS AND CABLES**.

(3) USB connector

Communication is established by using a USB cable to connect the host machine USB port and the FP5 USB connector (mini-B type). This connector conforms with USB 2.0 standards. For details on the USB connector specifications, refer to **CHAPTER 9 CONNECTORS AND CABLES**.

(4) Target connector

Connect the target connector to the target system using the target cable for on-board programming. Connect the target connector to the program adapter using the target cable for off-board programming. For details on the target connector specifications, refer to **CHAPTER 9 CONNECTORS AND CABLES**.

(5) GND connector

To reinforce the GND, connect the FP5 GND connector and the signal GND of the target system or program adapter using a GND cable. For details on the GND connector specifications, refer to **CHAPTER 9 CONNECTORS AND CABLES**.

Caution The FP5 and target system may be damaged if the voltage between the FP5 GND and the target system GND is different. Use the GND cable to match the voltage before connecting the target cable.

(6) Remote connector

The FP5 can be remote controlled by connecting the remote connector and external control device. For details on the Remote operation, refer to **CHAPTER 7 USAGE THE REMOTE CONNECTOR, CHAPTER 9 CONNECTORS AND CABLES**.

CHAPTER 3 SOFTWARE INSTALLATION

This chapter explains the following items related to installation.

- Obtaining software
- Installation
- Uninstallation
- Updating programming GUI, firmware and FPGA

<R> 3.1 Obtaining Software

Download the programming GUI, USB driver, and FP5 parameter file (PR5 file) from the following Renesas Electronics website.

- URLs Japanese version: http://japan.renesas.com/pg_fp5
 English version (Except for Europe area): http://www.renesas.com/pg_fp5
 English version (For Europe area): <http://www.renesas.eu/update> → Section PG-FP5-EE

Caution Use of the latest version of software is recommended to assure the FP5 operation.

3.2 Installation

This section explains the installation procedure for the programming GUI, USB driver and parameter file (PR5 file).

<R> **Table 3-1. Installation**

Installation Order	Item	Method
1	Programming GUI, USB driver	Run the downloaded executable file (PG-FP5_Package_Vxxx.exe) and perform installation, following the directions on the installer screen. After installation, the USB driver detects the FP5 by plug-and-play, and it is automatically added.
2	PR5 file	Decompress the downloaded file to any folder. A *.pr5 file is decompressed into any folder, so copy it to the FP5_PRJ folder where the programming GUI is installed.

The folder configuration after programming GUI installation is as follows.

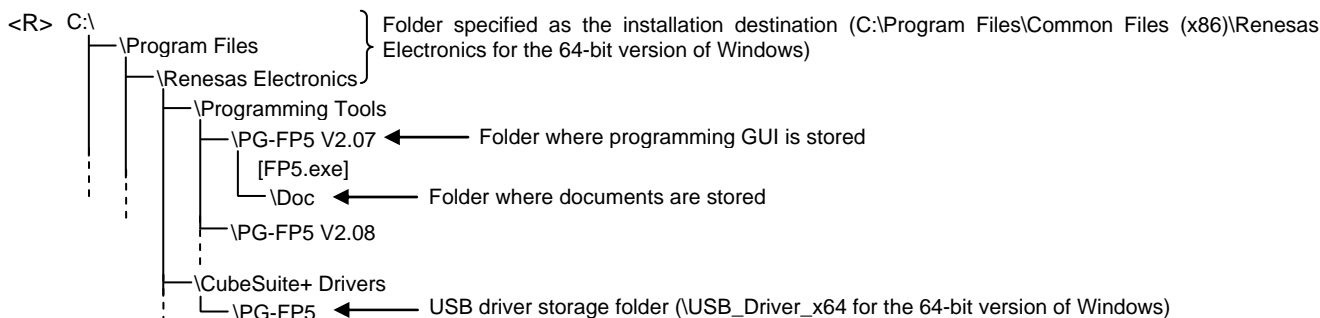

3.2.1 Notes on installation

- (1) Multiple versions of the PG-FP5 can be installed on a single host machine. Although we recommend using the latest version of any development tool, leaving a previous version on your host machine and then installing the latest version lets you easily switch the development environment.
- (2) You might be asked to reboot your computer after installing the PG-FP5. Be sure to close all other applications before rebooting your computer.
- (3) You must have administrator privileges to install the PG-FP5.
- (4) The PG-FP5 can only be installed in a folder that is named using ASCII characters. (Note that the 11 characters / * : < > ? | " \ ; , and character strings that begin and end with a space cannot be used.) The PG-FP5 might not operate correctly if installed in a folder that is named using other characters.
- (5) The PG-FP5 cannot be installed from a network drive or on a network drive.
- (6) The installer does not specify environment variable paths. If these paths are required, add them after installation.
- <R> (7) The help feature was created using HTML Help files. If the help feature is not operating correctly, make sure you are using Microsoft Internet Explorer 6.0 or later.
- <R> (8) For the programming GUI installer, the .NET Framework 3.5 SP1 and Visual C++ 2008 SP1 runtime library must be installed in advance. If they are not installed yet, install them in advance.
 - Installing NET Framework (not required for Windows 7)
Microsoft .NET Framework 3.5 Service Pack 1
<http://www.microsoft.com/downloads/en/details.aspx?displaylang=en&FamilyId=AB99342F-5D1A-413D-8319-81DA479AB0D7>
 - Installing Visual C++ 2008 SP1 Redistributable Package (x86)
Microsoft Visual C++ 2008 SP1 Redistributable Package (x86)
<http://www.microsoft.com/downloads/en/details.aspx?FamilyID=A5C84275-3B97-4AB7-A40D-3802B2AF5FC2>

* If multibyte characters are contained in Windows temporary file names, an error may occur during installation (e.g. the login name is in Japanese).
- <R> (9) The following folders created after installation (including the files under the folders) contain files required for the tools to operate. Do not delete them.
(Windows is the 32-bit edition and the system drive is C:)
C:\Program Files\Common Files\Renesas Electronics CubeSuite+\n
(Windows is the 64-bit edition and the system drive is C:)
C:\Program Files\Common Files (x86)\Renesas Electronics CubeSuite+\n
- <R> (10) To change the folder of the installed tools, uninstall all the CubeSuite+ related software and the programming GUI for PG-FP5, and install them again.
- <R> (11) In the environment where the programming GUI for CubeSuite+ and PG-FP5 and USB driver for PG-FP5 are installed, the programming GUI for PG-FP5 and USB driver for PG-FP5 are included in the target software of the CubeSuite+ integrated uninstaller. If you don't want to delete them, remove them from the uninstallation targets.

<R> 3.3 Uninstallation

This section explains how to uninstall the programming GUI, USB driver, parameter file (PR5 file), customized setup file (ESF file) and setting information file (INI file). The uninstallation order is prescribed.

Table 3-2. Uninstallation

Item	Method
Programming GUI, USB driver	Open [Add or Remove Programs] (or [Add/ Remove Programs]) on the Control Panel and uninstall this program. The names are [PG-FP5 Vx.xx] and [USB Driver x86 for PG-FP5] (or [CubeSuite+ USB Driver x64 for Renesas MCU Tools]). Parameter files (*.pr5), setting files (*.esf), and INI file (FP5.ini) are not deleted.
PR5 file	Delete PR5 files (*.pr5) stored in the FP5_PRJ folder in the programming GUI installation folder.
ESF file	Delete ESF files (*.esf) stored in the FP5_PRJ folder in the programming GUI installation folder, or other folder.
INI file	Delete INI files (FP5.ini) stored in the WINDOWS folder. Storage location in Windows XP C:\Windows Storage location in Windows Vista/Windows 7 C:\Users\User Name\AppData\Local\VirtualStore\Windows

3.4 Updating Programming GUI, Firmware and FPGA

The firmware and FPGA are programs embedded in the device for controlling the FP5. Updating the programming GUI, firmware and FPGA enables the following.

- Addition of newly supported functions or devices
- Correction of restrictions

Use of the latest versions of the programming GUI, firmware and FPGA are recommended to assure the FP5 operation.

The latest versions are available on the following websites.

- <R> URLs Japanese version: http://japan.renesas.com/pg_fp5
 <R> English version (Except for Europe area): http://www.renesas.com/pg_fp5
 English version (For Europe area): <http://www.renesas.eu/update> → Section PG-FP5-EE

Caution If update of firmware and FPGA is improperly performed, FP5 may no longer operate. Refer to the following procedure or method for updating.

Remark If the firmware or FPGA is updated, the PR5 file, ESF file or program file may be deleted. In such cases, download the PR5 file, ESF file or program file again.

Be sure to follow the procedure below when updating the firmware and FPGA.

- Step 1. Check the current version. (Refer to **3.4.1 Checking the current version.**)
- Step 2. If not the latest version, update the programming GUI. (Refer to **3.4.2 Installation of programming GUI.**)
- Step 3. Update the firmware using the latest programming GUI. (Refer to **3.4.3 Installation of firmware update.**)
- Step 4. Update the FPGA using the programming GUI. (Refer to **3.4.4 Installation of FPGA update.**)

3.4.1 Checking the current version

- (1) Open the main window of the programming GUI. (Refer to **4.1 Introduction**.)
- (2) Check the versions of the programming GUI, firmware and FPGA, as shown below.

Programming GUI: [Help] menu → [About]

Firmware: [Programmer] menu → [Reset] command^{Note}

FPGA: [Programmer] menu → [Reset] command^{Note}

Note Display example of [Reset] command

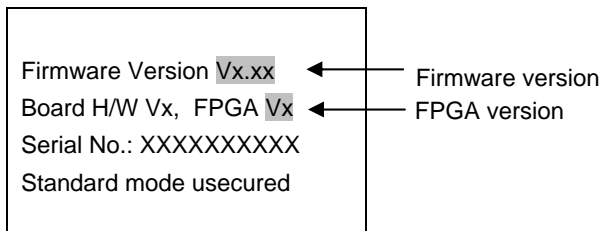

- (3) The latest versions are available on the following websites.

<R> URLs Japanese version: http://japan.renesas.com/pg_fp5

<R> English version (Except for Europe area): http://www.renesas.com/pg_fp5

English version (For Europe area): <http://www.renesas.eu/update> → Section PG-FP5-EE

3.4.2 Installation of programming GUI

<R> Run the downloaded executable file (PG-FP5_Package_Vxxx.exe). Perform installation, following the directions on the installer screen.

3.4.3 Installation of firmware update

Install the latest firmware by using the latest programming GUI. Decompress the file to any folder. The firmware file “fp5_fw_vxxx.rec” will be decompressed to the selected folder. (“xxx” indicates the firmware version.)

- (1) Click the [Programmer] menu on the menu bar and select [Update Firmware]; the [Update Firmware] dialog box will then be opened.

<R>

Figure 3-1. [Update Firmware] Command

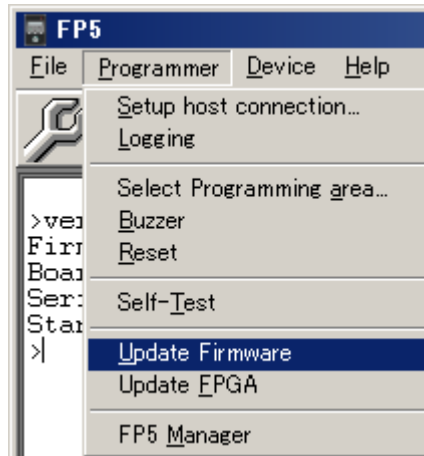
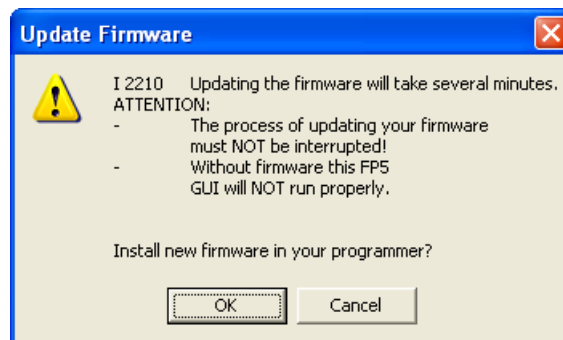
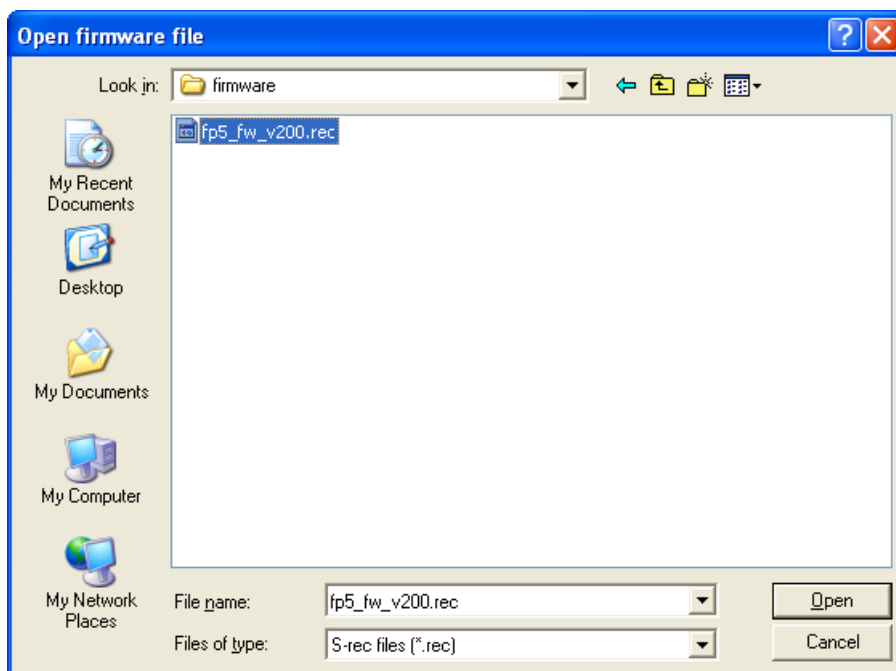

Figure 3-2. [Update Firmware] Dialog Box



- (2) Click the **OK** button to continue firmware update. The [Open firmware file] dialog box is opened.

Figure 3-3. [Open firmware file] Dialog Box



Select the firmware file "fp5_fw_vxxx.rec" and then click the **Open** button.

- Cautions**
- 1. Do not use FP5 firmware other than the one posted on the website; otherwise, a defect may occur.**
 - 2. When a firmware of FP5 updates from V2.00 to V1.xx, a serial number of FP5 is erased. And, FP5 can't operate in USB1.1. In addition, the other functions don't have any problem. When FP5 revives, consult a Renesas Electronics sales representative or distributor.**

- (3) Some commands are sent to the FP5 and the update progress status is displayed in the action log window. The message "Firmware Update succeeds", which indicates normal completion of firmware update, and "Restarting FP5..", which is equivalent to [RESET] command processing, is automatically performed. The new version can then be checked as "Firmware Version Vx.xx". The update takes about 10 seconds.

Remark The action log window is a part of the main window of the programming GUI, which shows the operation progress status.

<R>

Figure 3-4. Action Log Window When Firmware Update Is Finished

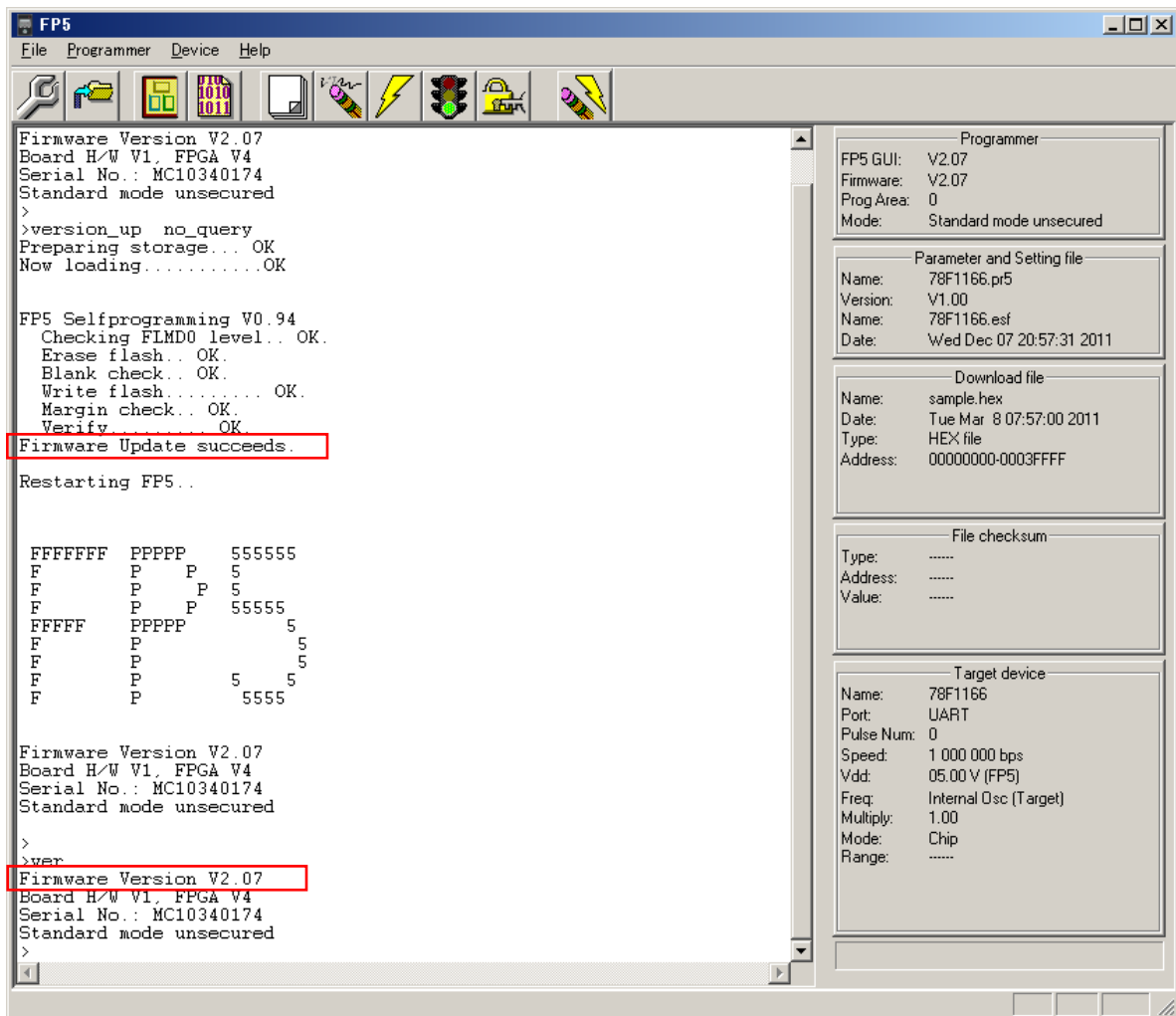

Remark Depending on the changes made, the following dialog box will be displayed. In this case, the information stored in the FP5 (PR5 file, ESF file, program file) will have been deleted, so please download those files again. (Refer to 4.2 Starting the Programming GUI.)

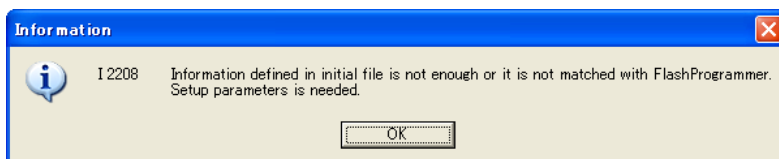

3.4.4 Installation of FPGA update

Install the latest FPGA by using the latest programming GUI. Decompress the file to any folder. The FPGA file “fp5_fpga_vx.rec” will then be decompressed into the folder, so copy it to any folder. (“x” indicates the FPGA version.)

- (1) Click the [Programmer] menu on the menu bar and select [Update FPGA]; the [Update FPGA] dialog box will then be opened.

<R>

Figure 3-5. [Update FPGA] Command

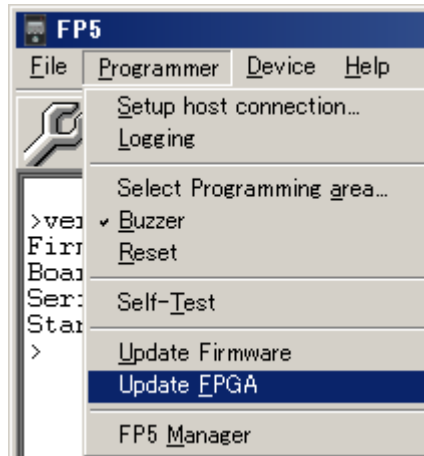
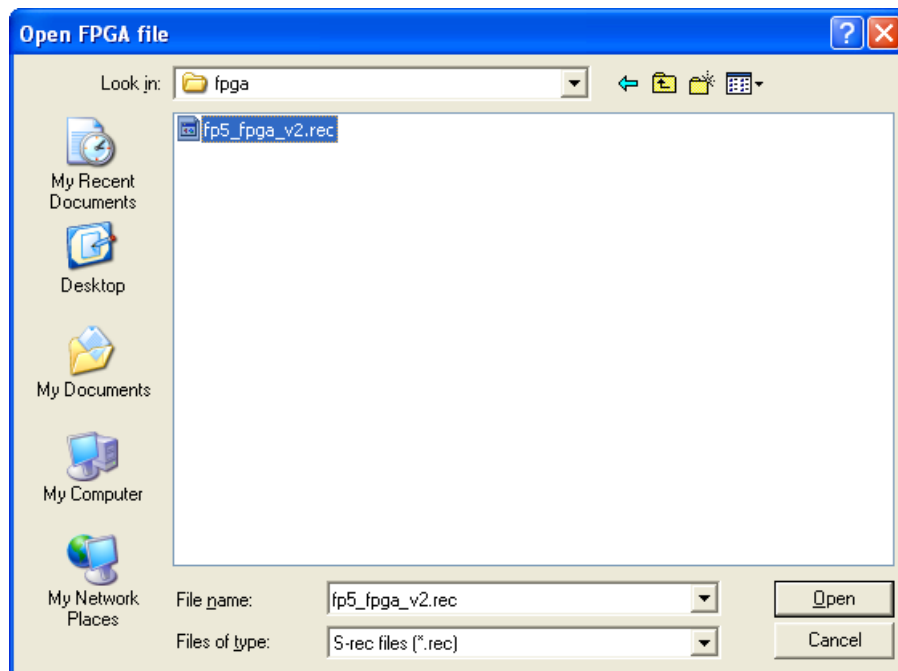

Figure 3-6. [Update FPGA] Dialog Box



(2) Click the **OK** button to continue FPGA update. The [Open FPGA file] dialog box is opened.

Figure 3-7. [Open FPGA file] Dialog Box



Select the FPGA file "fp5_fpga_vx.rec" and then click the **Open** button.

Caution Do not use an FP5 FPGA other than the one posted on the website; otherwise, a defect may occur.

- (3) Some commands are sent to the FP5 and the update progress status is displayed in the action log window. The message “FPGA Update succeeded”, which indicates normal completion of firmware update, and “FP5 Power will be switched OFF now.....”, which is equivalent to processing when the **POWER** button is turned off, is automatically executed. The update takes about 30 seconds.

<R>

Figure 3-8. Action Log Window When FPGA Update Is Finished

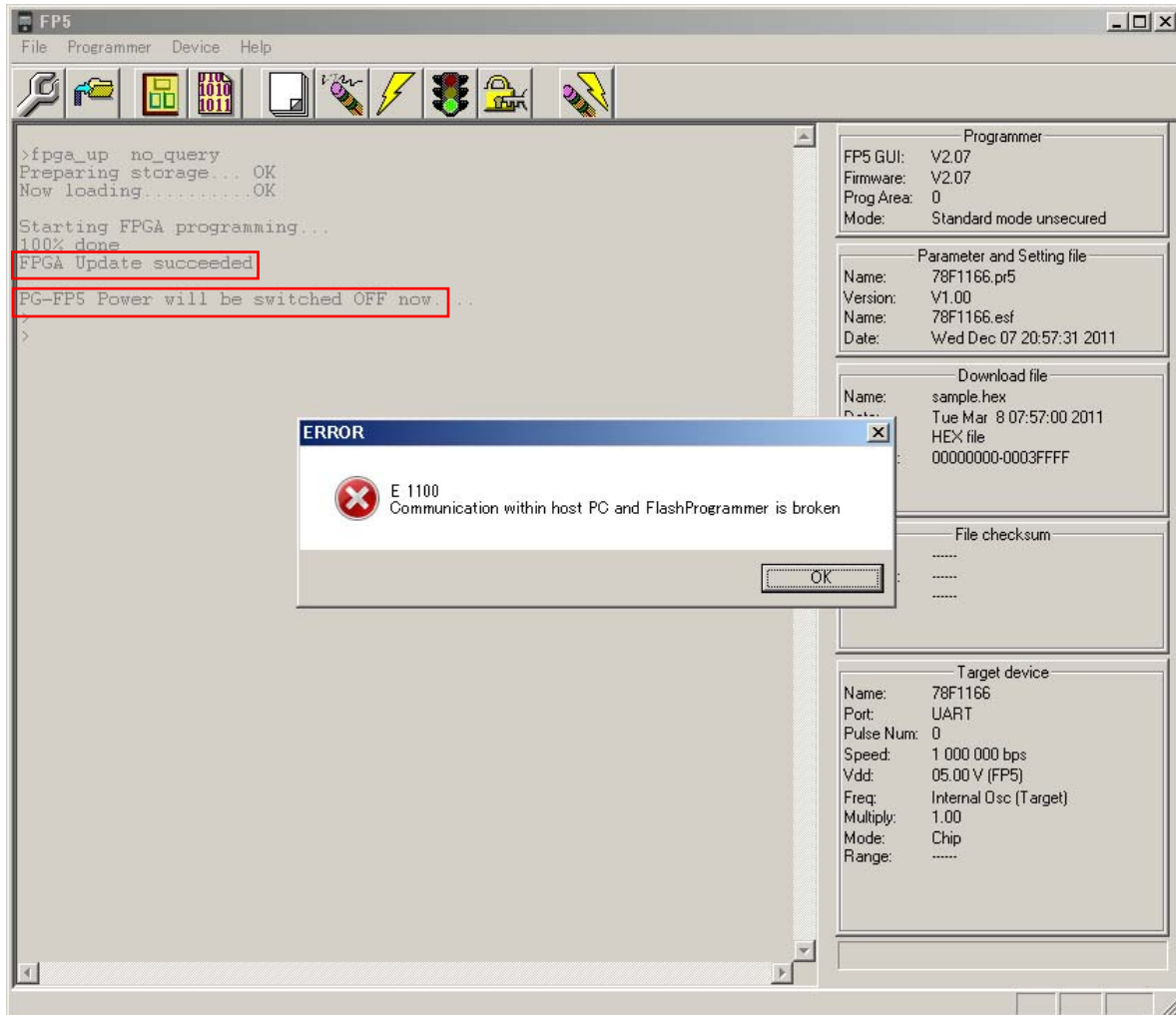

- (4) Click the **OK** button in the error message dialog box and then press the **POWER** button on the FP5 to turn on power.

- (5) Click the [Programmer] menu on the menu bar and select [Setup host connection...]; the [Host Connection] dialog box will then be opened. Select the communication mode used and then click the [OK] button.

<R>

Figure 3-9. [Setup host connection] Command

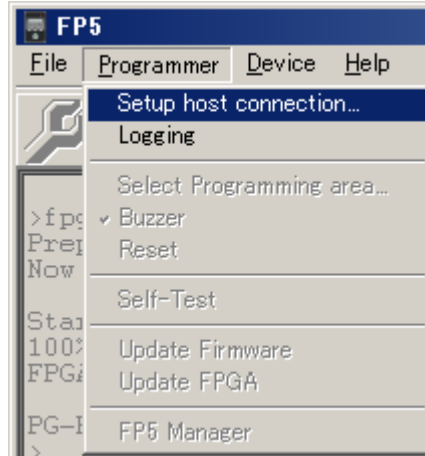
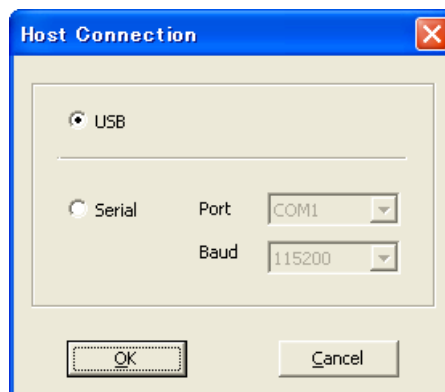

Figure 3-10. [Host Connection] Dialog Box



- (6) Communication with the host machine is established. "FPGA Vx" is displayed in the action log window; thus, the version can be checked.

<R>

Figure 3-11. Version Confirmation After FPGA Update Is Finished

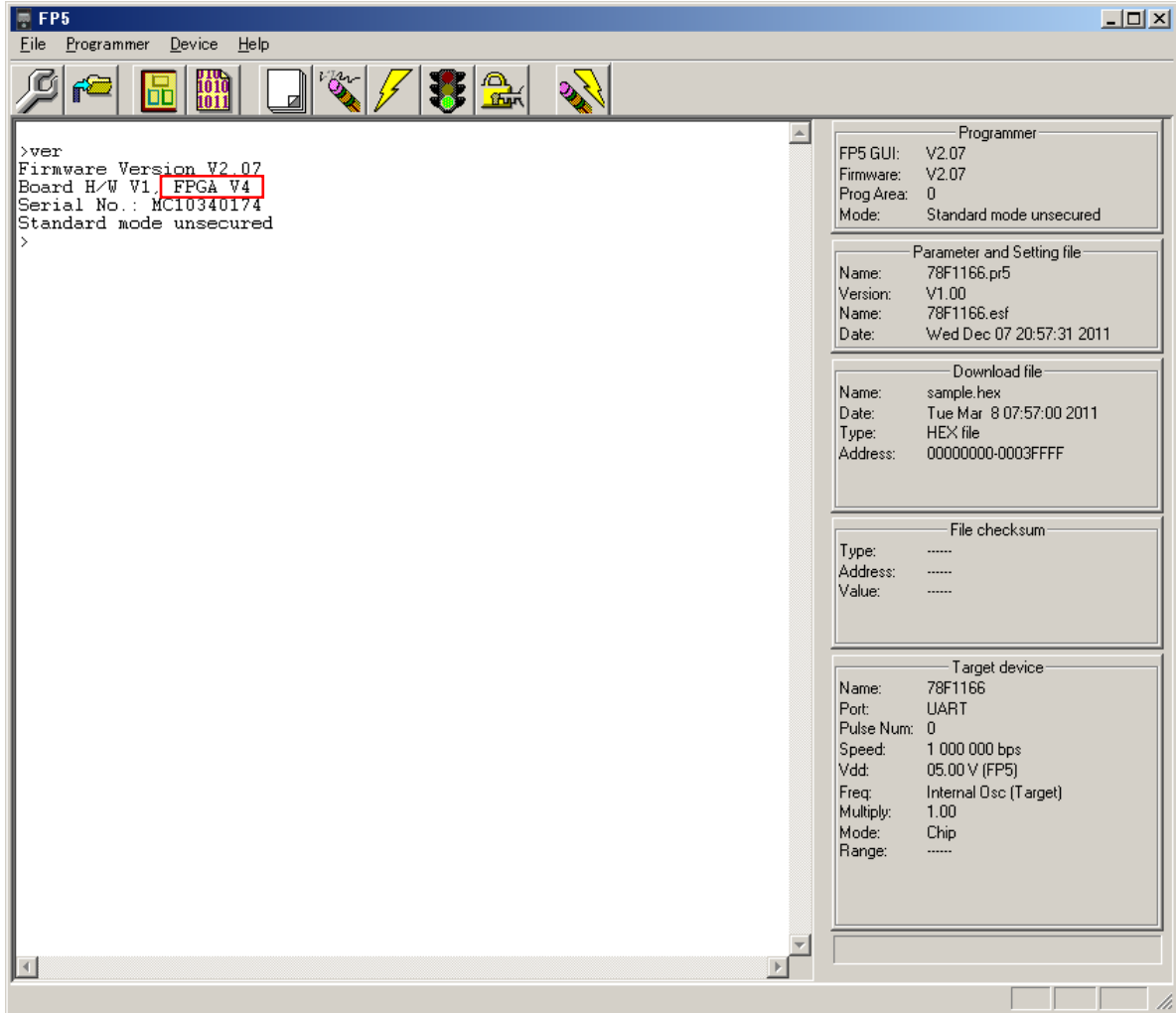

CHAPTER 4 PROGRAMMING GUI USAGE

This chapter explains functional details on windows and dialog boxes of the programming GUI.

4.1 Introduction

Make sure that the programming GUI, USB driver, and the FP5 parameter file (PR5 file) for the target device are installed. For the installation method, refer to **CHAPTER 3 SOFTWARE INSTALLATION**.

4.2 Startup of Programming GUI

(1) System connection

Connect a USB cable (or serial cable) to the USB port (or serial port) on the host machine, and the other side of the cable to the USB connector (or serial connector) on the FP5. Plug in the AC adapter and then connect to the FP5 power supply connector.

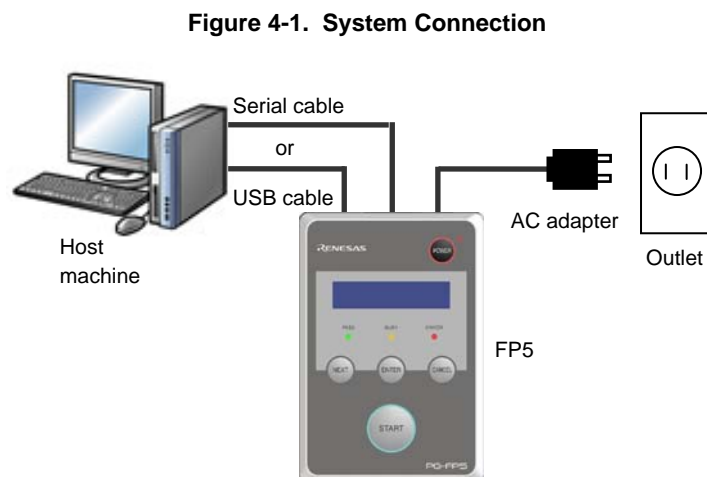

(2) FP5 startup

After the cables are connected, press the **POWER** button on the FP5. When the FP5 is correctly started, the POWER LED is turned on and "Commands >" is displayed in the message display. If not, the cause may be a defect in the FP5, so consult a Renesas Electronics sales representative or distributor.

(3) Startup of programming GUI

<R> Click the Start menu, “All Programs”, point to “Renesas Electronics CubeSuite+”, “Programming Tools”, and then select “PG-FP5 Vx.xx” of “PG-FP5 Vx.xx” to start the Programming GUI. The valid communication mode is automatically detected in the order of the USB, and then the serial interface.

Figure 4-2. Port Scanning at Startup of Programming GUI

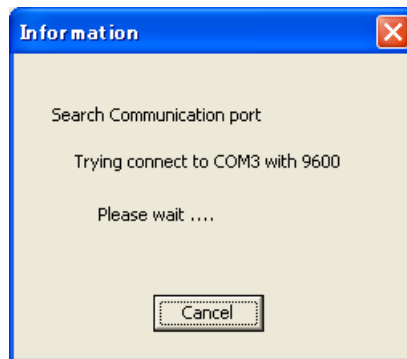

The communication mode can also be selected by cancelling this operation by clicking the **Cancel** button and selecting the [Setup host connection...] command in the **[P]rogrammer** menu.

When communication is established and the programming GUI is correctly started, the main window will be opened. Note that when the programming GUI is started for the first time, the valid programming area is cleared or once FP5 unit from a number of units has been connected, the following message will be displayed, so download the following ESF file, PR5 file or program file. This message means that ESF file and program file in the FP5 unit and the information stored in the programming GUI (INI file) do not match.

Figure 4-3. Message Displayed at the First Startup of Programming GUI

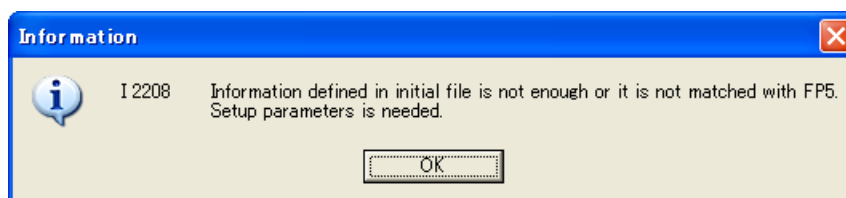

- Step 1. Click the **OK** button in the dialog box.
- Step 2. The following dialog box will be displayed. Click **Yes** or **No**.

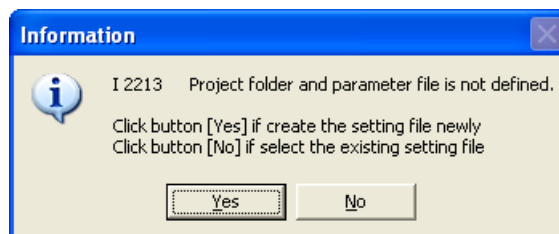

Step 3. Clicking **Yes** will open a dialog box to make a new ESF file. Refer to 4.3.3 (15) (a) <3> **New...** Button for the steps that follow.

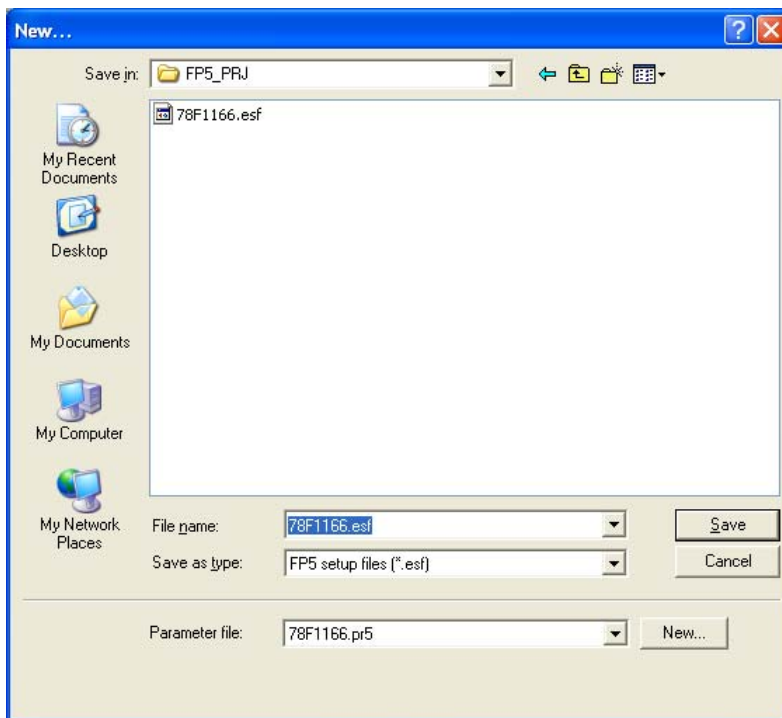

Clicking **No** will open a dialog box to select a previously created ESF file. Refer to 4.3.3 (15) (a) <3> **...** Button for the steps that follow.

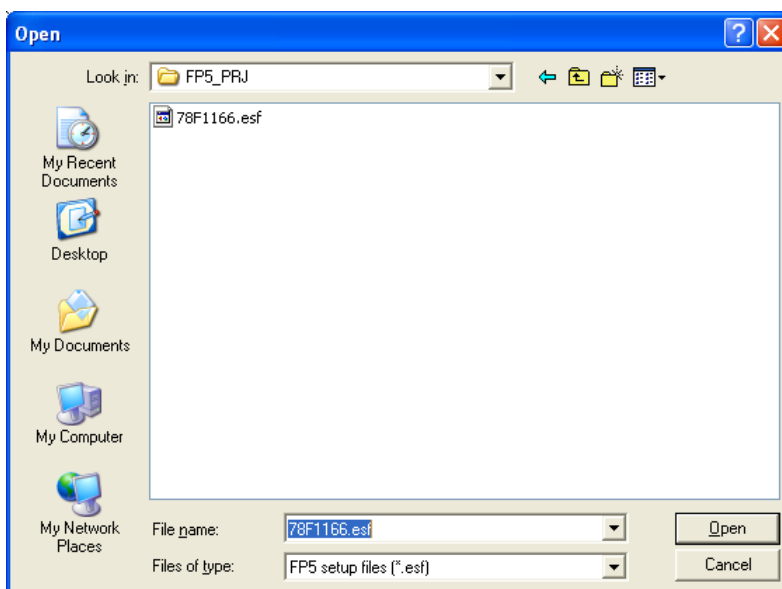

Step 4. Next, the device setup dialog box that is opened when [Device] menu -> [Setup...] command is executed will be opened, so make the settings. Refer to 4.3.3 (15) [Setup...] command for the steps that follow.

Figure 4-4. Main Window

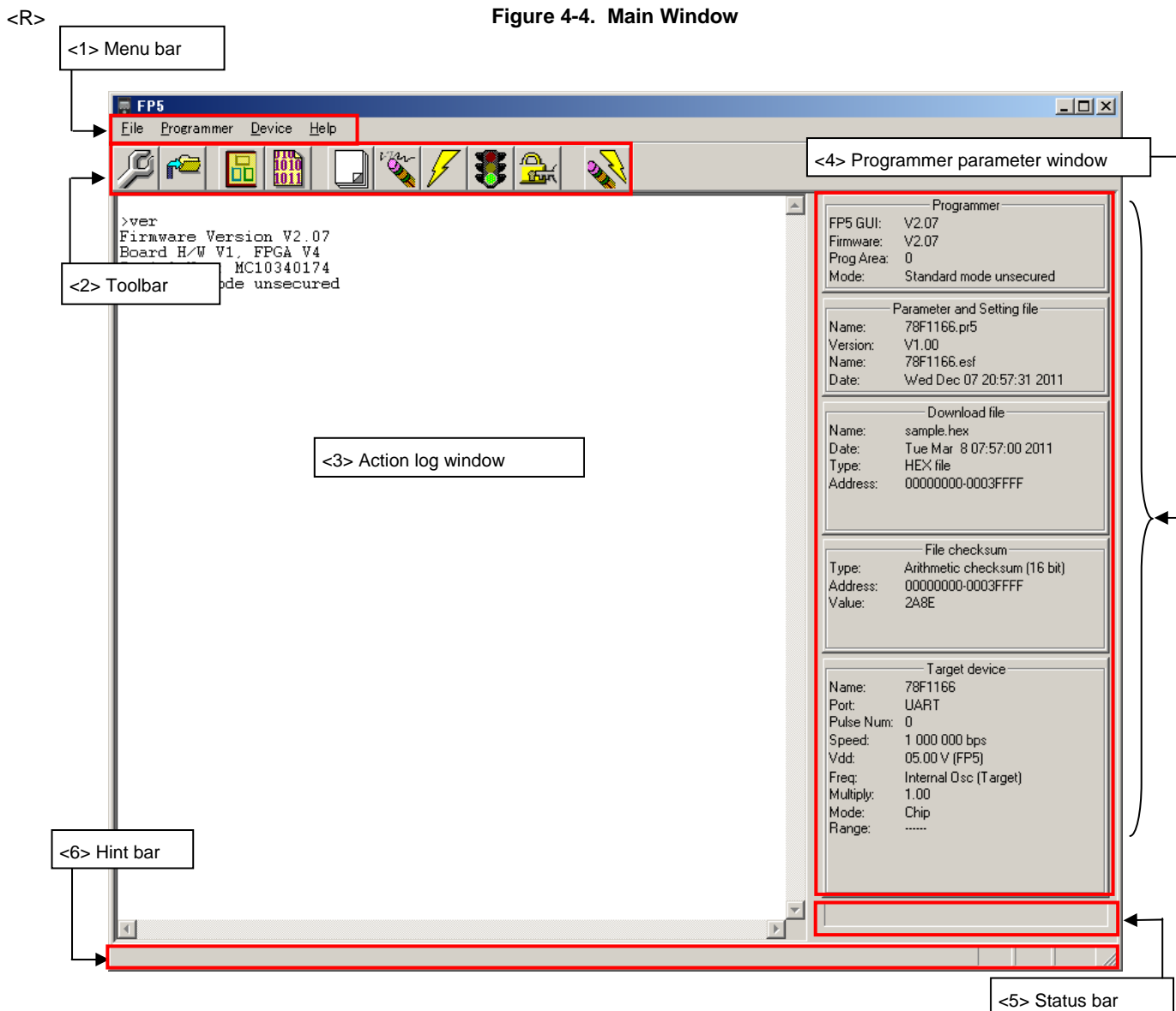

The main window consists of the following areas.

	Name	Displayed Items	Refer to:
<1>	Menu bar	Menu items executable by the programming GUI	4.3
<2>	Toolbar	Frequently used commands, as buttons	4.4
<3>	Action log window	A programming GUI action log	4.5
<4>	Programming parameter window	Programming parameter settings	4.6
<5>	Status bar	Command progress shown as a color or with a message	4.7
<6>	Hint bar	Hints for commands and toolbar	4.8

4.3 Menu Bar

The menu bar displays the commands that are available for the programming GUI. Some commands may be unavailable when the programming GUI is started for the first time, depending on the parameter file (PR5 file) selected or FP5 Manager setting. Also, if an HCUHEX file is selected, the HCUHEX file is handled as master data, so the [Program], [Read], [Set Security], [Set Option bytes], and [Set OCD Security ID] commands are unavailable.

Caution During command execution, do not execute other commands or terminate the programming GUI.

4.3.1 [File] menu

The following pull-down menu appears by clicking the [File] menu.

This menu includes commands related to program file operation.

<R>

Figure 4-5. [File] Menu

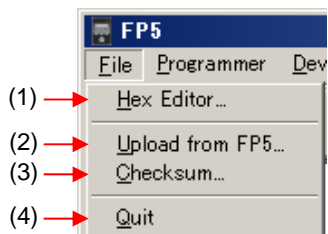

(1) [Hex Editor...] command

<R>

The [Hex Editor] menu allows you to edit a program file in Intel HEX format or Motorola HEX format. When this command is executed, a program file select dialog box is opened and the file to be edited can be specified. Note that HCUHEX files, DDI files, and program files for the RX family, R8C family, SuperH family cannot be loaded in this dialog box.

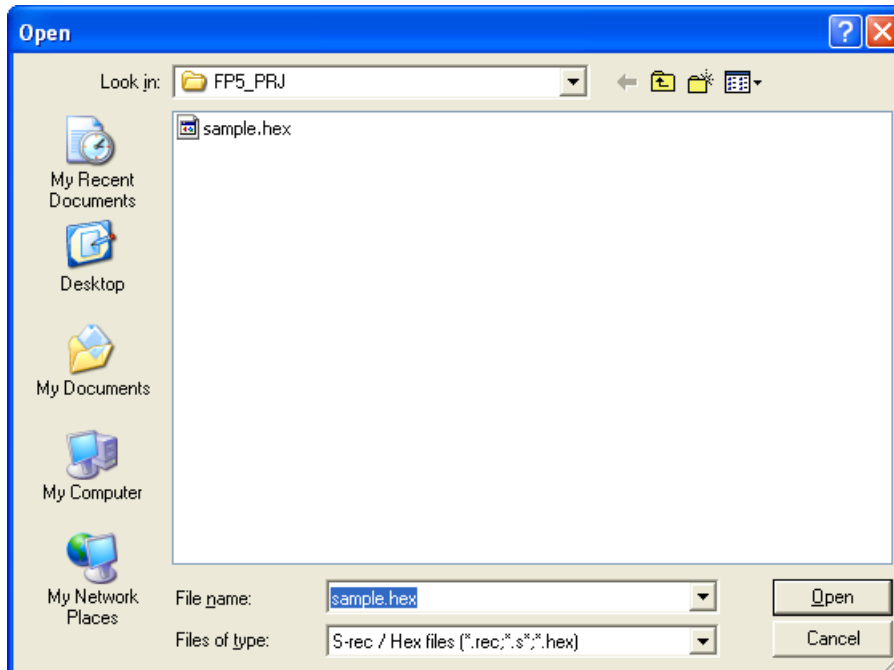
Figure 4-6. Program File Select Dialog Box

S-rec / Hex files (*.rec;*.s*;*.hex) or All files (*.*) may be selected from the Files of types list box.

After selecting a file to be opened, the file selected in the HEX Editor main window is loaded. At this time, whether the file is of the Intel HEX format or Motorola HEX format is automatically recognized. When loading is finished, the HEX Editor main window is opened.

Figure 4-7. HEX Editor Main Window

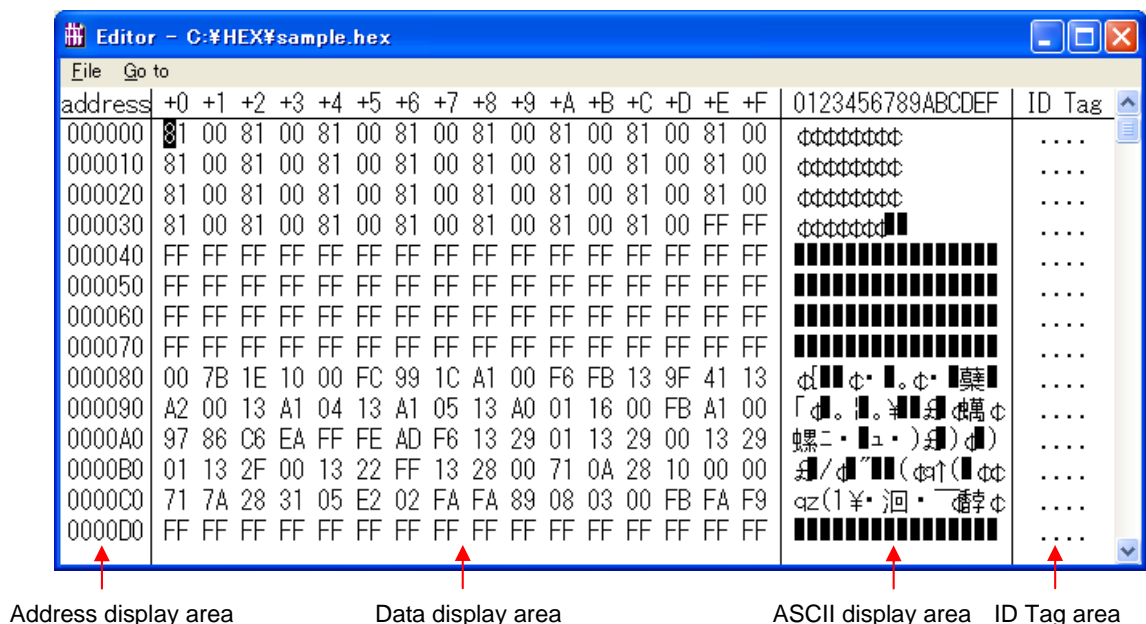

The displayed file contents can be modified by placing the pointer in the data display area in the HEX Editor main window. Data input via the keyboard is accepted for all shown memory locations.

The ID Tag area is the area used with the target device supporting data flash. Only area indicating 0 or 1 can be edited in this area. Input 0 or 1 for the ID Tag area. If 0 is input, then 00000000h will be set, and if 1 is input, FFFFFFFFh will be used as the ID Tag. For details on data flash and ID tags, refer to the user's manual of the target device.

The HEX Editor only accepts hexadecimal data, i.e., numbers 0 to 9 and letters A to F. All other data will be rejected.

The ASCII representation, if any, is shown in the ASCII display area. This area is for reference only, so no data can be input.

Use the scroll bar to move another address range into the visible area of the HEX Editor.

The following keys can be input using the keyboard.

Table 4-1. Key Functions That Can Be Input in HEX Editor Window

Key	Function
0-9, A-F	Data input (data display area)
→	Move cursor in right direction
←	Move cursor in left direction
↑	Move cursor in up direction
↓	Move cursor in down direction
Tab	Tab Move cursor to next input field (address + 1)

If any changes have been made to the file, [Save] and [Save As] in the [File] menu in the HEX Editor main window become available for saving the modified data.

The [Save As] display varies whether or not the downloaded PR5 file is for the target device that supports data flash.

Figure 4-8. [Save As] Dialog Box of HEX Editor

(a) The downloaded PR5 file is for a target device that does not support data flash

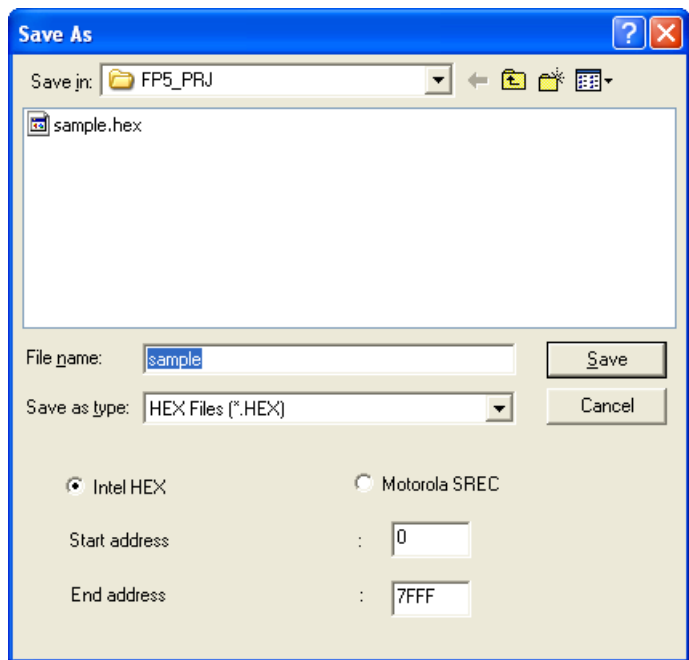

(b) The downloaded PR5 file is for a target device that supports data flash

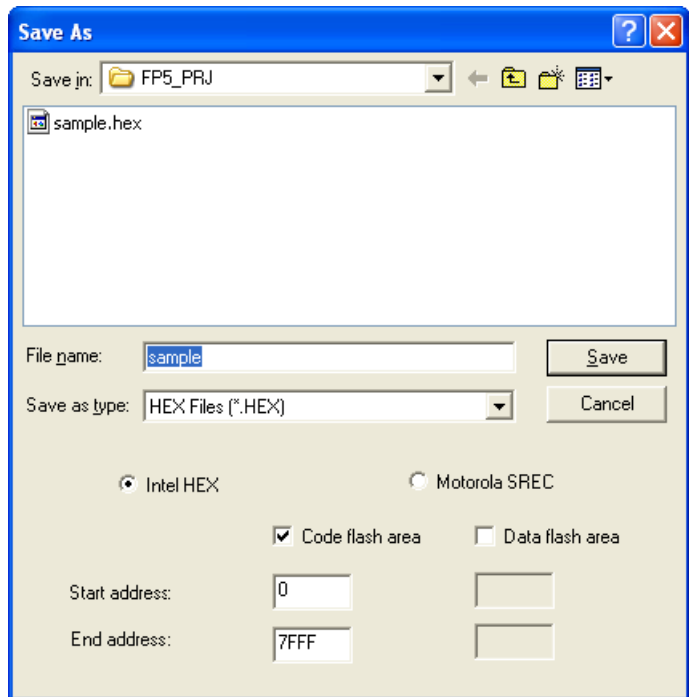

Besides the file name and folder location, a start address and an end address for the new file can be selected in the [Save As] dialog box. The original start address and end address are displayed by default. Select the file radio button for the format in which to save the data. Select the same format as that of the loaded file. Use of the saved file with other tool products is not supported.

<R> **Remark** In a microcontroller that supports ID Tags of data flash, for the saved program file contents of the data flash area, refer to **Figure B-1 Relationship Between HEX Editor and Saved Program File**.

(2) [Upload from FP5...] command

The [Upload from FP5...] command is used to upload the program file, PR5 file and ESF file saved in a valid programming area.

Figure 4-9. [Upload from FP5...] Dialog Box in the HEX Editor (1/2)

<R> (a) When a product without data flash is selected from the 78K, V850, RL78 family

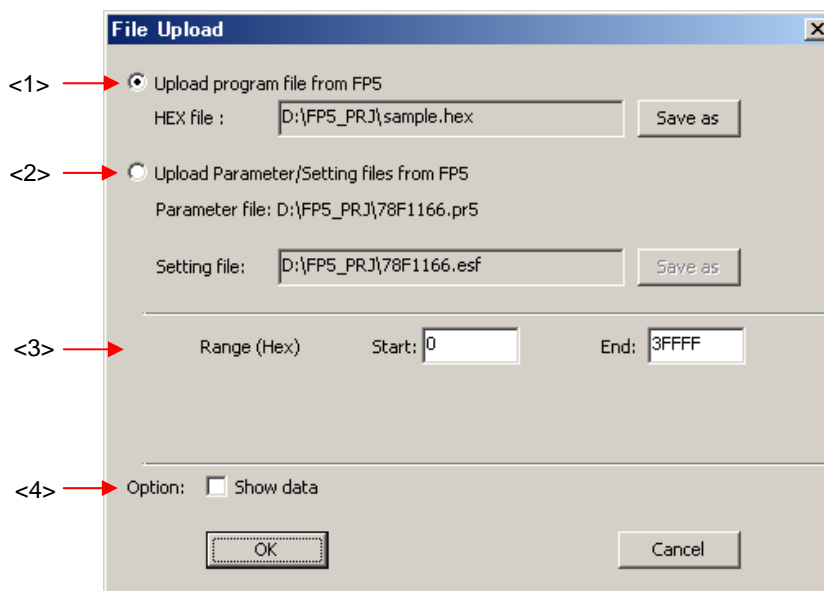
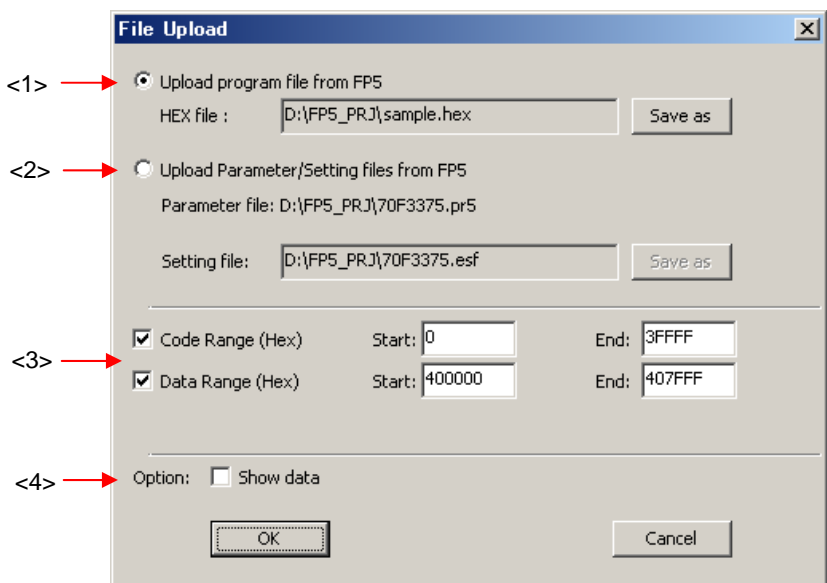
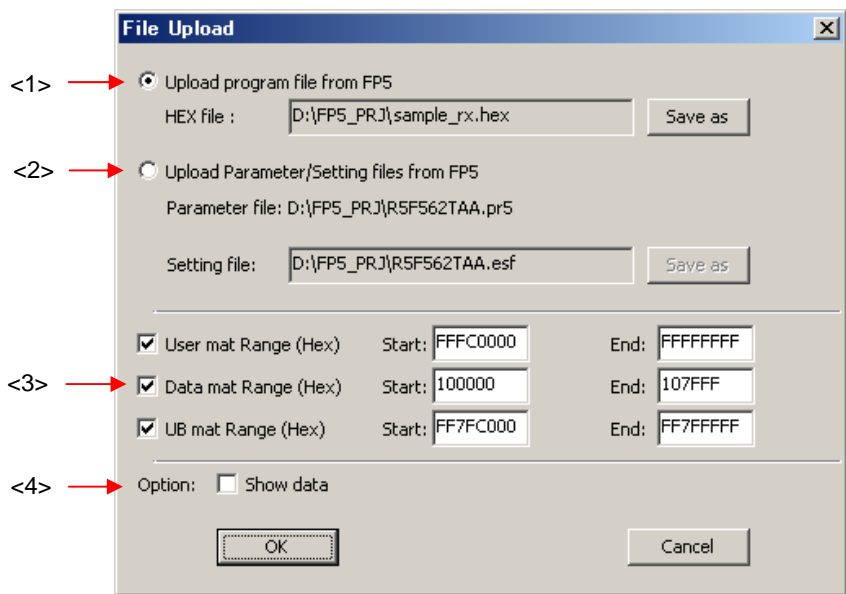

Figure 4-9. [Upload from FP5...] Dialog Box in the HEX Editor (2/2)

<R> (b) When a product with data flash is selected from the 78K, V850, RL78 family



<R> (c) When the RX family, R8C family, or SuperH family is selected



<1> [Upload program file from FP5] button

The storage location and file name of the program file are specified in the HEX file: box. In order to change the file location or name, click the **Save as** button and make the changes.

<2> [Upload Parameter/Setting files from FP5] button

The Parameter file: box specifies the storage location of the PR5 file. The Setting file: box specifies the ESF file storage location and file name. In order to change the file locations, click the **Save as** button and make the changes. The parameter file names cannot be changed.

<3> Address range selection area

<R> This area is enabled with the [Upload program file from FP5] button clicked. Specify the address range of the program file that is to be saved. When a product with data flash is selected from the 78K, V850, RL78 family, [Code flash:] and [Data flash:] are displayed. For the RX family, R8C family, and SuperH family, [User mat], [Data mat], and [User boot] are displayed.

<4> Option area

When the [Show data] check box is checked, the action log window will be displayed when the upload is executed. Pressing the [OK] button will start the upload with the selected settings. Pressing the [Cancel] button will close the dialog box without executing the upload.

(3) [Checksum] command

The [Checksum] command calculates the checksum of the selected program file downloaded to FP5 and displays the result. When this command is executed, the Checksum dialog box appears. Select the optional calculation method and the target address range, and click the [OK] button. The result will then be displayed in the [File Checksum] area in the action log window and programmer parameter window. This command can be executed after the [Setup] command is executed. If the [Setup] command is executed again after the [Checksum] command is executed, the result displayed in the [File Checksum] area in the programmer parameter window will be cleared.

Figure 4-10. Checksum Dialog Box

<R> (a) When a product without data flash is selected from the 78K, V850, RL78 family (b) When a product with data flash is selected from the 78K, V850, RL78 family

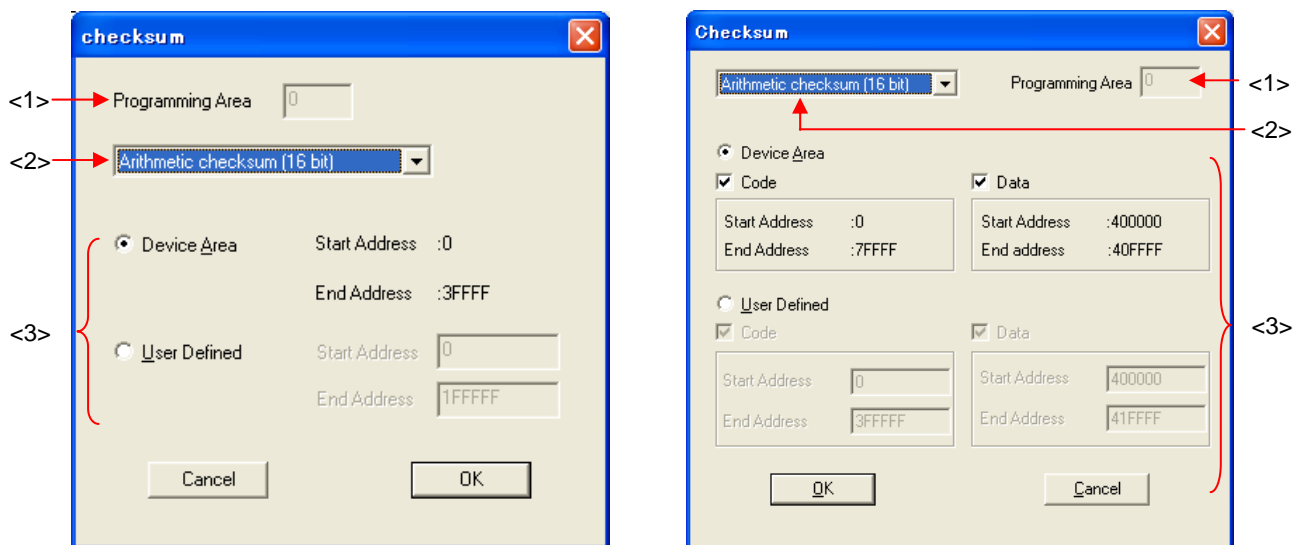

<R> (c) When the RX family, R8C family, or SuperH family is selected

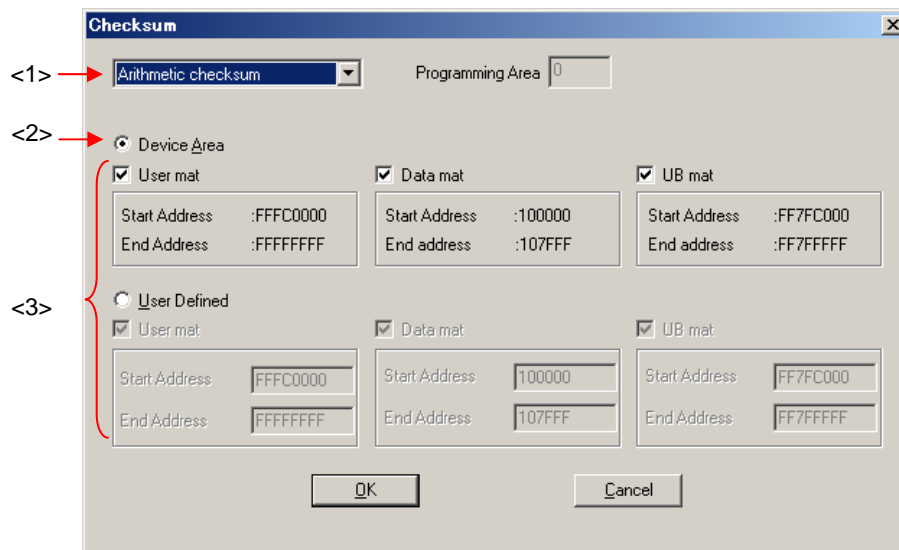

<1> Programming area
The valid programming area is displayed.

<R> <2> Checksum calculation mode selection
Select the mode for calculating checksum of the selected program file.
Arithmetic checksum (16bit): 16-bit arithmetic (subtraction)
Arithmetic checksum: 32-bit arithmetic (addition)
CRC sum (32bit): 32-bit CRC

Remark With the 16-bit arithmetic (subtraction) mode, the lower 4 digits of the result from which a value is subtracted from 00h in 1-byte units are displayed.
With the 32-bit arithmetic (addition) mode, the lower 8 digits of the result to which a value is added from 00h in 1-byte units are displayed.
With 32-bit mode, the 8-digit result of CRC32 function calculation is displayed. For details on arithmetic specifications, refer to **Figure B-2 32-bit CRC Calculation Specifications**.
The 16-bit arithmetic (subtraction) mode can be selected when the 78K, V850, or RL78 family is selected.
The 32-bit arithmetic (addition) mode can be selected when the RX family, R8C family, or SuperH family is selected.

<3> Address range selection

<R> Select the range for calculating checksum of the selected program file. If there is no program file data in the specified range, the specified range is filled with FFh for calculation. When a product with data flash is selected from the 78K, V850, RL78 family, [Code flash:] and [Data flash:] are displayed. When the RX family, R8C family, or SuperH family is selected, [User mat], [Data mat], and [User boot] are displayed.

Device Area: From the start to end addresses of the device, which are contained in the selected PR5 file

User Defined: Any range can be specified by inputting the addresses to the [Start Address] and [End Address] text boxes.

Clicking the **OK** button displays the calculation result in the [File Checksum] area in the action log window and programmer parameter window.

Clicking the **Cancel** button closes the dialog box without saving the settings made in the Checksum dialog box.

Remark When the valid programming area is changed or a program file is downloaded, the checksum result will be cleared.

<R> **Figure 4-11. Checksum Result <When Product without Data Flash Is Selected from 78K, V850, RL78 Family>**

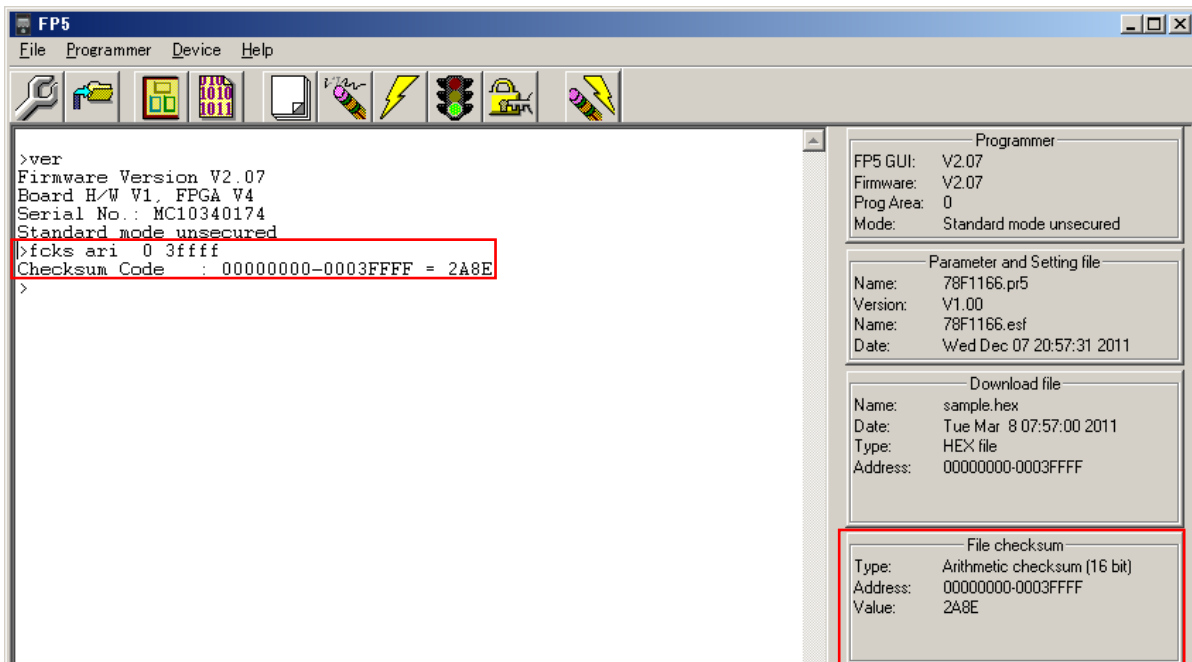

<R>

Figure 4-12. Checksum Result

(a) When Product with Data Flash Is Selected from 78K, V850 or RL78 Family

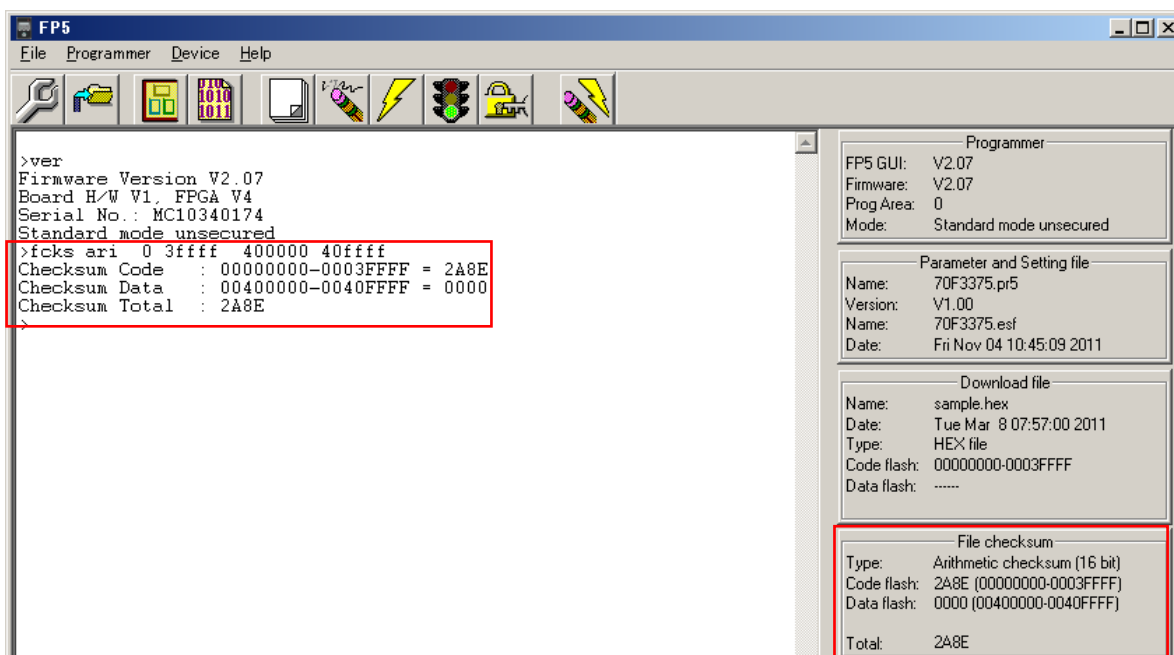

(b) When RX Family, R8C Family or SuperH Family Is Selected

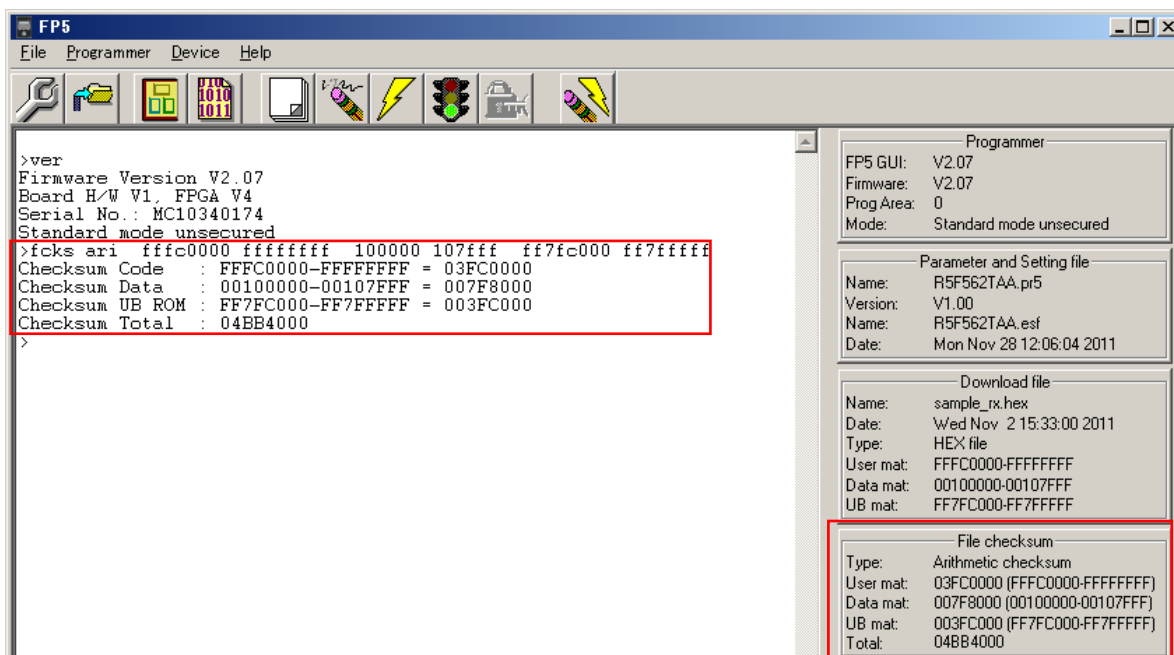

(4) [Quit] command

The [Quit] command terminates the programming GUI. The programming GUI can also be terminated by clicking the button on the right end of the title bar in the main window. When the programming GUI is terminated, various settings are saved in the INI file (FP5.ini), and these settings are loaded when the programming GUI is started the next time.

<R>

4.3.2 [Programmer] menu

Clicking the [Programmer] menu displays the following pull-down menu. This menu includes commands related to FP5 settings.

<R>

Figure 4-13. [Programmer] Menu

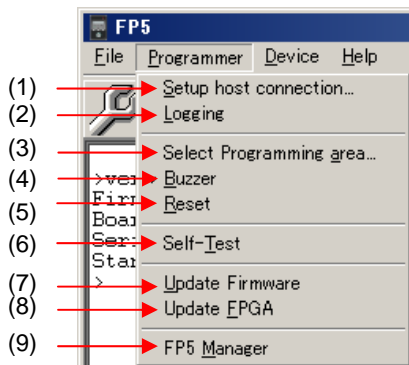

(1) [Setup host connection] command

Running the [Setup host connection] command opens the [Host Connection] dialog box. The channel for communication between the FP5 and the host machine can be selected and configured in this dialog box.

Figure 4-14. [Host Connection] Dialog Box

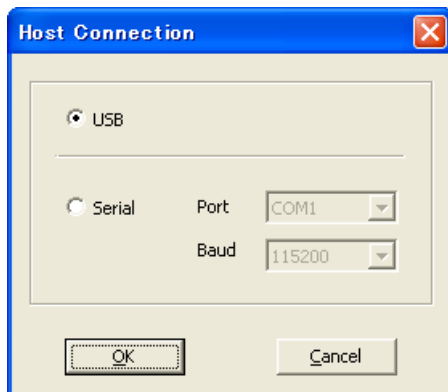

“USB” can be selected as the communication channel if the USB interface is supported in the PC used. When selecting “Serial”, select the COM port and baud rate from the drop-down list boxes. COM ports that are recognized by the host machine are displayed in the Port list. Up to 256 ports can be recognized.

When the **OK** button is clicked, software tries to establish a connection between the FP5 and the host machine using the selected communication channels.

Clicking the **Cancel** button closes the window without making any changes.

(2) [Logging] command

The [Logging] command saves information displayed in the action log window in the log file. When this command is executed, the log file save dialog box appears. Move to an arbitrary folder, select the log file in the [File name] drop-down list, and click the **Save** button; the log file will then be saved. The [Logging] command on the menu bar will be checked. The check mark will be cleared by clicking the [Logging] command again and saving of the log file will be stopped. Enabling/disabling the [Logging] command is added to the time stamp. For a log file example, refer to **Figure B-3 Log File Example**.

Remark The log file that was saved the last time is displayed in the log file save dialog box.

Figure 4-15. Log File Save Dialog Box

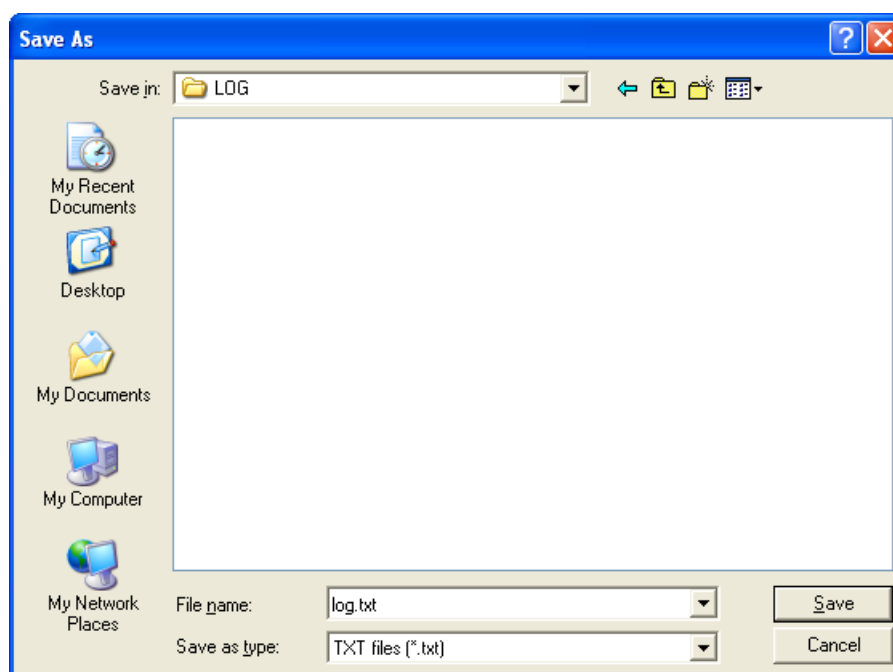

Clicking the **Save** button saves the specified log file.

Clicking the **Cancel** button closes the dialog box without saving the log file.

(3) [Select Programming area] command



The FP5 has a 16 MB flash memory area for saving program files. This memory area can be used as four 4 MB programming areas (Area 0 to Area 3) or eight independent 2 MB programming areas (Area 0 to Area 7). Program files can be downloaded to each programming area, and which file, PR5 or ESF, is to be saved is selectable in programming area units. That is, files can be individually downloaded in each programming area, and the area used can also be selected individually.

This command is used to select a valid programming area from the FP5's four (or eight) programming areas (4 MB in case of four areas, or 2 MB in case of eight areas). When this command is executed, the programming area select dialog box is opened, and the desired programming area can be selected. The number of programming areas that can be selected with this command is the value defined in the [Programming Area Setting] area on the [Target] tab of the Device Setup dialog box, which is opened by the [Setup...] command in the [Device] menu.

Figure 4-16. Programming Area Select Dialog Box

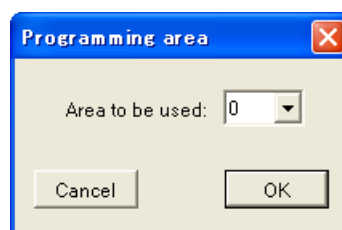

The currently selected programming area is displayed in the programming area selection dialog box. To change the area, select the relevant number from the list box and click the [OK] button. To check the contents set to each area or to change the division factor, see the [Target] tab of the Device Setup dialog box.

Clicking the [OK] button selects the programming area selected in the programming area select dialog box. Clicking the [Cancel] button closes the dialog box without changing the programming area.

(4) [Buzzer] command

The [Buzzer] command is used to enable or disable the setting to output the buzzer sound from the FP5 main unit. When this command is executed, the [Buzzer] command on the menu bar is checked and becomes valid. When this command is executed again, the check mark is cleared and the command becomes invalid. The FP5 makes a double-beep sound when the Autoprocedure(E.P.) command is completed normally, or makes a buzzer sound when the command is completed abnormally.

(5) [Reset] command

When the [Reset] command is executed, a software reset can be applied to the FP5. After reset, the current versions of the firmware, FPGA, the FP5 serial number, and mode will be displayed in the action log window.

(6) [Self-Test] command

The [Self-Test] command executes the FP5 self-testing program. The following three items are subject to self-testing. The self-testing program does not affect the PR5 files, ESF files and program files saved in the FP5.

<1> FPGA test

<2> Power generation block test

<3> Target / remote interface I/O test

Since execution of the [Self-Test] command involves I/O testing, a message that prompts the user to disconnect hardware connected the target connector or remote connector is displayed. Remove hardware (including target system and program adapter), connected to the target connector or remote connector, if any. Make sure that no hardware is connected and click the **OK** button; self-testing will then be executed.

If the **Cancel** button is clicked, self-testing will not be executed.

Figure 4-17. Confirmation Before Starting Self-Testing

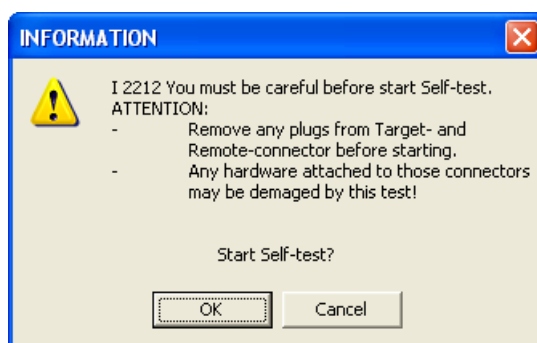

Self-testing takes about three seconds, and the result will be displayed in the action log window and a result dialog box. If the message "Selftest FAILED." is displayed, the cause may be a defect in the FP5, so consult a Renesas Electronics sales representative or distributor.

Figure 4-18. Result When Self-Testing Program Has Been Completed Normally <Action Log Window>

```
>selftest

***** CAUTION *****
Remove any plugs from Target- and Remote-Connector before starting.
Any hardware attached to those connectors may be damaged by this test !
***** CAUTION *****

Target- and Remote-connector unplugged ?
If yes, press 's' to start the test: s

FPGA Test: PASS
Power Supply Test: PASS
Target- and Remote-Interface Test: PASS

Selftest PASSED.
>
```

Figure 4-19. Result When Self-Testing Program Has Been Completed Normally <Result Dialog Box>

Figure 4-20. Example of Result When Self-Testing Program Has Been Completed Abnormally
<Action Log Window>

```
>selftest

**** CAUTION ****
Remove any plugs from Target- and Remote-Connector before starting.
Any hardware attached to those connectors may be damaged by this test !
**** CAUTION ****

Target- and Remote-connector unplugged ?
If yes, press 's' to start the test: s

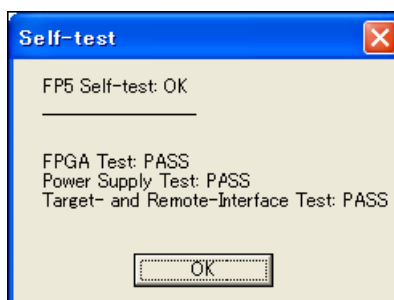
FPGA Test: PASS
Power Supply Test: PASS
Target- and Remote-Interface Test: FAIL

Selftest FAILED.

>
```

Figure 4-21. Example of Result When Self-Testing Program Has Been Completed Abnormally
<Result Dialog Box>

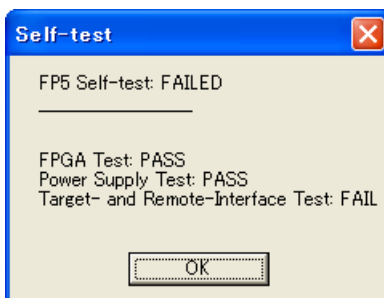

(7) [Update Firmware] command

The [Update Firmware] command updates the firmware. Refer to **3.4 Updating Programming GUI, Firmware and FPGA** and download the relevant update file before starting update.

Executing of this command displays the following dialog box.

Figure 4-22. [Update Firmware] Dialog Box

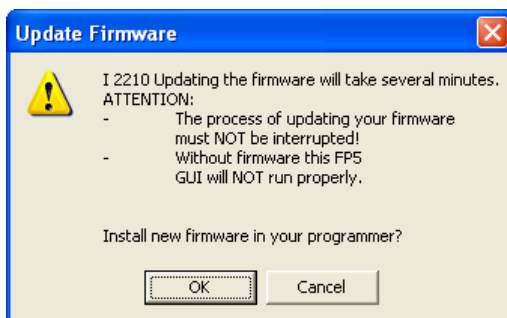

To continue the firmware update, click the **OK** button.

Clicking the **Cancel** button cancels the firmware update.

Clicking the **OK** button opens the [Open firmware file] dialog box.

Figure 4-23. [Open firmware file] Dialog Box

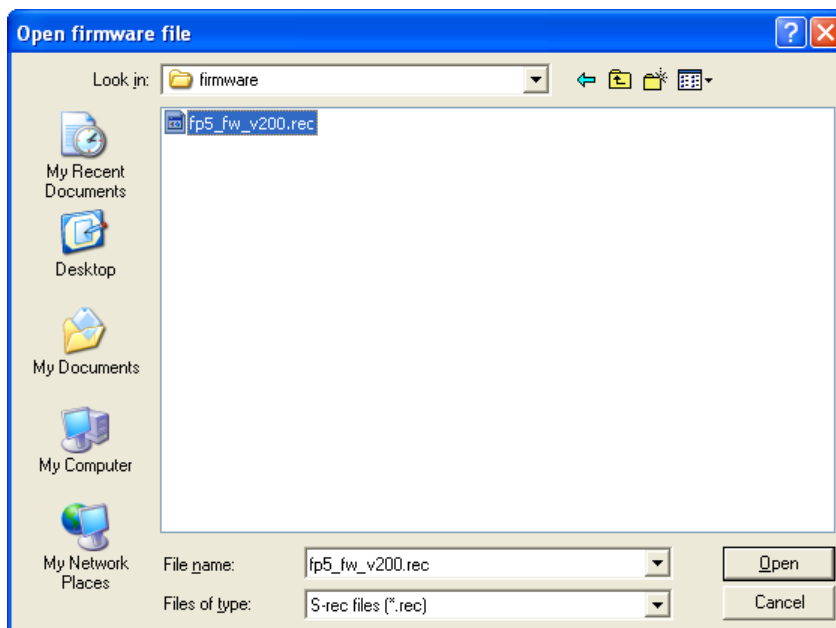

Select the firmware file “fp5_fw_vxxx.rec” and then click the **Open** button.

- Cautions**
1. Do not use FP5 firmware other than the one posted on the website; otherwise, a defect may occur.
 2. When a firmware of FP5 updates from V2.00 to V1.xx, a serial number of FP5 is erased. And, FP5 can't operate in USB1.1. In addition, the other functions don't have any problem. When FP5 revives, consult a Renesas Electronics sales representative or distributor.

Some commands are sent to the FP5 and the update progress status is displayed in the action log window. The message "Firmware Update succeeds", which indicates normal completion of firmware update, and "Restarting FP5...", which is equivalent to [RESET] command processing, is automatically performed. The new version can then be checked as "Firmware Version Vx.xx". The update takes about 10 seconds.

<R>

Figure 4-24. Action Log Window When Firmware Update Is Finished

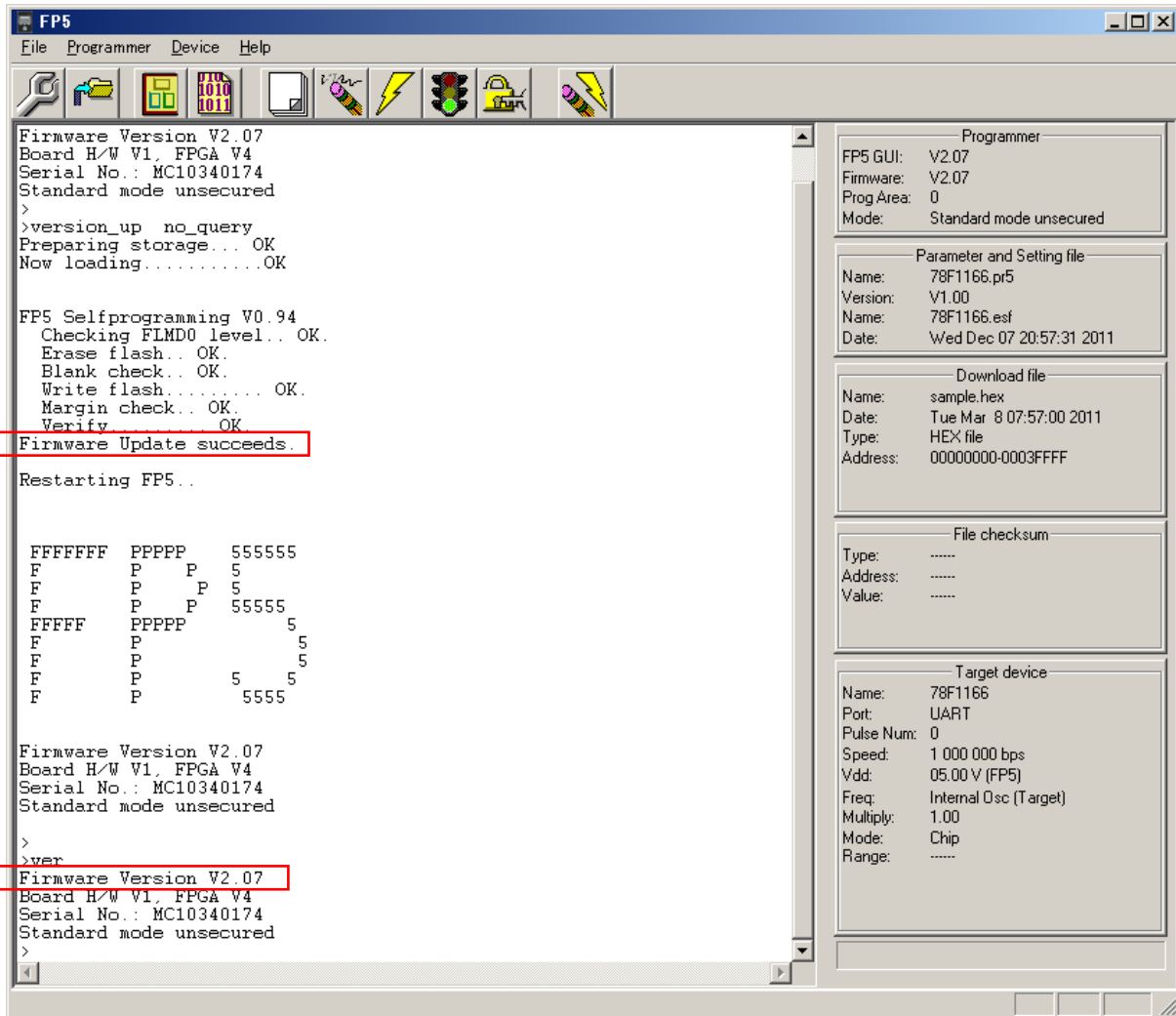

Remark Depending on the changes made, the following dialog box will be displayed. In this case, the information stored in the FP5 (PR5 file, ESF file, program file) will have been deleted, so please download those files again. (Refer to 4.2 Starting the Programming GUI.)

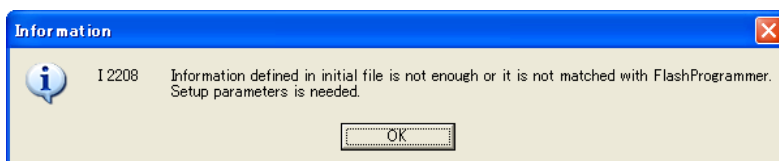

(8) [Update FPGA] command

The [Update FPGA] command updates the FPGA. Refer to 3.4 **Updating Programming GUI, Firmware and FPGA** and download the relevant update file before starting update.

Executing of this command displays the following dialog box.

Figure 4-25. [Update FPGA] Dialog Box



To continue the FPGA update, click the **OK** button.

Clicking the **Cancel** button cancels the FPGA update.

Clicking the **OK** button opens the [Open FPGA file] dialog box.

Figure 4-26. [Open FPGA file] Dialog Box

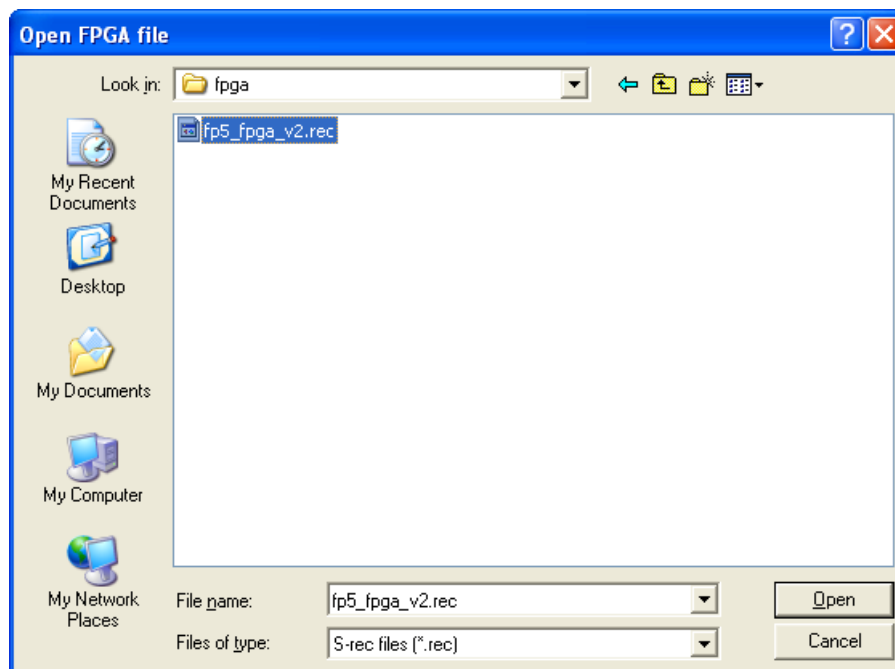

Select the FPGA file “fp5_fpga_vx.rec” and then click the **Open** button.

Caution Do not use FP5 FPGA other than the one posted on the website; otherwise, a defect may occur.

Some commands are sent to the FP5 and the update progress status is displayed in the action log window. The message "FPBGA Upload succeeded.", which indicates normal completion of firmware update, and "FP5 Power will be switched OFF now.....", which is equivalent to processing when the **POWER** button is turned off, is automatically executed. The update takes about 30 seconds.

<R>

Figure 4-27. Action Log Window When FPGA Update Is Finished

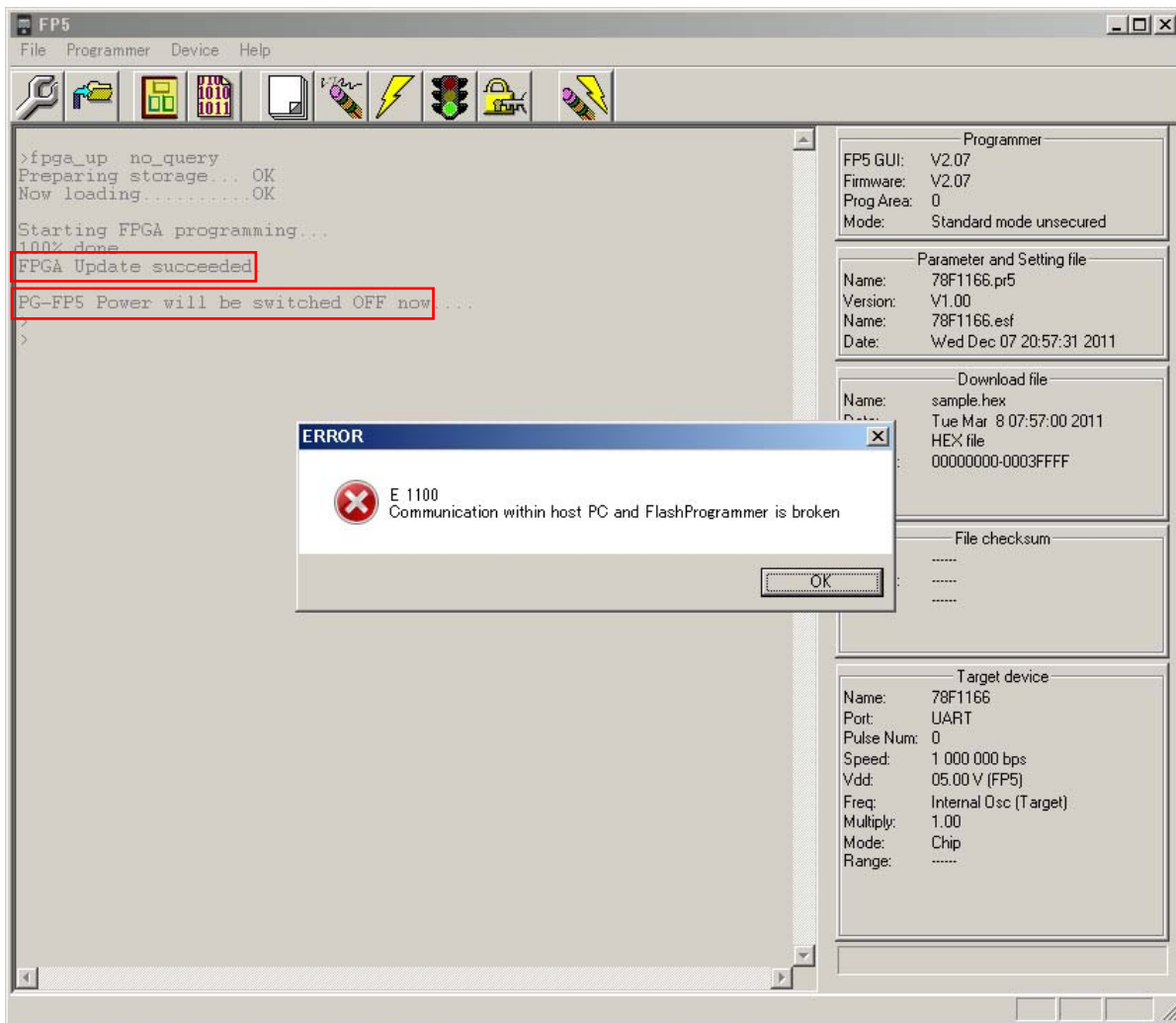

Click the **OK** button in the error message dialog box and then press the **POWER** button on the FP5 to turn on power.

Execution of the [Setup host connection...] command opens the [Host Connection] dialog box. Select the communication mode used and then click the **OK** button.

<R>

Figure 4-28. [Setup host connection] Command

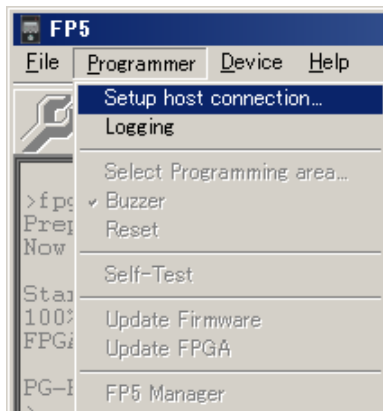
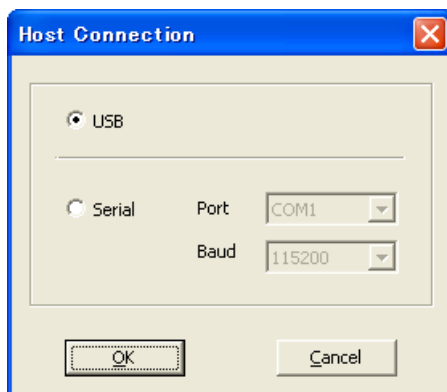

Figure 4-29. [Host Connection] Dialog Box



The main window is opened. "Board H/W V1, FPGA Vx" is displayed in the action log window; thus, the version can be checked.

<R>

Figure 4-30. Version Confirmation After FPGA Update Is Finished

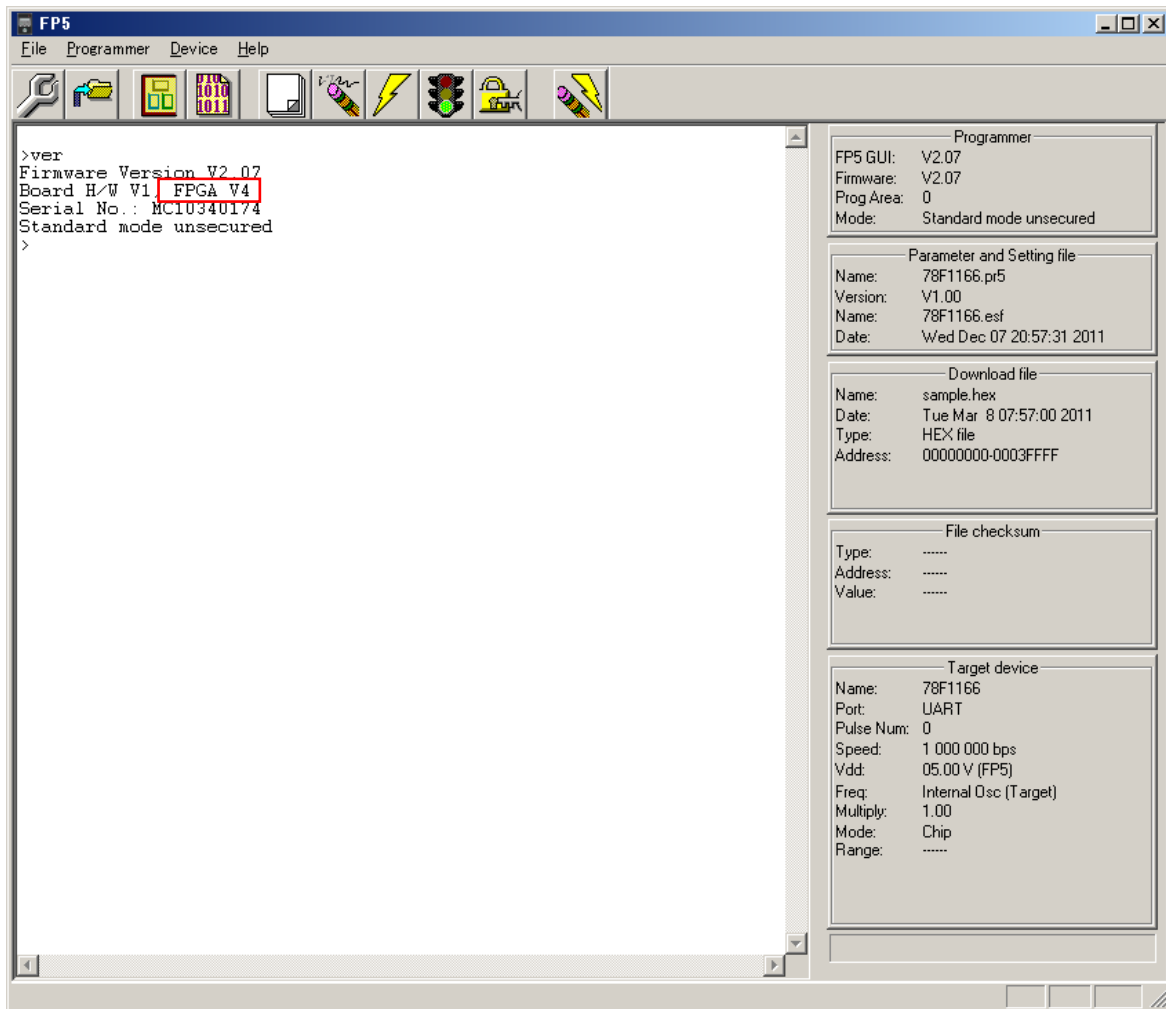

(9) [FP5 Manager] command

The [FP5 Manager] command sets the FP5 management functions. These functions include the following: The password function, the upload prohibit function, the device setup prohibit function, the bank mode enable function, the simple mode enable function, the checksum comparison function, the program file size monitoring function, and the reset terminal property switching function.

<R>

When the [FP5 Manager] command is executed, the following dialog will be opened.

Figure 4-31. Welcome to FP5 Manager Dialog Box



Clicking will open the following dialog box.

If a password is not registered, the dialog box in Fig. 4-32 will open.

If a password is registered, the dialog box in Fig. 4-33 will open.

Clicking will close the dialog box.

Figure 4-32. Password setting Dialog Box



In order to register a password, input a password into the [PASSWORD] box and [Confirm PASSWORD] box, and then click .

The password must be made up of up to eight alphanumeric characters. (Differences in upper and lower case are not recognized.)

Clicking will close the dialog box.

Figure 4-33. Login to FP5 Manager Dialog Box

Input the password into the [PASSWORD] box, and then click **OK**.

If the password is correct the dialog box in Figure 4-35 will open. If the password is wrong, then the dialog box in Figure 4-34 will open.

Clicking **Cancel** will close the dialog box.

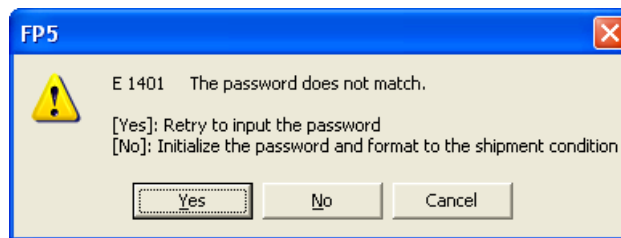
Figure 4-34. FP5 Dialog Box

Clicking **Yes** will open the dialog box to input the password again (Figure 4-33).

Clicking **No** will initialize the FP5 to its default settings. When initialized, the following stored information will be deleted or reset to their defaults:

- Password
- FP5 Manager setting
- PR5 file
- ESF file
- Program file

Clicking **Cancel** will close the dialog box.

Figure 4-35. FP5 Manager Dialog Box

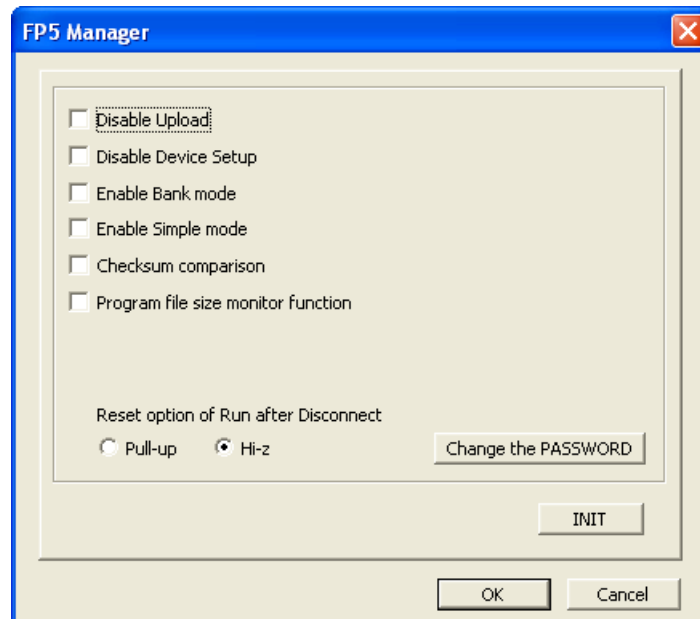

After making any changes to the settings and clicking **OK**, the dialog box will close and the settings will be enabled. Clicking **Cancel** will close the dialog box and discard the changes. The FP5 Manager settings are described below.

• Displaying Mode Contents

The mode contents that indicate the FP5 state is displayed in the [Programmer] area of the programming parameter window.

- Standard mode unsecured
The FP5 Manager has not been set.
- Standard mode secured
The FP5 Manager has been set. However, the bank mode or the simple mode have not been set.
- Bank mode secured
The FP5 Manager and bank mode have been set.
- Simple mode secured
The FP5 Manager and simple mode have been set.

• FP5 Manager Dialog Settings (Refer to Figure 4-35)

[Disable Upload] check box

This sets enabling or disabling of the upload function used to upload data (program file, PR5 file, ESF file) from the valid programming area of FP5 to the host machine. Checking the box will disable and unchecking it will enable the function. When this function is disabled, the [File] menu -> [Upload from FP5...] command, and the hex and srec of the communications command are disabled. The default is not to have this box checked.

[Disable Device Setup] check box

Enables or disables the [Setup] command in the [Device] menu. It is disabled when checked, and enabled when not checked. When it is disabled, the [Setup] command in the [Device] menu, as well as the downprm, downset, and lod communication commands become invalid.

[Enable Bank mode] check box

Sets the normal mode or bank mode for the mode of the remote connector. Checking this box will set the bank mode, and not checking it will set the normal mode. If checked, [Enable Simple mode] cannot be checked. When in the bank mode, the programming area can be selected through the remote connector. With respect to detailed functions, refer to **CHAPTER 7 USAGE THE REMOTE CONNECTOR**. The default is not to have this box checked.

[Enable Simple mode] check box

Sets the normal mode or the simple mode. Checking this box will set the simple mode, and not checking it will set the normal mode. If checked, [Enable Bank mode] cannot be checked. When in the simple mode, the functions of the FP5 control buttons and message display will change. When the **NEXT** button is clicked, the programming area will be switched. Clicking the **ENTER** button or **START** button will execute the Autoprocedure(E.P.) command. The message display will display (1) the programming area number, (2) the program file name, and (3) the checksum and (4) command name. Immediately after the program file is downloaded, the checksum will show H:xxxxxxx. At this time, the program file will be checked using 32-bit CRC calculations from the start to the end address. After this, executing [File] menu -> [Checksum] command will display F:xxxxxxx. The default is not to have this box checked.

Figure 4-36. Example of Message Display

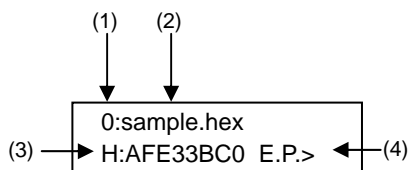

[Checksum comparison] check box

When [Device] menu -> [Checksum] command is executed and the checksum of the target device is displayed, the checksum of the program file stored in FP5 will be referenced and the results displayed. Checking this box will cross-reference the checksum, and not checking it will not. The default is not to have this box checked.

Figure 4-37. Example of Action Log Window

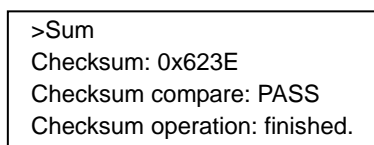

[Program file size monitor function] check box

Halts execution of programming commands if the program file size exceeds the programmable range. If this check box is checked and the address range of the downloaded program file exceeds the address range specified in the [Operation Mode] area on the [Standard] tab of the Device Setup dialog box, executing a [Program], [Verify], or [Autoprocedure(E.P.)] command will cause the error message “ERROR (E302): Hex file exceeds target device flash range.” to appear in the Action Log window and execution of the command will halt. If this check box is not checked, the warning message “WARNING: HEX file exceeds target device flash range.” will appear in the Action Log window, but execution of the command will continue. The default is not to have this box checked.

[Reset option of Run after Disconnect]

When the [Run after Disconnect] function in the [Command options] area of the Device setup dialog [Advanced] tab is enabled, the properties of the $\overline{\text{RESET}}$ signal after the write command is completed can be set to Pull-up or Hi-Z. The default is Hi-Z.

[Change the PASSWORD] button

Clicking the [Change the PASSWORD] button will open the following dialog box.

Figure 4-38. Password setting Dialog Box



This dialog box allows the user to change the registered password.

Input the current password into the [OLD PASSWORD] box, input the new password into the [NEW PASSWORD] box and [Confirm PASSWORD] box, and then click [OK]. When [Cancel] is clicked, the dialog box will be closed and the password will not be changed.

[INIT] button

Resets the FP5 to its default settings. Initializing the FP5 will reset or delete the following stored information.

- Password
- FP5 Manager setting
- PR5 file
- ESF file
- Program file

4.3.3 [Device] menu

The following pull-down menu appears by clicking the [Device] menu.

This menu includes commands mainly related to programming to the target device, such as erase, write and verify.

Figure 4-39. [Device] Menu

(a) When 78K, V850, RL78 Family Is Selected

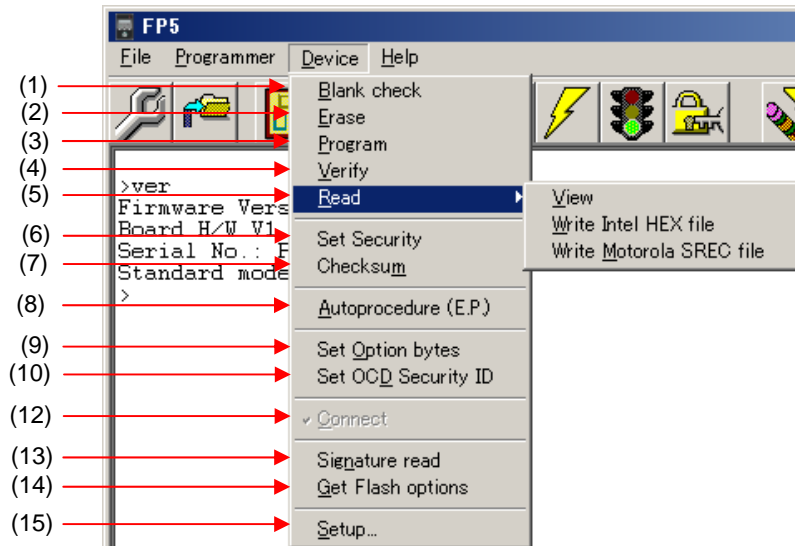

<R>

(b) When RX Family, R8C Family or SuperH Family Is Selected

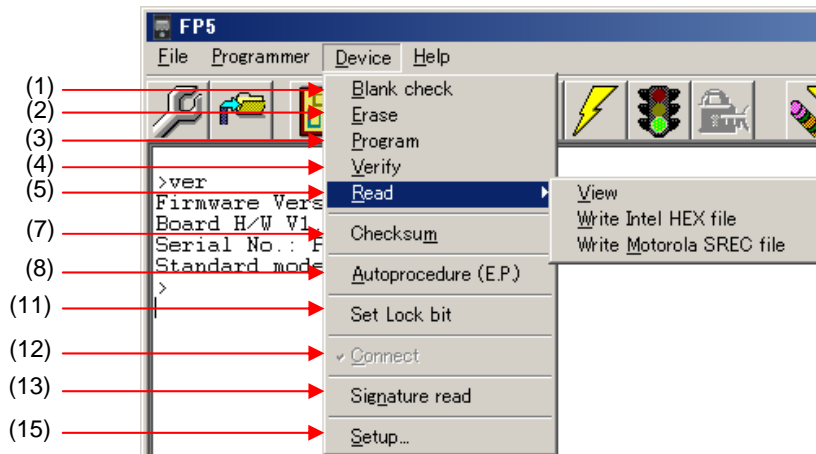

(1) [Blank check] command



The [Blank Check] command performs blank check for the flash memory in the target device. The target area can be set in the [Operation Mode] area on the [Standard] tab in the Device Setup dialog box. If the flash memory has already been erased, "PASS" is displayed. If the flash memory has not yet been erased, "ERROR" is displayed. If this error is displayed, erase the entire area of the flash memory before starting programming.

(2) [Erase] command

The [Erase] command erases the flash memory in the target device. The target area can be set in the [Operation Mode] area on the [Standard] tab in the Device Setup dialog box. If this command is executed with [Chip] selected, security command options are initialized at the same time. While erasing the flash memory is in progress, the progress status is displayed in the action log window. When execution of this command is completed, the result of command execution in the target device is displayed. Whether to perform the [Blank Check] command before executing this command depends on the [Blank check before Erase] check box setting in the [Command options] area on the [Advanced] tab in the Device Setup dialog box. If this command is executed for the target device that has already been erased with the [Blank check before Erase] check box selected, "OK, Erase skipped." is displayed and erasure is not performed.

(3) [Program] command

The [Program] command transmits the memory contents (program files) in the FP5 valid programming area to the target device and writes the programs to the flash memory. The target area can be set in the [Operation Mode] area on the [Standard] tab in the Device Setup dialog box. The progress status of this command is displayed as a percentage in the action log window. When execution of this command is completed, the programming GUI displays the result of command execution in the target device. Command options after execution of this command depend on the settings of the [Verify after Program], [Security after Program] and [Checksum after Program] check boxes in the [Command options] area on the [Advanced] tab in the Device Setup dialog box. For details on these check boxes, refer to 4.3.3 (15) (c) <2> [Command options] area.

<R> (4) [Verify] command

For the 78K, V850, and RL78 family, the [Verify] command transmits the memory contents (program files) in the FP5 valid programming area to the target device, verifies the data written to the flash memory in the target device, and receives the result. For the RX family, R8C family, and SuperH family, it reads data from the microcontroller, and compares it with the memory content (program file) in the effective programming area of the FP5. The target area can be set in the [Operation Mode] area on the [Standard] tab in the Device Setup dialog box. The progress status of this command is displayed as a percentage in the action log window. When execution of this command is completed, the programming GUI displays the result of command execution in the target device.

<R> (5) [Read] command

The [Read] command loads data on the flash memory in the target device and saves it as a file. The target range of the flash memory is specified in the [Operation Mode] area on the [Standard] tab of the Device Setup dialog box. When the [View] command is executed following this command, 4 KB read data is displayed in the log window each time the ENTER key is pressed. When the [Write Intel HEX file] or [Write Motorola SREC file] command is executed following this command, the read data can be saved in the Intel HEX format or Motorola HEX format. Use of the saved file with other tool products is not supported.

Remark The folder in which program data was saved the last time is displayed in the program data save dialog box.

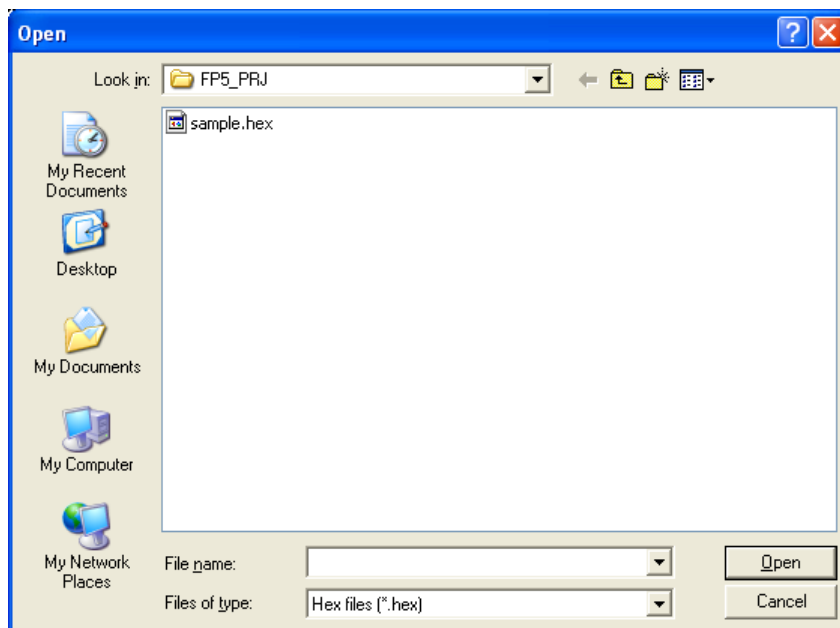
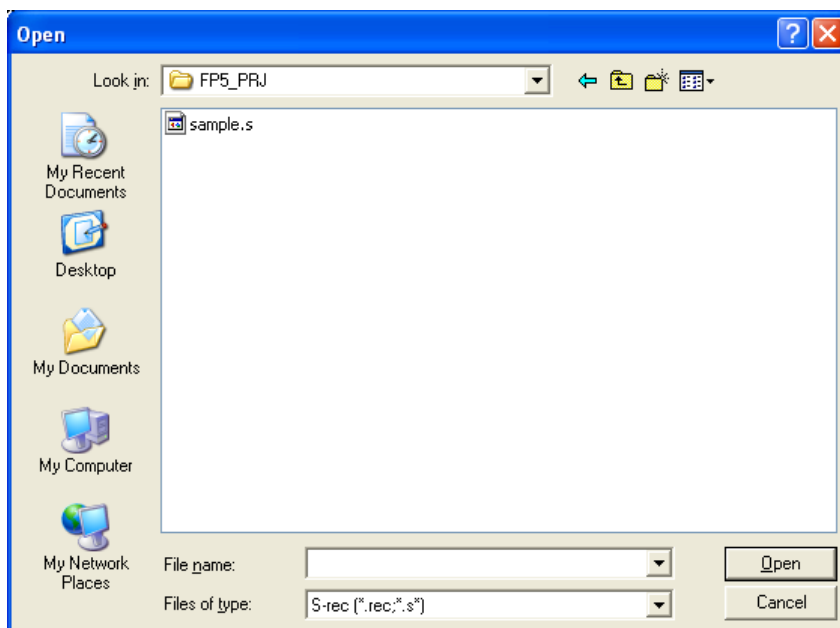
Figure 4-40. Program Data Saved Dialog Box <When Write Intel HEX file Command Is Executed>**Figure 4-41. Program Data Save Dialog Box <When Write Motorola SREC file Command Is Executed>**

Clicking the **Open** button saves the program data into a file and closes the dialog box.

Clicking the **Cancel** button closes the program data save dialog box without saving the program data into a file.

(6) [Set Security] command

The [Set Security] command sets the security functions for the target device. When this command is executed, the settings made in the [Set Security command options] area on the [Advanced] tab in the Device Setup dialog box will be reflected in the target device. For details on the security functions, refer to **4.3.3 (15) (c) <4> [Set Security command options] area**.

<R> (7) [Checksum] command

For the 78K, V850, RL78 family, RX family, and SuperH family, the [Checksum] command reads the checksum calculated in the target device and displays it in the action log window. When using a 78K0S/Kx1+ microcontroller or the μ PD78F9334, this command also displays the checksum of the program file and compares both. For the R8C family, it reads the content of the flash memory of the target device, and displays the checksum calculated in the FP5 on the action log window.

Remark The checksum read by this command differs from the one displayed in the [File checksum] area in the programmer parameter window. For details on the [File checksum] area, refer to **4.3.1 (3) [Checksum...] command**.

The checksum is calculated as follows. Note that this is the result when the [Enable Checksum Compare Function] check box of the FP5 management Setting (M) dialog box is not selected.

<When using 78K (other than 78K0S/Kx1+, μ PD78F9334), V850E1, V850ES, RL78 family>

Method: Subtraction (16-bit arithmetic)

Range: Area set in the [Operation Mode] area on the [Standard] tab in the Device Setup dialog box

Figure 4-42. Action Log Window After [Checksum] Command Execution
<When using 78K (Other than 78K0S/Kx1+, μ PD78F9334), V850E1, V850ES, RL78 Family>

```
>sum
Code flash: 0x8FCD
Data flash: 0x1000
Total: 0x9FCD
PASS
Checksum operation finished.
>
```

Remark With the 16-bit arithmetic (subtraction) mode, the lower 4 digits of the result from which a value is subtracted from 00h in 1-byte units are displayed.

<When using a 78K0S/Kx1+ microcontroller or μ PD78F9334>

Method: Division (original)

Range: Area set in the [Operation Mode] area on the [Standard] tab in the Device Setup dialog box

**Figure 4-43. Action Log Window After [Checksum] Command Execution
(When using 78K0S/Kx1+ microcontroller or μ PD78F9334)**

```
>sum
Device Checksum: 0x1842
FP5 Checksum: 0x1842
Checksum compare: PASS
Checksum operation finished.
>
```

Remark For details on the arithmetic specifications, refer to **Figure B-4 Division (Original) Calculation Specifications**.

<V850E2>

Method: 32-bit CRC

Range: Area specified in the [Operation Mode] area on the [Standard] tab in the Device Setup dialog box

**Figure 4-43. Action Log Window After [Checksum] Command Execution
(V850E2)**

```
>sum
Code flash: 0x370A7BE5
Data flash: 0xBF6D1B03F
Total: 0xF6DC2C24
PASS
Checksum operation finished.
>
```

Remark 32-bit CRC displays the 8-digit result of CRC32 function operation. For the calculation specifications, refer to **Figure B-2 32-bit CRC Calculation Specifications** in **APPENDIX B SUPPLEMENTARY INFORMATION**.

<RX family, R8C family, SuperH family>

Method: 32-bit arithmetic (addition) mode

Range: Result of calculating all the areas (user mat, data mat, user boot) selected in the [Operation Mode] area on the [Standard] tab of the Device Setup dialog box

**Figure 4-43. Action Log Window After [Checksum] Command Execution
(RX Family, R8C Family, SuperH Family)**

```
>sum
User mat: 0x03FC0000
Data mat: 0x00444588
User Boot mat: 0x003FC000
Total: 0x04800588
PASS
Checksum operation finished.
>
```

Remark With the 32-bit arithmetic (addition) mode, the lower 8 digits of the result to which a value is added from 00h in 1-byte units are displayed.

(8) [Autoprocedure(E.P.)] command



The [Autoprocedure(E.P.)] command executes the [Erase] and [Program] commands in succession. Exiting from the flash memory programming mode is not possible between the [Erase] and [Program] commands. The target area can be set in the [Operation Mode] area on the [Standard] tab in the Device Setup dialog box. The progress status of this command is displayed in the action log window. When execution of this command is completed, the programming GUI displays the result of command execution in the target device. Command options after execution of this command depend on the settings of the [Blank check before Erase], [Verify after Program], [Security after Program], and [Checksum after Program] check boxes in the [Command options] area on the [Advanced] tab in the Device Setup dialog box. For details on these check boxes, refer to 4.3.3 (15) (c) <2> [Command options] area.

Figure 4-44. Action Log Window After [Autoprocedure(E.P.)] Command Execution

```
>ep
Blank check Chip:
PASS, Erase skipped.
Program Chip:
10%
20%
30%
40%
50%
60%
70%
80%
90%
100%
PASS
Erase, Program operation finished.
>
```

(9) [Set Option bytes] command

The [Set Option bytes] command specifies the settings for the target device's option byte. When this command is executed, the settings specified in the [Option byte setting] area on the [Advanced] tab of the Device Setup dialog box are applied to the target device. For details of the option byte settings, see **4.3.3 (15) (c) <9> [Option byte setting] area**.

(10) [Set OCD Security ID] command

The [Set OCD Security ID] command specifies the settings for the target device's option byte. When this command is executed, the settings specified in the [OCD ID setting] area on the [Advanced] tab of the Device Setup dialog box are applied to the target device. For details of the OCD security ID settings, see **4.3.3 (15) (c) <8> [OCD ID setting] area**.

<R> (11) [Set Lock bits] command

The [Set Lock bits] command specifies the lock bits of the target device. When this command is executed, the settings specified in the [Set Lock bits] area on the [Advanced] tab in the Device Setup dialog box are reflected to the target device. For details about lock bit settings, refer to **4.3.3 (15) (c) <10> [Set Lock bits] area**.

(12) [Connect] command

Executes the con command or dcon command. When the con command is executed a check will be added and when the dcon command is executed the check will be removed. When "autocon off" or "autocon on" is executed with the autocon command, the [connect] command is enabled or disabled. Refer to **CHAPTER 8 USAGE COMMUNICATION COMMANDS** for details about the functions.

(13) [Signature read] command

The [Signature read] command reads target device product information, such as the device name and flash memory information.

The read result is displayed in the action log window.

<R> (14) [Get Flash options] command

The [Get Flash options] command reads the settings for the flash options for the target device and displays the result in the [Flash options] area on the [Advanced] tab in the Device Setup dialog box. When execution of this command is enabled, execute this command before the [Set Security] command, [Set Option bytes] command, or [Set OCD Security ID] command; the settings for the security functions or the boot area can thus be checked. For details on the flash option settings, refer to **4.3.3 (15) (c) <3> [Flash options] area**.

Caution When loading an HCUHEX file, the HCUHEX file is handled as master data, so even though the flash option settings specified for the device can be checked by executing the [Get Flash Options] command, these settings cannot be applied to the device. The **OK** button in the Device Setup dialog box is therefore unavailable. In this case, click the **Cancel** button and close the Device Setup dialog box. Note that the **OK** button becomes available if the HCUHEX file is changed to a HEX file in the [Object HEX file] area. After changing the file, the HCUHEX file information remains unchanged in the [Command Options] and [Flash options] areas.

Figure 4-45. [Get Flash options] Command

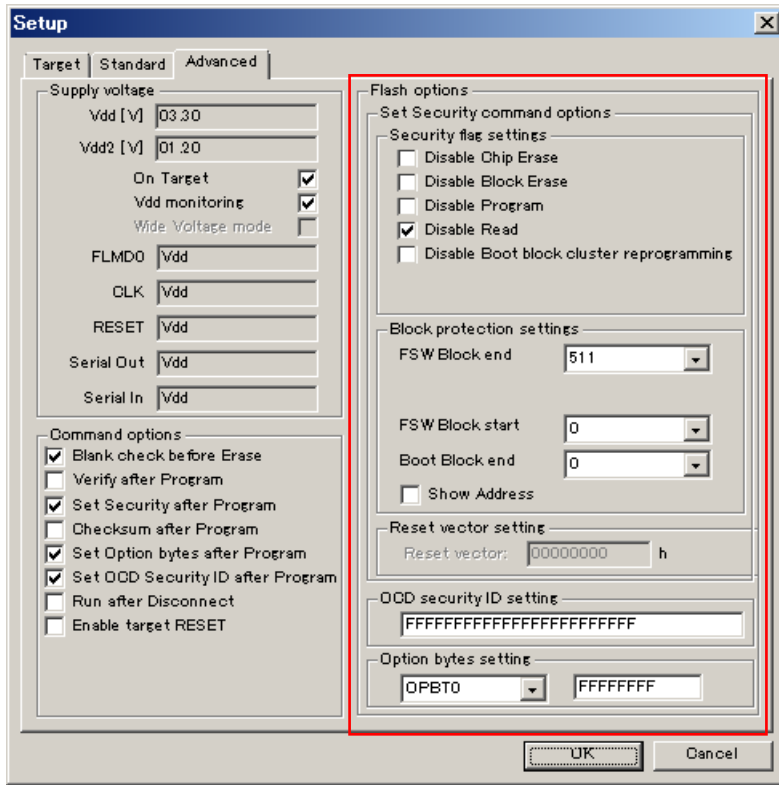

<R> (15) [Setup] command



When the [Setup...] command is executed, the Device Setup dialog box is opened. In this dialog box, select a program file, perform settings in accordance with the user environment for flash memory programming, set command option and option data etc.. Each time the programming GUI is started, the programming GUI loads the PR5 file, ESF file and program file that were used last and displays the settings. Settings for the items not dimmed can be changed in accordance with the user environment. Switch the [Target], [Standard] and [Advanced] tabs for setting.

Figure 4-46. Device Setup Dialog Box

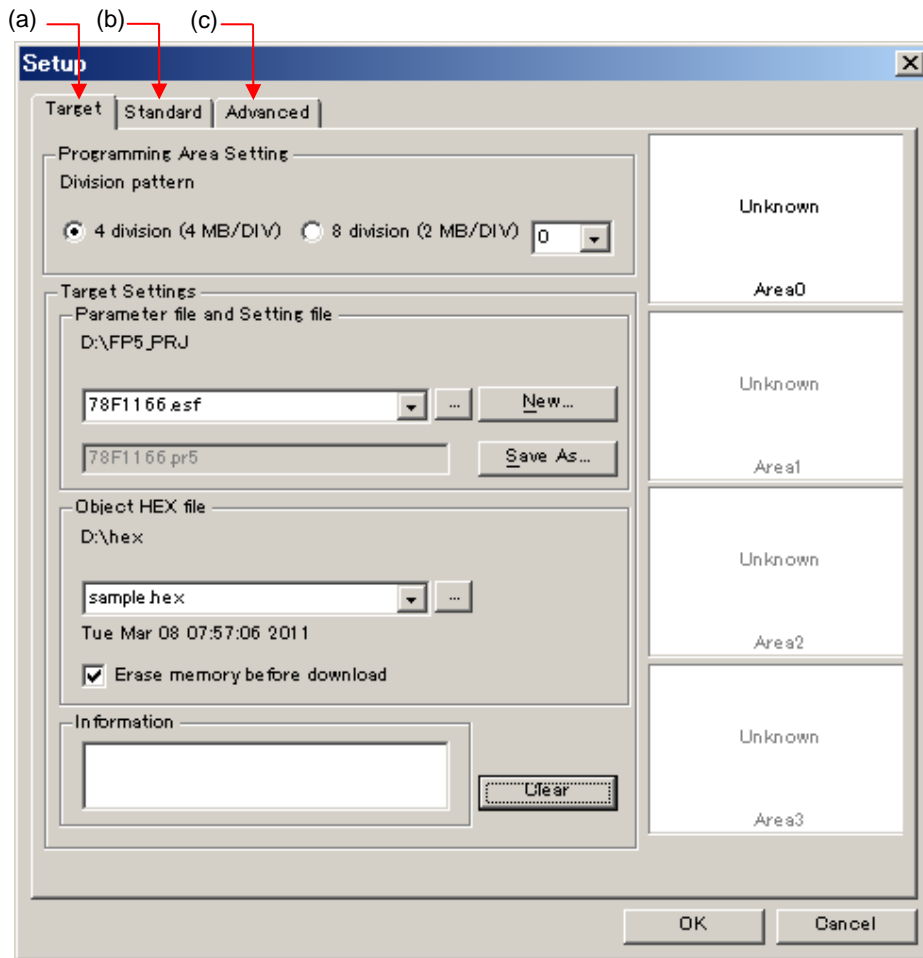

When the **OK** button (button common to [Target], [Standard] and [Advanced] tabs) is clicked, program areas are cleared and PR5 files, ESF files and program files are downloaded for the FP5. After that, the settings made on the [Target], [Standard] and [Advanced] tabs are saved into an ESF file. These settings are reflected to the programming parameter window. If there are settings which have not been updated, the files related to the settings are not downloaded. When a program file is downloaded, the date and checksum (An empty area will be supplemented by FFh when it is downloaded to FP5.) of that file are displayed in the action log window. The checksum is calculated as shown below. For details of the arithmetic specifications, refer to **Figure B-2 32-bit CRC Calculation Specifications**.

Method: 32-bit CRC

Range: From the start to end addresses in the program file

When the **Cancel** button (button common to [Target], [Standard] and [Advanced] tabs) is clicked, the dialog box is closed without saving changed settings on the [Target], [Standard] and [Advanced] tabs into an ESF file.

<R> **Figure 4-47. Clearing of Programming Area, PR5 Files and ESF Files, and Download of Program File**

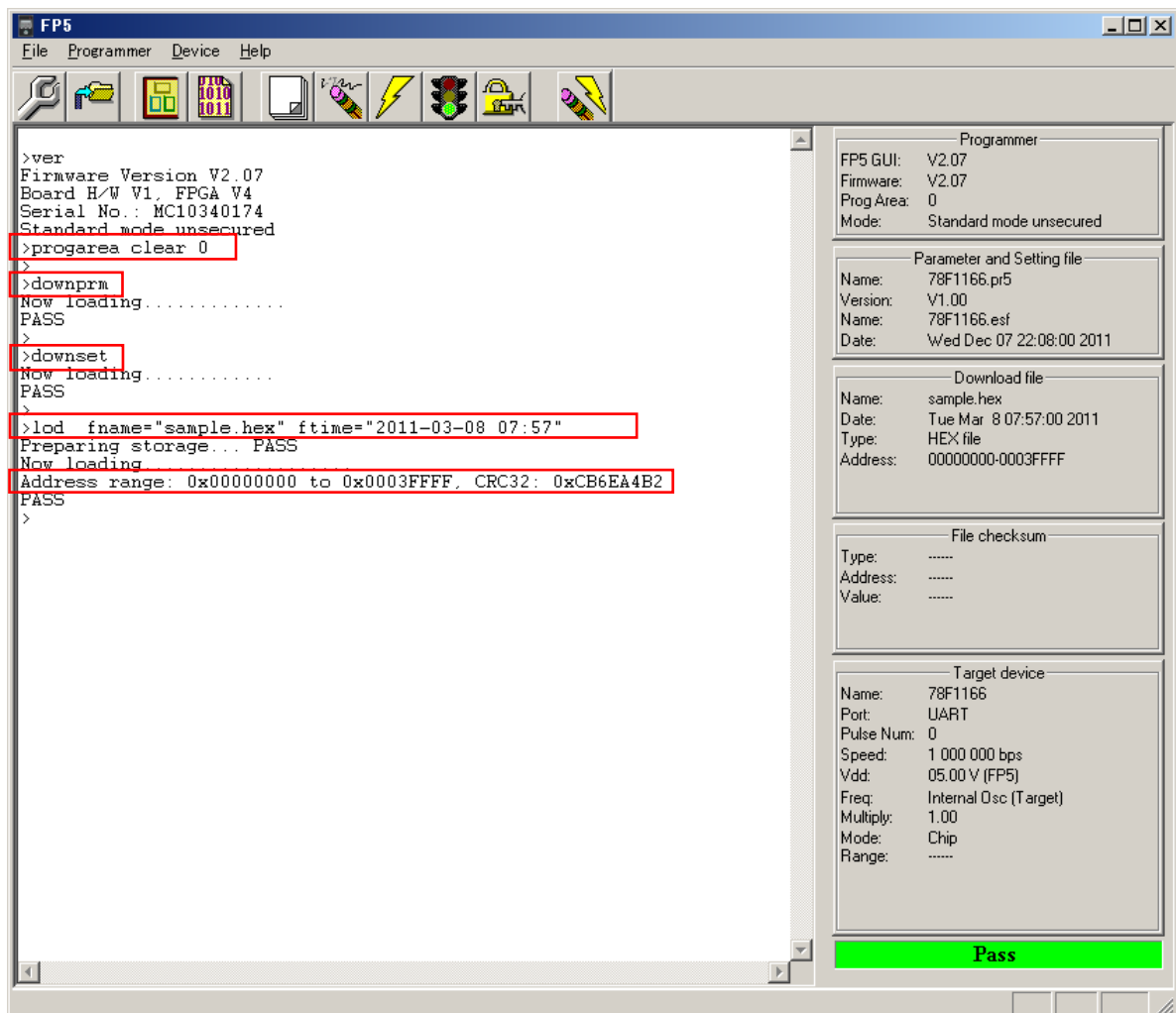

(a) [Target] tab in Device Setup dialog box
 Settings related to programming areas, PR5 files, ESF files and program files can be performed on the [Target] tab in the Device Setup dialog box. This tab consists of the following items.

- <1> [Programming Area Setting] area
- <2> [Target Setting] area
- <3> [Parameter and Setting file] area
- <4> [Object HEX file] area
- <5> [Information] area and **Clear** button
- <6> Programming area map area

<R>

Figure 4-48. Device Setup Dialog Box - [Target] Tab

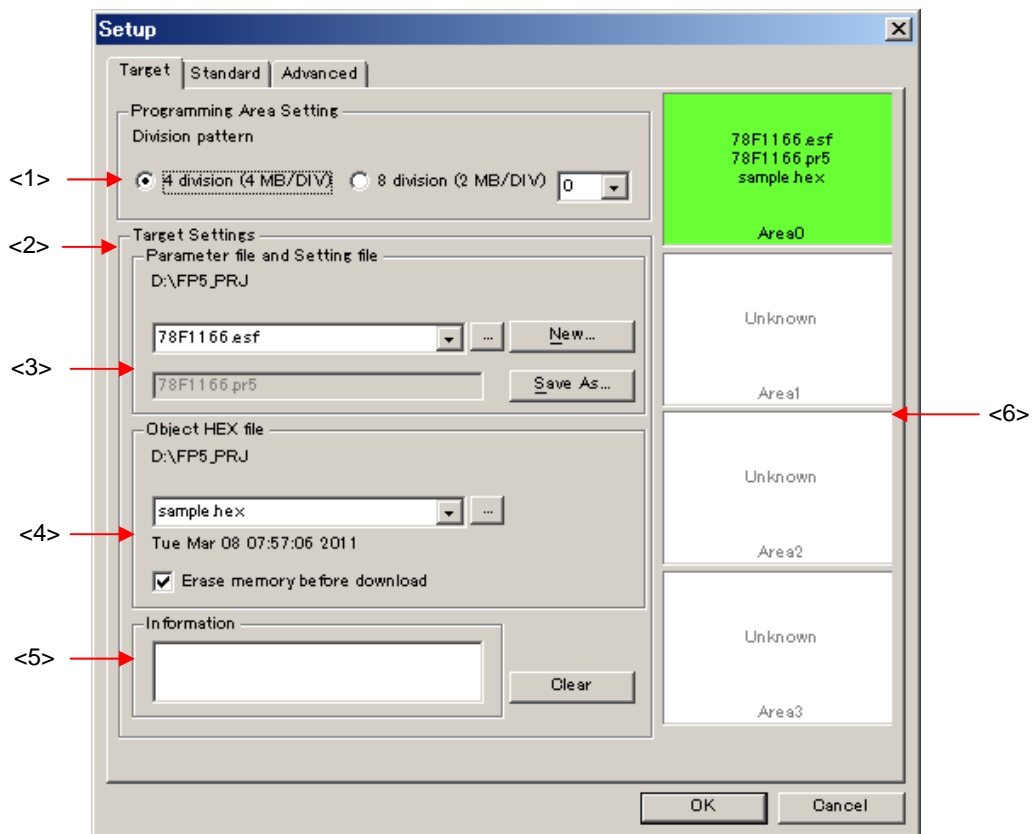

<1> [Programming Area Setting] area

The FP5 has a 16 MB flash memory area for saving program files. This memory area can be used as four 4 MB programming areas (Area 0 to Area 3) or eight independent 2 MB programming areas (Area 0 to Area 7). Program files can be downloaded to each programming area, and which file, PR5 or ESF, is to be saved is selectable in programming area units. That is, files can be individually downloaded in each programming area, and the area used can also be selected individually.

In this area, the factor for dividing the programming area can be selected from 4 (4 MB per area) or 8 (2 per area). If the division factor is changed, data on the programming area map is cleared. In addition, the valid programming area can be selected. If the valid programming area is changed, the focused area in the [Programming area map] area is also changed. By default, the division factor is set to 4 and programming area 0 is selected.

Figure 4-49. [Programming Area Setting] Area

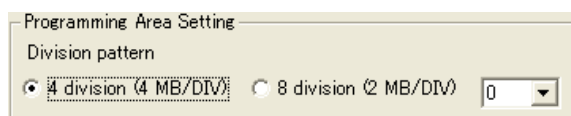

[Division pattern] radio buttons

4 division (4 MB/DIV): The division factor is set to 4 (4 MB per area).

8 division (2 MB/DIV): The division factor is set to 8 (2 MB per area).

[Programming Area Setting] list

If "4 division (4 MB/DIV)" is selected, the valid programming area is selected from areas 0 to 3.

If "8 division (2 MB/DIV)" is selected, the valid programming area is selected from areas 0 to 7.

<2> [Target Setting] area

In this area, ESF files can be created and selected, and PR5 files and program files can be selected. A warning message will be displayed in the [Information] area if there is a mismatch between PR5 files, ESF files and program files saved in the FP5 and information held in the programming GUI. Information of PR5 files, ESF files and program files, which is set to the current valid programming area, can be deleted.

<R>

Figure 4-50. [Target Setting] Area

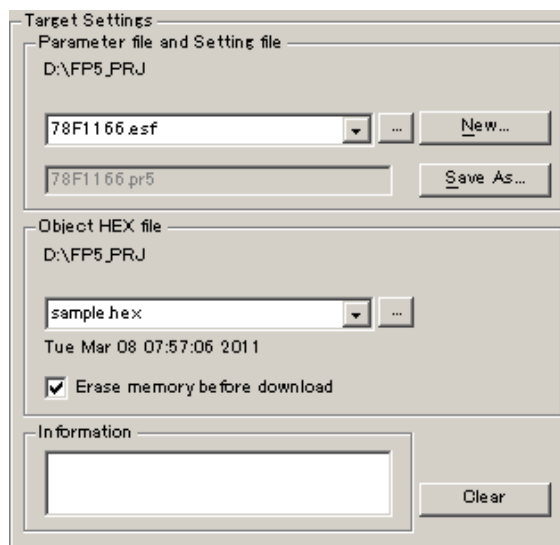

<3> [Parameter and Setting file] area

In this area, ESF files can be created and selected, and PR5 files can be selected.

<R>

Figure 4-51. [Parameter and Setting file] Area

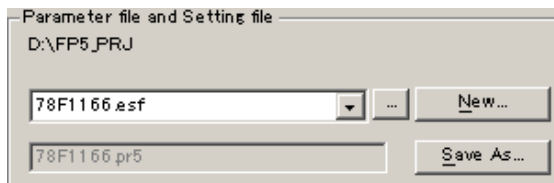

ESF file selection list box

Select the ESF file to be used. If no ESF files are registered in the valid programming area, ESF files stored in the FP5_PRJ folder in the programming GUI installation folder are displayed. If the reference folder is changed by using the [...], [New...] or [Save As...] button, ESF files stored in the changed folder are displayed.

[...] button

Click this button when specifying an ESF file stored in a folder other than the FP5_PRJ folder in the programming GUI installation folder. A dialog box for specifying the ESF file will be displayed. Specify the relevant file, and then click the [Open] button. Note that the PR5 file specified by the ESF file must be in the specified folder.

Figure 4-52. ESF File Select Dialog Box

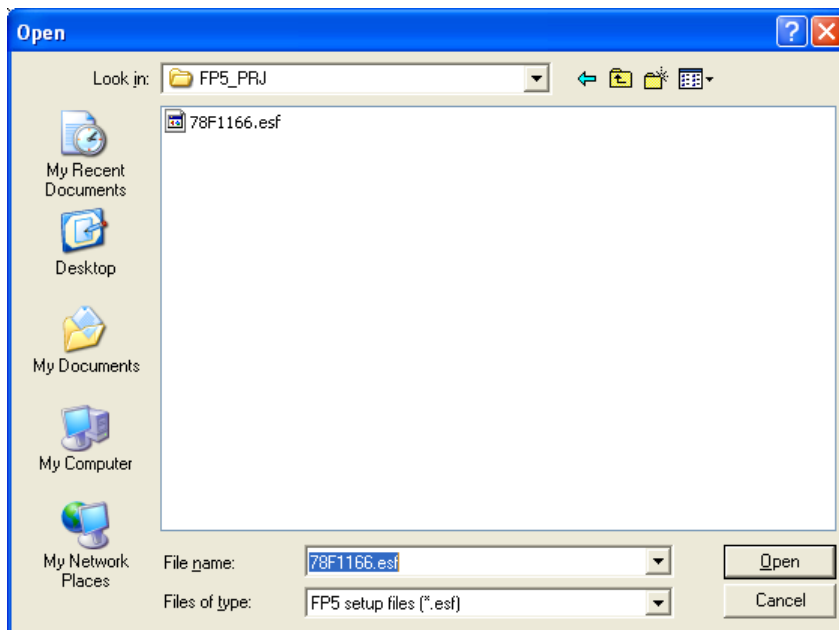

New... button

Click this button to create a new ESF file. The following dialog box will be displayed.

Figure 4-53. New ESF File Creation Dialog Box

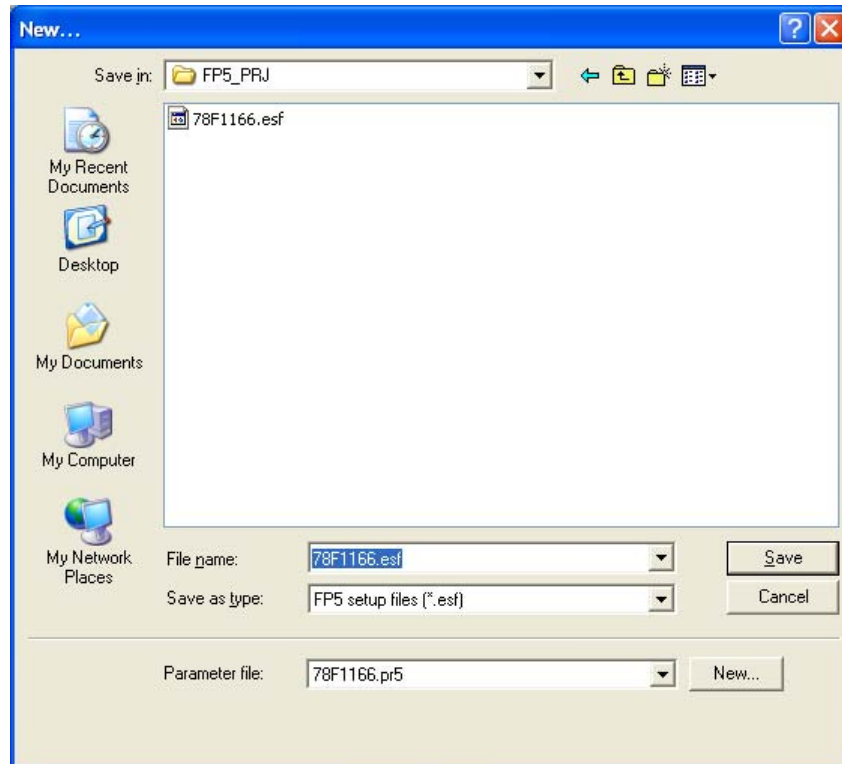

The PR5 file stored in the FP5_PRJ folder in the programming GUI installation folder is displayed in the [Parameter file:] list. Select the PR5 file for the target device used.

Clicking the **New...** button will open the following dialog box. The PR5 file can be copied to the specified folder of the ESF file with this dialog box.

Figure 4-54. [Select parameter files to copy] Dialog Box

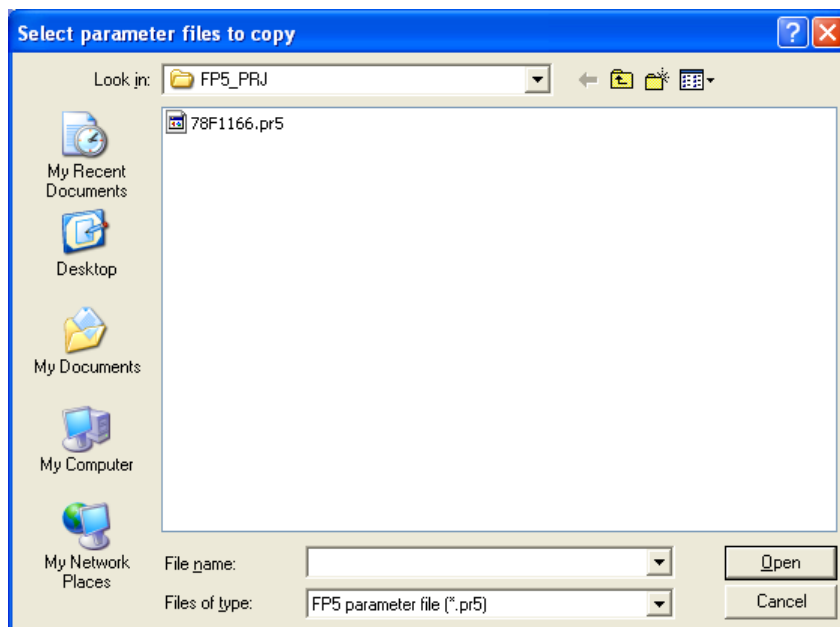

After selecting the PR5 file, input the new ESF file name and then click the **Save** button.

Save As... button

Clicking this button opens the dialog box for overwriting the current settings made in the Device Setup dialog box to the existing ESF file, or saving as another file.

Specify the file and then click the **Open** button. Note that the PR5 file is also copied to the destination folder.

Figure 4-55. [Save as...] Dialog Box

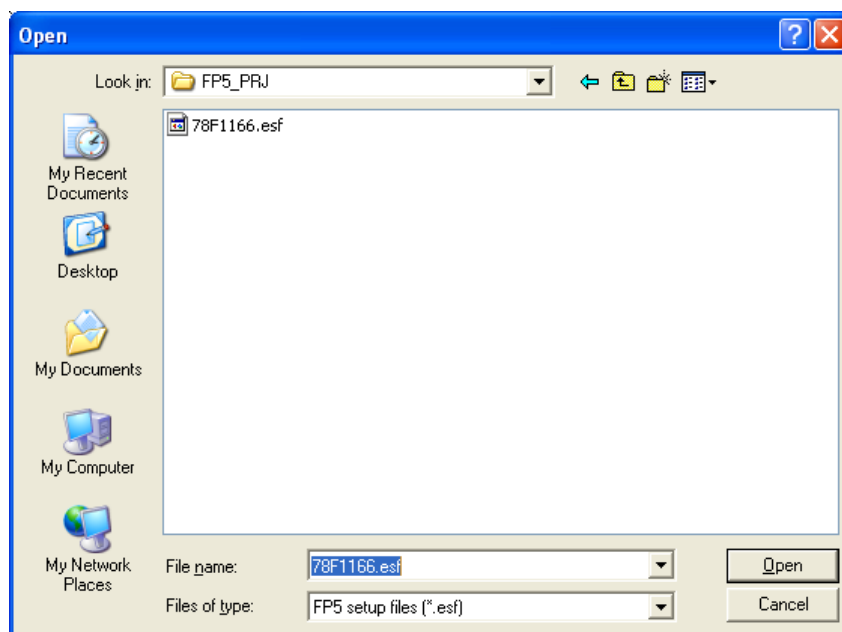

<4> [Object HEX file] area

Select the program file in this area. If an HCUHEX file is selected, "HCUHEX file" is displayed in this area.

<R>

Figure 4-56. [Object HEX file] Area

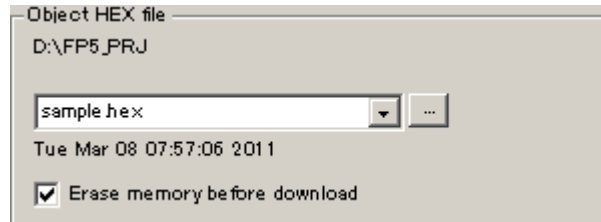

Program file selection list

Select the program file to be used. If no program files are registered in the valid programming area, program files stored in the *bin* folder in the programming GUI installation folder are displayed. If the reference folder is changed by using the [...] button, program files stored in the changed folder are displayed.

<R>

[Erase memory before download] check box

The [Erase memory before download] check box allows the user to select whether to delete the internal memory of the FP5 before downloading a new program file. Under normal conditions, check this box.

Caution Clear this check box when downloading and writing two program files. When a file is downloaded with this check box cleared, the PG-FP5 downloads data 512 bytes at a time without erasing its internal flash memory. Note, however, that the download error "ERROR: NAND flash – Illegal Write (Bit 0->1)" occurs if there is data other than FFh in the data being downloaded.

[...] button

Click this button when specifying a program file stored in a folder other than the folder in the programming GUI installation folder. The [Download file] dialog box will be displayed. Specify the relevant file, and then click the [Open] button. From the [File type (T)] list box, a program file (*.rec;*.s*;*.s2;*.mot;*.a20;*.a37;*.hex;*.ddi) or all files (*.*) can be selected.

<R>

<R>

Figure 4-57. [Download file] Dialog Box

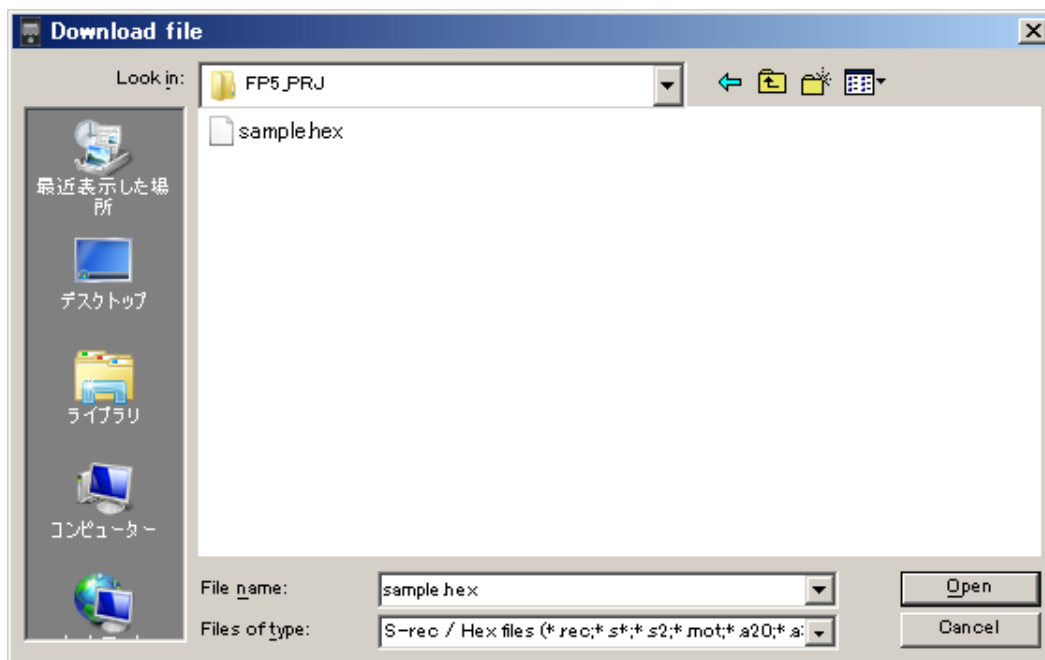

<5> [Information] area and **Clear** button

This area displays a warning message or is used to clear information on PR5 files, ESF files and program files.

Figure 4-58. [Information] Area and **Clear** Button

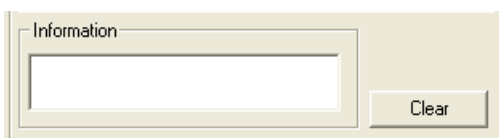

[Information] area

A warning message will be displayed in this area if there is a mismatch between PR5 files, ESF files and program files saved in the FP5 and information held in the programming GUI.

Clear button

Information of PR5 files, ESF files and program files, which is set to the current valid programming area, can be deleted .

Information of a programming area that is no longer required to be used can be deleted. When the clear button is clicked, deletion of the set information selected in the programming area settings will be specified.

When the **OK** button is clicked, programming areas that are currently valid will be downloaded and the internal memory information of the programming area, for which deletion has been specified by using the clear button, will be deleted. Deleting the information of all programming areas cannot be performed.

Initialize the FP5 management setting to initialize all programming areas. See the [FP5 Management setting (M) ...] command in 4.3.2 (9) **[FP5 Manager] command** for details.

Caution The settings are not reflected to the FP5 internal memory unless the **OK** button is clicked in the Device Setup dialog box.

<6> Programming area map area

The programming area status can be checked in this area. The FP5 programming areas whose information matches information held in the programming GUI are displayed in light green. In the valid programming area, the names of ESF files, PR5 files and program files, and programming area numbers are displayed in black. These items appear dimmed in invalid programming areas. If no area information is held in the programming GUI, "Unknown" is displayed. The FP5 programming areas whose information does not match information held in the programming GUI are displayed in pink. The information held in the programming GUI is displayed in such areas.

<R>

Figure 4-59. Programming Area Map Area

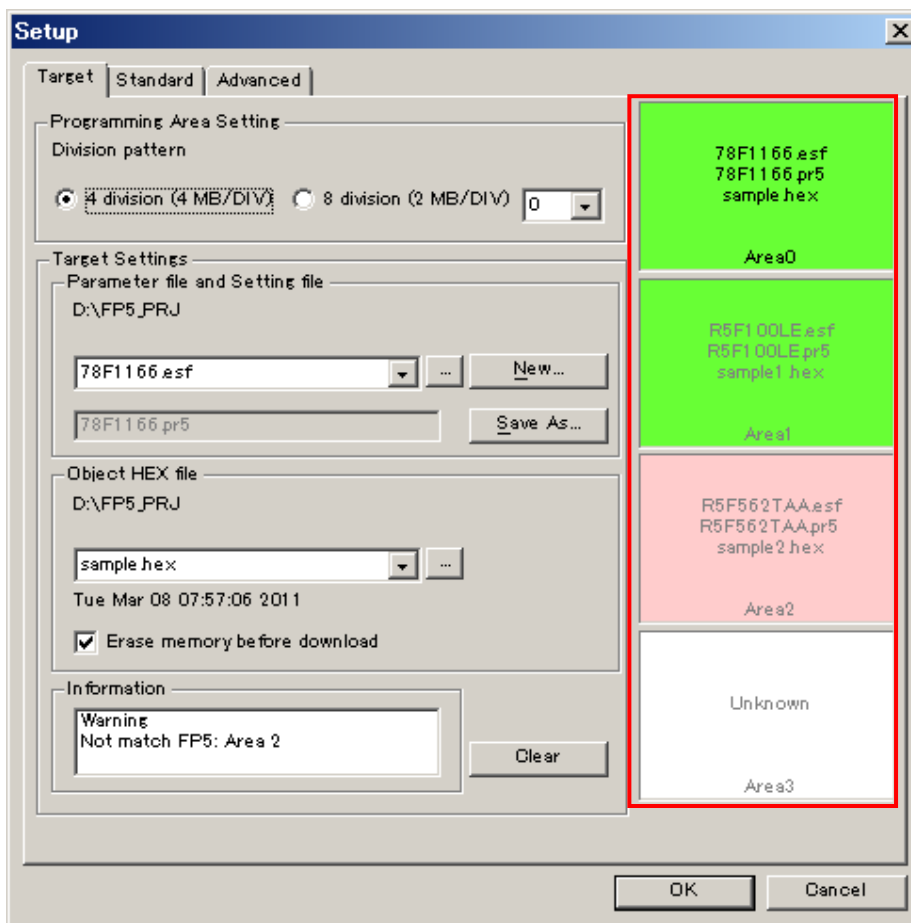

(b) [Standard] tab in Device Setup dialog box

On the [Standard] tab, set the programming environment of the flash memory in the target device. All basic settings to configure the user environment and the target device can be performed. Communication channels, speeds and the operation clock supplied to the target device vary depending on the device, so refer to the user's manual of the target device for setting these items.

This tab consists of the following items.

- <1> [Communication interface to device] area
- <2> [Supply oscillator] area
- <3> [Operation Mode] area
- <4> Defaults button

Figure 4-60. Device Setup Dialog Box - [Standard] Tab

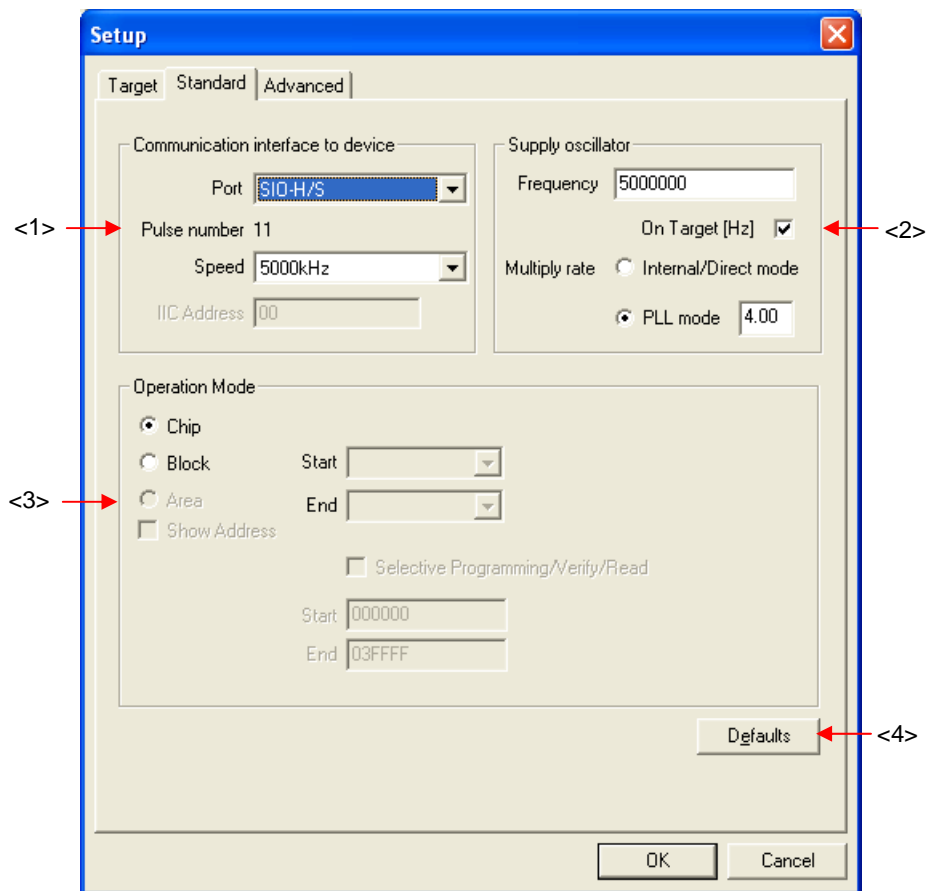

<1> [Communication interface to device] area

In this area, select the channel and speed for communication between the FP5 and target device.

Figure 4-61. [Communication interface to device] Area

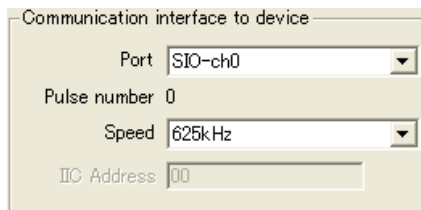

[Port] list

Select the mode of communication between the FP5 and target device. The communication mode is determined by the number of V_{PP} output from the FP5 or the FLMD0^{Note} pulse count. The selectable communication mode differs depending on the target device. Refer to the user’s manual of the target device used and select a mode. With some devices, the channel number may start from 1. In this case, the corresponding number is shifted, for example, ch0 shown in the screen corresponds to ch1 of the device, and the displayed channel number must be shifted accordingly.

Note FLMD0 in a single-power-supply flash memory microcontroller, or FLMD1 in a two-power-supply flash memory microcontroller.

Remark For the available communication channel, refer to the user’s manual of the target device, based on the pulse count displayed for “Pulse number”.

Table 4-2. Channels for Communication Between FP5 and Target Device (1/2)

Item on Screen	Description
SIO-ch0	SIO (3-wire clocked communication port) channel 0 ^{Note}
SIO-ch1	SIO (3-wire clocked communication port) channel 1
SIO-ch2	SIO (3-wire clocked communication port) channel 2
SIO-H/S	SIO (3-wire clocked communication port, with handshake pin)
IIC-ch0	I ² C channel 0
IIC-ch1	I ² C channel 1
IIC-ch2	I ² C channel 2
IIC-ch3	I ² C channel 3
UART-ch0	UART (asynchronous communication port) channel 0
UART-ch1	UART (asynchronous communication port) channel 1
UART-ch2	UART (asynchronous communication port) channel 2
UART-ch3	UART (asynchronous communication port) channel 3
Port-ch0	Port (pseudo 3-wire) A
Port-ch1	Port (pseudo 3-wire) B
Port-ch2	Port (pseudo 3-wire) C

Note This might be “3-wire clocked communication port, with handshake” depending on the target device.

<R>

Table 4-2. Channels for Communication Between FP5 and Target Device (2/2)

Item on Screen	Description
CSI-Internal-OSC	SIO (3-wire clocked communication port) (using internal oscillator) * In the case of 78K0 (All Flash)
UART- EXCLK	UART (asynchronous communication port) (using external clock/FP5 clock) *In the case of 78K0 (All Flash)
UART-X1-OSC	UART (asynchronous communication port) (using external oscillator) * In the case of 78K0 (All Flash)
UART-Internal-OSC	UART (asynchronous communication port) (using internal oscillator) * In the case of 78K0 (All Flash)
UART	Single-wire UART (asynchronous communication port) * In the case of 78K0 or 78K0R (All Flash)
UART I/O mode3	UART (asynchronous communication port) * Standard serial I/O mode 3 of the R8C family

[Pulse number]

V_{PP} or the FLMD0 count corresponding to the selected communication mode is displayed. This item cannot be changed. It is not displayed for the RX family, R8C family, and SuperH family.

<R>

[Speed] List box

Select the communication rate of the selected communication channel.

Remark For the available communication speed, refer to the user's manual of the target device. For the RX family, R8C family, and SuperH family, communication speeds that can be selected in the [Frequency] box and [PLL mode (CKP)] box are displayed in the list box.

<R>

<When UART-ch0, UART-ch1, UART-ch2, UART-ch3, UART-Ext-FP5CLK, UART-Ext-OSC, UART-Internal-OSC, or UART is selected>

- 9600 Baud
- 19200 Baud
- 31250 Baud
- 38400 Baud
- 57600 Baud
- 76800 Baud
- 115200 Baud
- 125000 Baud
- 128000 Baud
- 153600 Baud
- 250000 Baud
- 500000 Baud
- 1000000 Baud

<When SIO-ch0, SIO-ch1, SIO-ch2, SIO-H/S or CSI-Internal-OSC is selected>

- 9.8 kHz
- 39 kHz
- 156 kHz
- 625 kHz
- 2500 kHz
- 5000 kHz

<When IIC-ch0, IIC-ch1, IIC-ch2 or IIC-ch3 is selected>

- 10k Baud
- 20k Baud
- 50k Baud
- 100k Baud

<When Port-ch0, Port-ch1 or Port-ch2 is selected>

- 100 Hz
- 200 Hz
- 300 Hz
- 400 Hz
- 500 Hz
- 600 Hz
- 800 Hz
- 1000 Hz
- 1200 Hz
- 1500 Hz
- 2000 Hz

[IIC Address] area

If I²C is selected as the communication channel, input a hexadecimal number as a slave address of the target device. The valid input range is 8 to 77h. Do not input a unit. The slave address can be any value in the above range but must not be the same as the slave address of another target device on the I²C. This field is not available if the I²C port is not selected.

<2> [Supply oscillator] area

Set the clock to be supplied to the target device.

<R>

Figure 4-62. [Supply oscillator] Area

(a) When 78K, V850, RL78 Family or R8C Family Is Selected

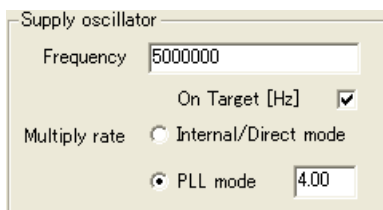

<R>

(b) When RX Family or SuperH Family Is Selected

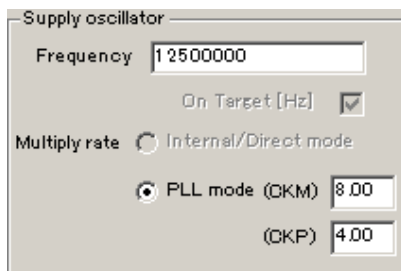

[Frequency] text box

Set the oscillation frequency of the clock supplied to the target device. When using the clock mounted on the target system ([On Target] check box selected), input its oscillation frequency. When using the clock on the FP5 side ([On Target] check box cleared), input one of the following.

- 1 MHz
- 2 MHz
- 4 MHz
- 5 MHz
- 6 MHz
- 8 MHz
- 9 MHz
- 10 MHz
- 12 MHz
- 16 MHz
- 20 MHz

Remark For the selectable frequency, refer to the user's manual for the device used.

[On Target] check box

Specify which clock is supplied to the target device: a clock mounted on the target system, or a clock on the FP5 side. If this check box is selected, the clock mounted on the target system will be used. If this check box is cleared, the clock on the FP5 side will be used.

[Multiply rate] text box

Set the multiplication ratio of the clock supplied to the target device. If the target device includes the PLL circuit, input the multiplication ratio in accordance with the environment used. If the target device does not include the PLL circuit, select "Internal/Direct mode". On the initial screen, the default settings that have been loaded from the PR5 file is displayed. For the RX family and SuperH family, the [CKM] box and [CKP] box are displayed in PLL mode. Enter the multiplication ratio of the main clock in the [CKM] box, and the multiplication ratio of the peripheral clock in the [CKP] box.

<R>

Remark For the selectable multiply rate, refer to the user's manual for the device used.

<3> [Operation Mode] area

Switch the operation mode to execute commands, such as flash memory programming, for the entire flash memory area, in area units or in block units. The settings made here are valid for the [Blank Check], [Erase], [Program], [Verify], [Read], [Checksum], and [Autoprocedure(E.P.)] commands.

<R>

Caution When loading an HCUHEX file, the HCUHEX file is handled as master data, so the [Chip] are selected. The setting of this check box therefore cannot be changed.

<R>

Figure 4-63. [Operation Mode] Area

(a) When a product without data flash is selected from the 78K, V850, RL78 family

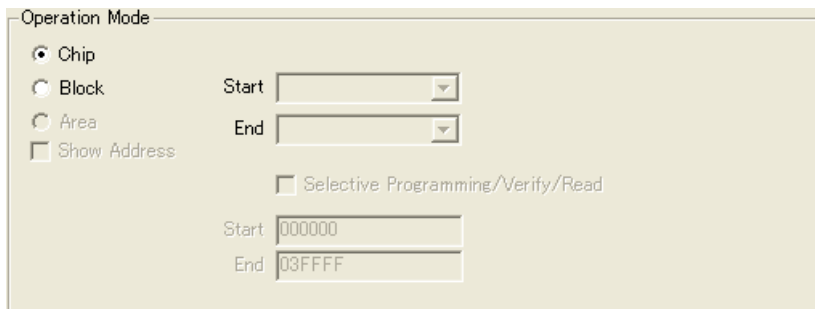

(b) When a product with data flash is selected from the 78K, V850, RL78 family

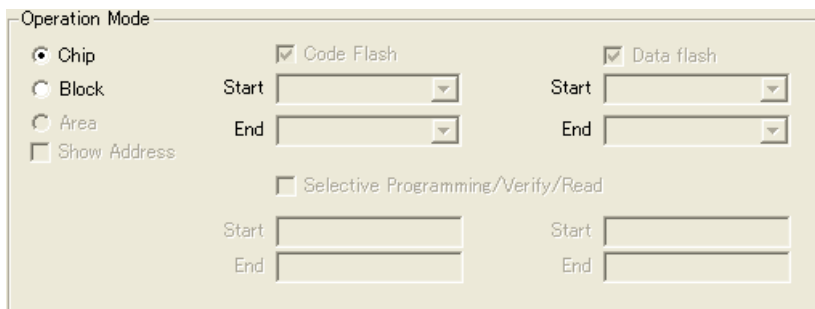

(c) When the RX family, R8C family, or SuperH family is selected

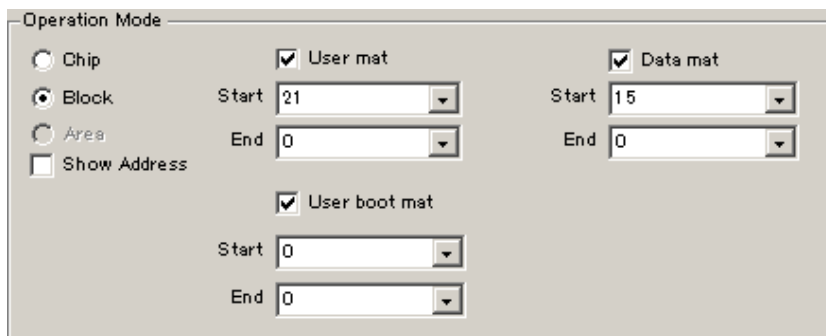

If [Chip] is selected:

The entire flash memory area of the target device is subject to command processing, such as programming.

If [Block] is selected:

Specify the block range subject to command processing, using the [Start] and [End] drop-down lists. These lists show the block numbers where flash memory in the target device is configured.

<R>

Cautions 1. For the R8C family, a block cannot be specified with the [Start/End] list box.

<R>

2. For the SuperH family, there are cautions on selection of User mat, Data mat, and User boot depending on the format of the program file.

Other than DDI files: If the addresses of User mat, Data mat, and User boot overlap, multiple items cannot be selected.

DDI files: The restriction above does not exist.

If [Area] is selected:

Specify the Area number range subject to rewrite processing by using the [Start] and [End] lists.

The [Start/End] lists display the Area number where the target device is configured.

[Show Address] check box

Specifies whether numbers or addresses are displayed in the Start/End lists. If this check box is checked, addresses are displayed. If it is not checked, numbers are displayed.

[Selective programming/Verify/Read] check box

This item is not available.

<4> **Defaults** button

The default settings stored in the PR5 file are restored.

(c) [Advanced] tab in Device Setup dialog box

On the [Advanced] tab, the programming voltage, options added to programming commands, and security settings can be configured. This tab consists of the following items.

- <1> [Supply voltage] area
- <2> [Command options] area
- <3> [Flash options] area
- <4> [Set Security command options] area
- <5> [Security flag settings] area
- <6> [Block protection settings] area
- <7> [Reset vector setting] area
- <8> [OCD security ID setting] area
- <9> [Option bytes setting] area
- <R> <10> [Lock bit setting] area
- <R> <11> [I/O signal setting] area
- <R> <12> [ID code] area

Figure 4-64. Device Setup Dialog Box - [Advanced] Tab (1/2)

<R> (a) When 78K, V850 or RL78 Family Is Selected

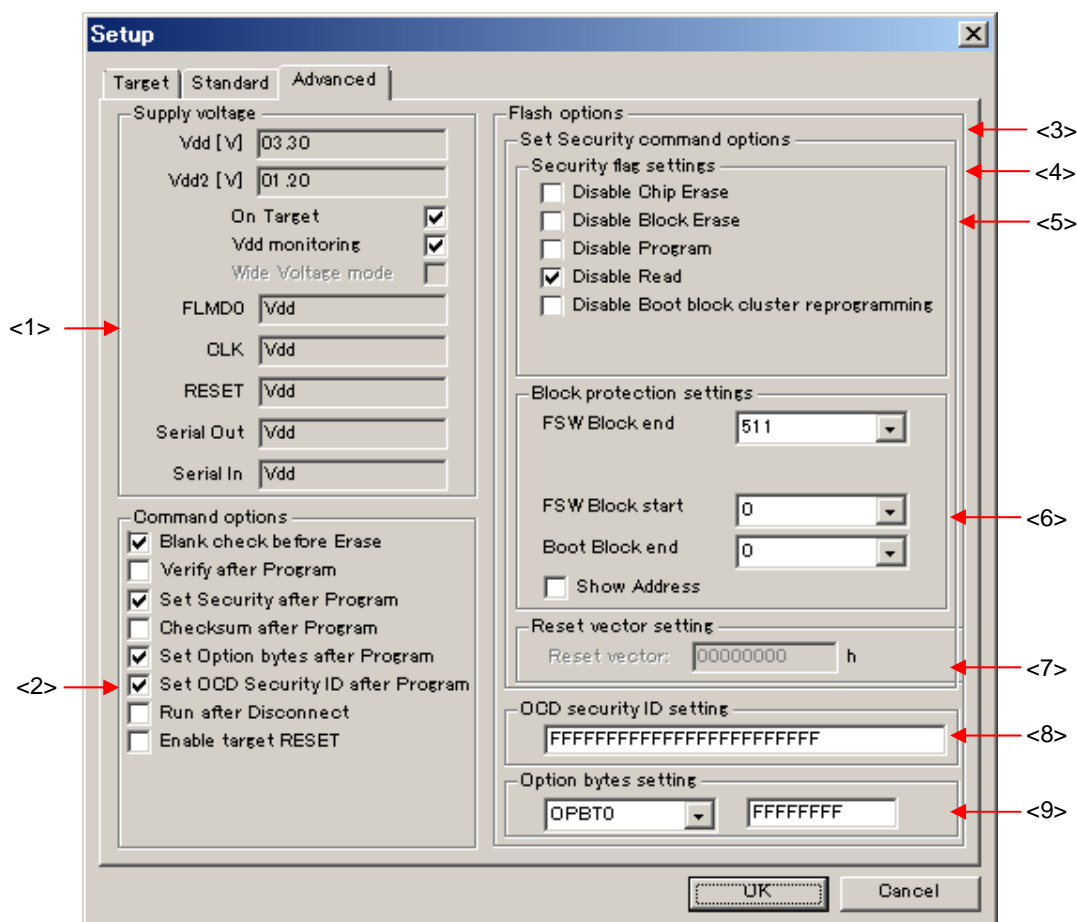
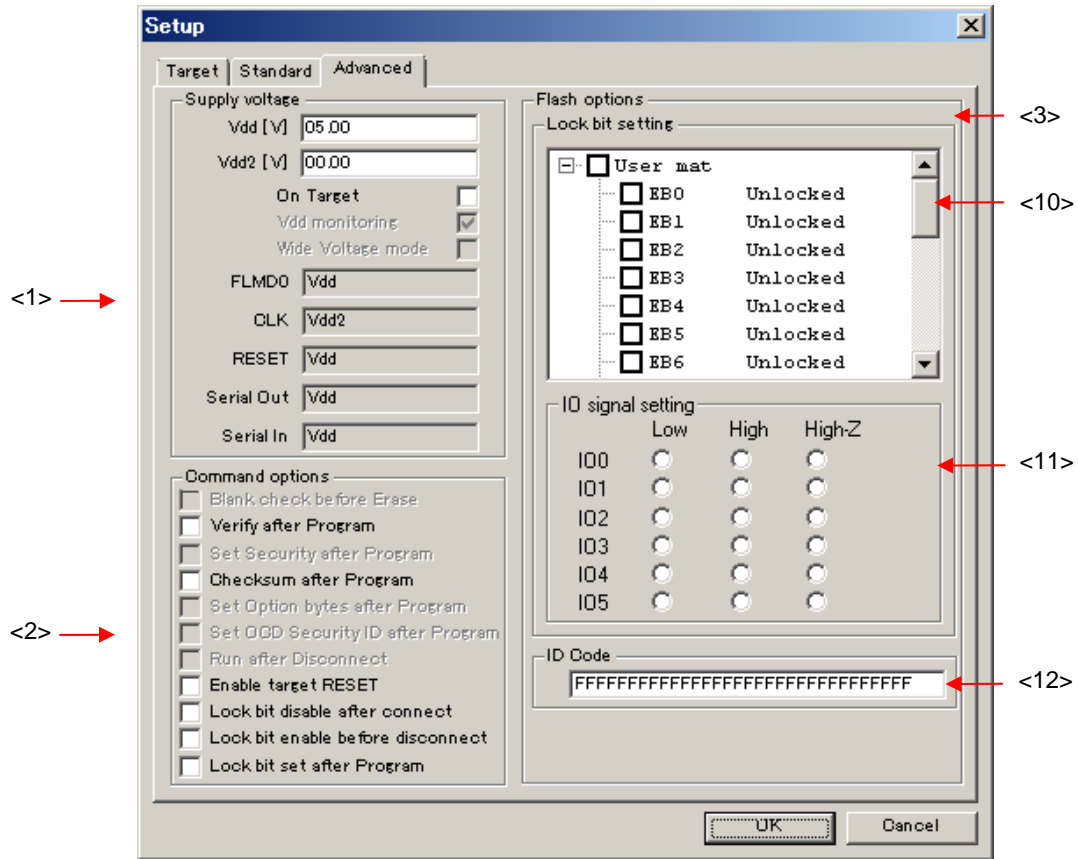

Figure 4-64. Device Setup Dialog Box - [Advanced] Tab (2/2)

<R>

(b) When RX Family R8C Family or SuperH Family Is Selected



<1> [Supply voltage] area

In this area, specify one (V_{DD}) or two (V_{DD} and V_{DD2}) voltage levels for target device programming, in accordance with the target device type. Basically, V_{DD}/V_{DD2} voltages for target device programming should be supplied from the target system. Supplying from the FP5 is possible, but the current flow is not large enough to operate the whole target system (Refer to **APPENDIX C ELECTRICAL SPECIFICATIONS OF TARGET INTERFACE**). Therefore, supply voltage via the FP5 only when a dedicated writing adapter such as an FA adapter is used.

Figure 4-65. [Supply voltage] Area

[Vdd[V]] box

The default V_{DD} level set in the PR5 file is displayed in volts (V). This level can be changed by input.

[Vdd2[V]] box

The default V_{DD2} level set in the PR5 file is displayed in volts (V). If the target device specifications require two types of V_{DD} for writing to flash memory, specify a lower voltage for V_{DD2} (e.g. $V_{DD} = 5.0$ V, $V_{DD2} = 3.3$ V). This level can also be changed by input.

[On Target] check box

Select this check box when supplying the V_{DD}/V_{DD2} voltages from the target system.

Caution Set the values of the V_{DD}/V_{DD2} voltages supplied from the target system for Vdd [V] and Vdd2 [V] before selecting this check box. The target system may be damaged if proper values are not set.

The V_{DD} pin power supply detection function varies depending on the setting of the [On Target] check box.

- When V_{DD} is set to be supplied from FP5 ([On Target] check box: not selected)
If the target system V_{DD} exceeds 0.2 V before V_{DD} is supplied, the message “Target power detected! Check Setup” will be displayed in the action log window.
- When V_{DD} is set to be supplied from the target system ([On Target] check box: selected)
If V_{DD} is outside the range of $\pm 5\%$ of the V_{DD} set value immediately before communication starts, the message “No VDD applied or Voltage is out of range” will be displayed in the action log window.

[Vdd monitoring] check box

When supplying V_{DD} from the target system ([On Target] check box: selected), whether to enable the V_{DD} pin power supply detection function can be selected with this check box. Select to enable, or clear to disable the function.

Caution When the V_{DD} pin power supply detection function is disabled, the product can be used even if the V_{DD} pins in the FP5 and the target system are not connected. In such a case, make sure that V_{DD} power generated in the target system always matches the output signal power supply generated in the FP5.

[Wide Voltage mode] check box

This check box can be used to select whether to use wide-voltage mode or full-speed mode. If this check box is checked, commands are executed in wide-voltage mode. If this check box is not checked, commands are executed in full-speed mode. This check box becomes available when a device that supports this function is selected. For details about wide-voltage mode and full-speed mode, see the user's manual of the target device.

Caution When loading an HCUHEX file, the HCUHEX file is handled as master data, so the HCUHEX file settings are applied to the target device. The setting of this check box therefore cannot be changed.

[FLMD0] (or V_{pp}[V]), [CLK], [RESET], [Serial Out] and [Serial In] boxes

Through the PR5 file, this box displays the various default terminal levels. FLMD0 (or V_{pp}[V]) uses volt (V) units, CLK uses V_{dd} or V_{dd2}, RESET uses V_{dd} or VDD Reset TrigIn, and Serial Out and Serial In use V_{dd}. Note that VDD Reset TrigIn is displayed when the [Enable target RESET] check box of the [Command options] area is enabled.

<2> [Command options] area
 In this area, set options to be added to the [Erase], [Program] and [Autoprocedure(E.P.)] commands.

<R> **Caution** When loading an HCUHEX file, the HCUHEX file is handled as master data. The settings of [Blank check before Erase], [Set Security after Program] becomes enabled and they cannot be changed. Also, [Set Option bytes after Program], and [Set OCD Security ID after Program] cannot be changed.

<R> **Figure 4-66. [Command options] Area**

(a) When the 78K, V850, or RL78 family is selected (b) When the RX family, R8C family, or SuperH family is selected

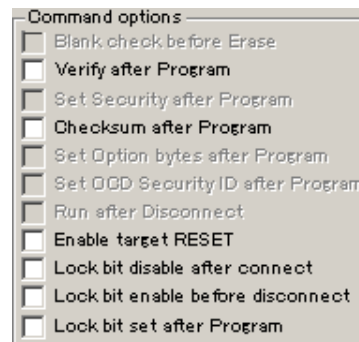
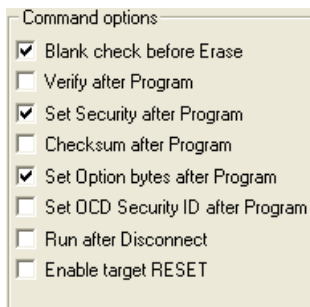

[Blank check before Erase] check box

If this check box is selected, the [Blank Check] command is automatically executed before the [Erase] and [Autoprocedure(E.P.)] commands are executed.

[Verify after Program] check box

If this check box is selected, the [Verify] command is automatically executed after the [Program] and [Autoprocedure(E.P.)] commands are executed.

[Set Security after Program] check box

If this check box is selected, the [Set Security] command is automatically executed after the [Program] and [Autoprocedure(E.P.)] commands are executed.

[Checksum after Program] check box

If this check box is selected, the [Checksum] command is automatically executed after the [Program] and [Autoprocedure(E.P.)] commands are executed.

[Set Option bytes after Program] check box

If this check box is selected, the [Set Option bytes] command is automatically executed after the [Program] and [Autoprocedure(E.P.)] commands are executed.

[Set OCD security ID after Program] check box

If this check box is selected, the [Set OCD Security ID] command is automatically executed after the [Program] and [Autoprocedure(E.P.)] commands are executed.

[Run after Disconnect] check box

If this check box is selected, the $\overline{\text{RESET}}$ signal level changes from low level to Hi-Z after each command. Note that when the “Reset option of Run after Disconnect” is set to Pull-up with the [FP5 Manager] dialog box, the signal will go from low level to Pull-up. If this check box is not selected, the $\overline{\text{RESET}}$ signal changes to low level after each command is finished. This check box becomes available if the [On Target] check box in the [Supply voltage] area is selected. If selected, the written program can be automatically executed after each command is finished.

[Enable target Reset] check box

When this box is checked, the $\overline{\text{RESET}}$ terminal will change to the input mode (Hi-Z). Immediately after execution of the various commands, FP5 will detect the leading edge of the signal entering the $\overline{\text{RESET}}$ terminal. Until a signal is detected, “Waiting for RESET...” will be displayed in the action log window, and the transition to the flash memory programming mode will be put on hold. When the signal is detected, the transition will be resumed. And right before each commands are completed, FP5 will detect the leading edge of the signal entering the $\overline{\text{RESET}}$ terminal. Until a signal is detected, “Waiting for RESET” will be displayed in the action log window, and the termination of the flash memory programming mode will be put on hold. When the signal is detected, the flash programming mode is ended.

Figure 4-67 Detection Timing of Target Reset

(a) Transition to the flash memory programming mode

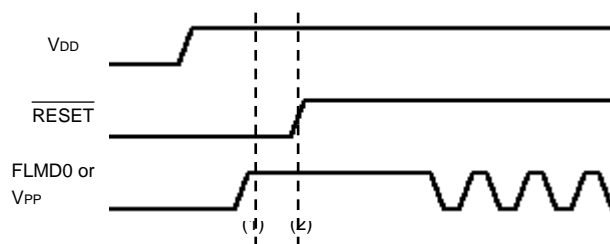

- (1): Put the transition to the flash memory programming mode on hold.
- (2): Detect the rising edge of the signal entering the $\overline{\text{RESET}}$ pin.

(b) Ending the flash memory programming mode

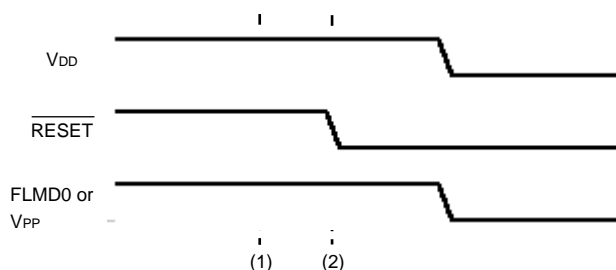

- (1): Put the ending of the flash memory programming mode on hold.
- (2): Detect the falling edge of the signal entering the $\overline{\text{RESET}}$ pin.

<R> [Lock bit disable after connect] check box
If this check box is selected, the command is executed, and the lock bit is disabled after connection with the microcontroller.

[Lock bit enable before disconnect] check box
If this check box is selected, the command is executed, and the lock bit is enabled after disconnection from the microcontroller.

[Lock bit set after Program] check box
If this check box is selected, the [Set Lock bit] command is executed when the [Program] command is finished.

Remark For details of lock bits, refer to the user's manual of the target device.

<3> [Flash options] area

<R> For the 78K, V850, and RL78 family, setting of the Set Security command options (security flag settings, block protection settings, reset vector handling function setting, on-chip debug security ID setting, and option byte setting) can be performed in this area. For the RX family, R8C family, and SuperH family, lock bit setting, I/O signal setting, and ID code can be set. When the [Get Flash options] command is enabled, settings in this area can be confirmed by running the [Get Flash options] command before running the [Set Security] command, [Set OCD Security ID] command, or [Set Option bytes] command.

Cautions 1. For setting of the flash options (security flag settings, block protection settings, reset vector handling function setting, on-chip debug security ID setting, and option byte setting), lock bit, and ID code, refer to the user’s manual of the target device.

2. When loading an HCUHEX file, the HCUHEX file is handled as master data, so the HCUHEX file settings are applied to the target device. The setting of this check box therefore cannot be changed.

Figure 4-68. [Flash options] Area

(a) When the 78K, V850, or RL78 family is selected (b) When the RX family, R8C family, or SuperH family is selected

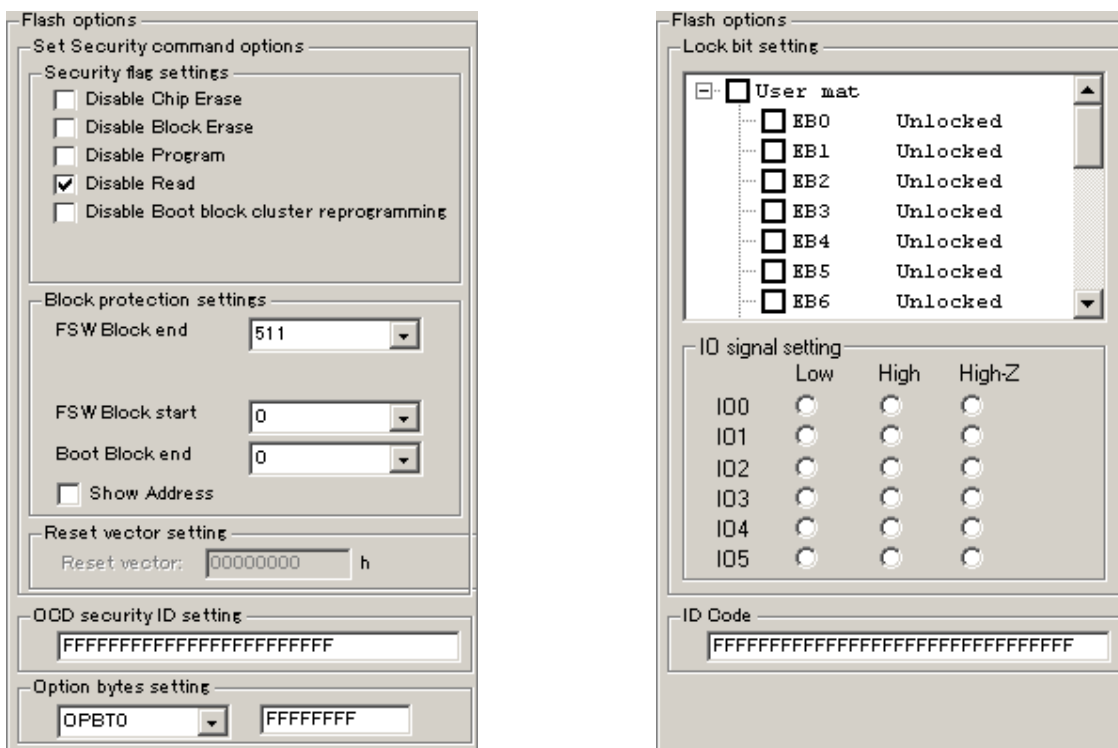

<4> [Set Security command options] area

The security flag settings block protection settings, and reset vector handling function setting can be set in this area. When the [Set Security] command is executed, the settings in this area will be reflected in the target device.

<R>

Figure 4-69. [Security flag settings] Area

Set Security command options

Security flag settings

- Disable Chip Erase
- Disable Block Erase
- Disable Program
- Disable Read
- Disable Boot block cluster reprogramming

Block protection settings

FSW Block end: 511

FSW Block start: 0

Boot Block end: 0

Show Address

Reset vector setting

Reset vector: 00000000 h

<5> [Security flag settings] area
 The security flag settings can be selected in this area.

<R>

Figure 4-70. [Security flag settings] Area

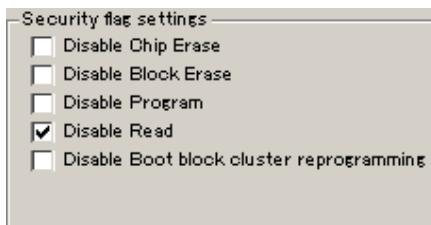

[Disable Chip Erase] check box

If the [Set Security] command is executed with this check box selected, the [Erase] command will be disabled for the entire area of the flash memory in the target device. When this check box is selected, the following dialog box appears.

Figure 4-71. [Disable Chip Erase] Warning Dialog Box

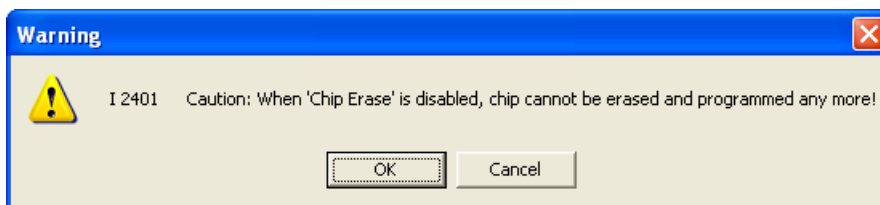

Clicking the [OK] button determines the selection of the [Disable Chip Erase] check box.
 Clicking the [Cancel] button cancels the selection of the [Disable Chip Erase] check box.

Caution If the [Disable Chip Erase] function is enabled, erasure for the device will no longer be possible, and the [Disable Chip Erase] function will no longer be able to be disabled.

[Disable Block Erase] check box

If the [Set Security] command is executed with this check box selected, the [Erase] command is disabled for all the selected blocks in the flash memory selected with “Block” in the [Operation Mode] area on the [Standard] tab in the Device Setup dialog box. This setting is cleared if the [Erase] command is executed with “Chip” selected in the [Operation Mode] area. If this is selected when the RL78 family is selected, the following dialog box is displayed.

<R>

<R>

Figure 4-72. [Block Erasure Prohibition] Warning Dialog Box

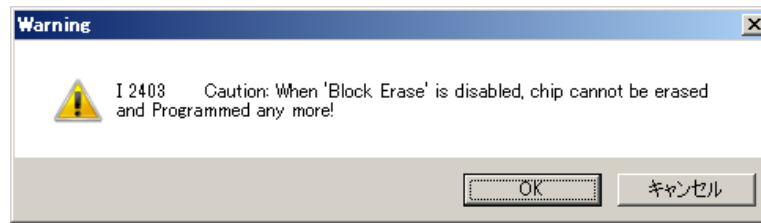

[Disable Program] check box

If the [Set Security] command is executed with this check box selected, the [Erase] command for all the selected blocks in the flash memory selected with “Block” in the [Operation Mode] area on the [Standard] tab in the Device Setup dialog box and the [Program] command is disabled. This setting is cleared if the [Erase] command is executed with “Chip” selected in the [Operation Mode] area.

[Disable Read] check box

If the [Set Security] command is executed with this check box selected, the [Read] command is disabled. This setting is cleared if the [Erase] command is executed with “Chip” selected in the [Operation Mode] area.

[Disable Boot block cluster reprogramming] check box

If the [Set Security] command is executed with this check box selected, the boot block set in the [Boot Block end] drop-down list is regarded as the last block in the [Block protection settings] area and then the boot area is set, and rewriting to the area is prohibited. If this check box is selected, the following dialog box appears.

Figure 4-73. [Disable Boot block cluster reprogramming] Warning Dialog Box

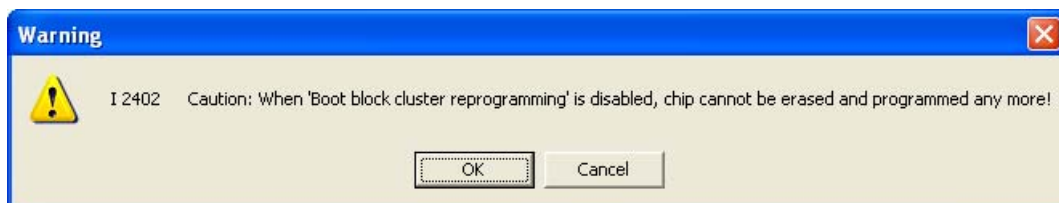

Clicking the **OK** button determines the selection of the [Disable Boot block cluster reprogramming] check box.

Clicking the **Cancel** button cancels the selection of the [Disable Boot block cluster reprogramming] check box.

Caution If the [Disable Boot block cluster reprogramming] function is enabled, rewriting of the boot area and execution of the [Erase] command with “Chip” selected in the [Operation Mode] area will no longer be possible for the device, and the [Disable Boot block cluster reprogramming] function will no longer be able to be disabled.

<6> [Block protection settings] area

In this area, block settings when the [Disable Boot block cluster reprogramming] check box is selected and block settings for the flash shield window function can be performed.

Figure 4-74. [Block protection settings] Area

[Boot Block end] drop-down list

Select a block number from this list if the [Disable Boot block cluster reprogramming] check box is selected. This list shows the block numbers where the flash memory in the target device is configured. [Refer to the user's manual of each target device for the setting method.](#)

[FSW Block start] and [FSW Block end] drop-down lists

Select the block subject to the flash shield window function, using these lists. Only the specified range can be written through flash memory self programming. This setting does not affect programming using the programmer. This function can prevent areas out of the specified range from being written to by mistake during flash self programming. These lists show the block numbers where the flash memory in the target device is configured. Refer to the user's manual of each target device for the setting method.

[Show Address] check box

Specify the display format in the [Boot Block end], [FSW Block start] and [FSW Block end] drop-down lists. If this check box is selected, the block address is displayed. If this check box is cleared, the block number is displayed.

<7> [Reset vector setting] area

The reset vector handling function can be set in this area.

Figure 4-75. [Reset vector setting] Area

[Reset vector] text box

If the [Set Security] command is executed with an arbitrary address value input, the reset vector is changed to the specified address. This setting is cleared if the [Erase] command is executed with "Chip" selected in the [Operation Mode] area.

<8> [OCD security ID setting] area

The OCD security ID can be set in this area. When the [Set OCD Security ID] command is executed, the settings in this area will be reflected in the target device.

Figure 4-76. [OCD security ID setting] Area



[OCD security ID setting] text box

If the [Set OCD Security ID] command is executed after entering an on-chip debug security ID in this box, the on-chip debug security ID is set. This setting is cleared if the [Erase] command is executed with "Chip" selected in the [Operation Mode] area.

<9> [Option bytes setting] area

The option bytes can be set in this area. When the [Set Option bytes] command is executed, the settings made in this area in the Device Setup dialog box will be reflected in the target device.

Figure 4-77. [Option bytes setting] Area

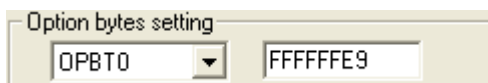

[Option byte setting] text box

If the [Set Option bytes] command is executed after entering a setting value of option byte (OPBTx (x = 0 to 8)) in 8-byte unit, the option bytes are set. This setting is cleared if the [Erase] command is executed with "Chip" selected in the [Operation Mode] area.

<R> <10> [Lock bit setting] area

Whether to set lock bits in units of blocks can be selected for User mat. It is locked when this check box is selected, or unlocked when it is cleared. For details on lock bits, refer to the user's manual of the target device.

Figure 4-78. [Lock bit setting] area

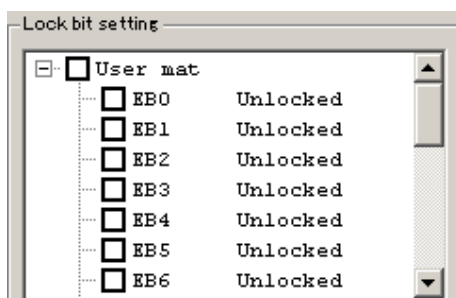

<R> <11> [IO signal setting] area

A pin to control the mode pins (MD0 and MD1) of the RX family and SuperH family can be selected from the IO0 to IO5 pins. For details, refer to **CHAPTER 10 NOTES ON TARGET SYSTEM DESIGN**.

Figure 4-79. [IO signal setting] area

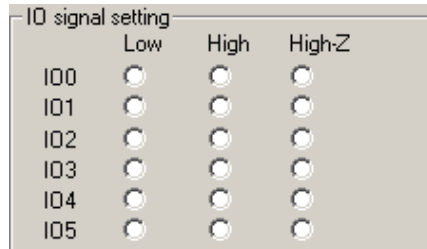

<R> <12> [ID code] area

For the RX family, R8C family, and SuperH family, ID code authentication is performed before each command is executed. Enter an ID code in the [ID code] area. For the RX family and SuperH family, the FP5 automatically repeats it three times (the flash memory in the microcontroller is erased depending on the setting). For the R8C family, it is performed only once. For details on ID code, refer to the user's manual of the target device.

Figure 4-80. [ID code] area



4.3.4 [Help] menu

Clicking the [Help] menu displays the following pull-down menu.

<R>

Figure 4-81. [Help] Menu

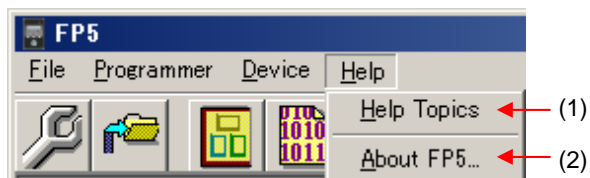

(1) [Help Topics] command

The [Help Topics] command opens the FP5 help file.

(2) [About FP5] command

This command opens the following dialog box and shows the versions of the programming GUI.

Clicking the button closes this dialog box.

<R>





Figure 4-82. [About FP5] Dialog Box



4.4 Toolbar

The commands frequently used with the programming GUI are displayed as buttons on the toolbar. A command can be executed just by clicking the relevant button. Some commands may be unavailable depending on the PR5 file selected, or when the programming GUI is started for the first time. Also, if an HCUHEX file is selected, the HCUHEX file is handled as master data, so the [Program], [Read], and [Set Security] commands are unavailable. By pointing to a button with the pointer, the hint for the button is displayed on the hint bar.

Table 4-3. Toolbar Buttons

	<p>Opens the Device Setup dialog box.</p> <p>This performs the same action as selecting the [Setup] command in the [Device] menu.</p>
	<p>Opens the File Upload dialog box.</p> <p>This performs the same action as selecting the [Upload from FP5...] command in the [File] menu</p>
	<p>Opens the programming area select dialog box.</p> <p>This performs the same action as selecting the [Select Programming area...] command in the [Programmer] menu.</p>
	<p>Opens the HEX Editor select dialog box.</p> <p>This performs the same action as selecting the [HEX Editor...] command in the [File] menu.</p>
	<p>Executes the con command or dcon command.</p> <p>This performs the same action as selecting the [Connect] command in the [Device] menu.</p>
	<p>Executes the [Blank Check] command.</p> <p>This performs the same action as selecting the [Blank Check] command in the [Device] menu.</p>
	<p>Executes the [Erase] command.</p> <p>This performs the same action as selecting the [Erase] command in the [Device] menu.</p>
	<p>Executes the [Program] command.</p> <p>This performs the same action as selecting the [Program] command in the [Device] menu.</p>
	<p>Executes the [Verify] command.</p> <p>This performs the same action as selecting the [Verify] command in the [Device] menu.</p>
	<p>Executes the [Set Security] command.</p> <p>This performs the same action as selecting the [Set Security] command in the [Device] menu.</p>
	<p>Executes the [Autoprocedure(E.P.)] command.</p> <p>This performs the same action as selecting the [Autoprocedure(E.P.)] command in the [Device] menu.</p>

4.5 Action Log Window

This window displays the log of programming GUI actions.

Figure 4-83. Action Log Window

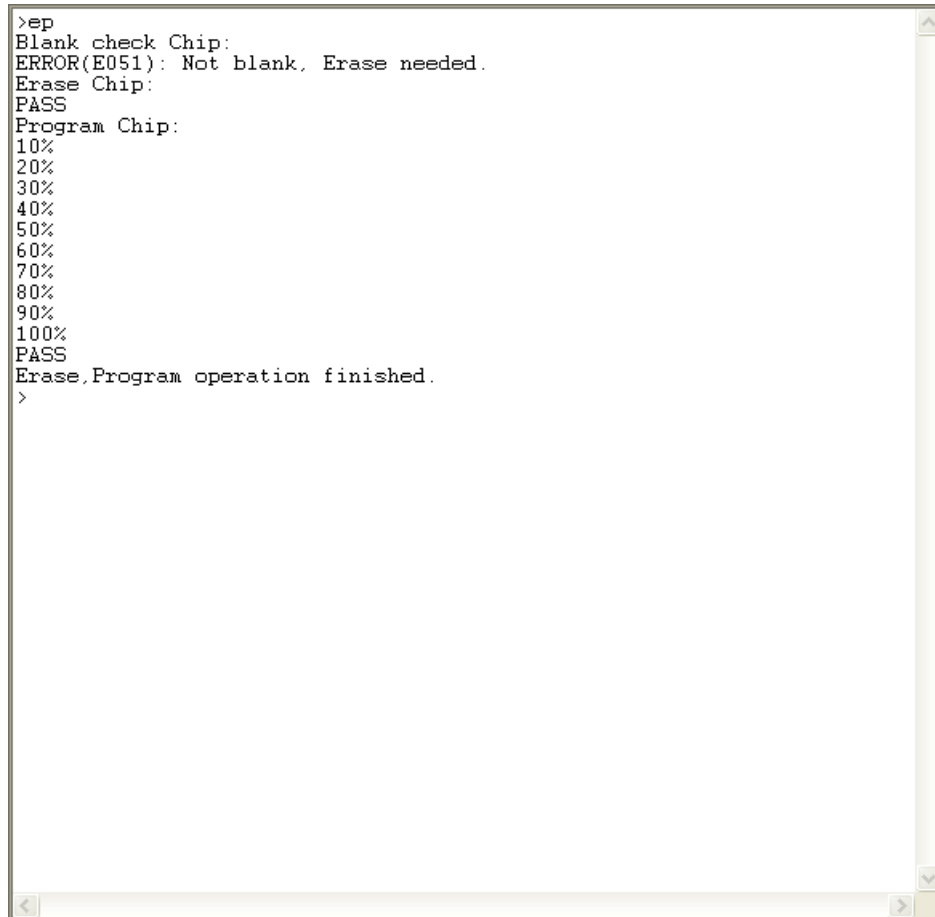

```
>ep
Blank check Chip:
ERROR(E051): Not blank, Erase needed.
Erase Chip:
PASS
Program Chip:
10%
20%
30%
40%
50%
60%
70%
80%
90%
100%
PASS
Erase,Program operation finished.
>
```

4.6 Programming Parameter Window

This window displays the programming parameter settings.

<R>

Figure 4-84. Programming Parameter Window

Programmer	
FP5 GUI:	V2.07
Firmware:	V2.07
Prog Area:	0
Mode:	Standard mode unsecured
Parameter and Setting file	
Name:	78F1166.pr5
Version:	V1.00
Name:	78F1166.esf
Date:	Wed Dec 07 20:57:31 2011
Download file	
Name:	sample.hex
Date:	Tue Mar 8 07:57:00 2011
Type:	HEX file
Address:	00000000-0003FFFF
File checksum	
Type:	Arithmetic checksum (16 bit)
Address:	00000000-0003FFFF
Value:	2A8E
Target device	
Name:	78F1166
Port:	UART
Pulse Num:	0
Speed:	1 000 000 bps
Vdd:	05.00 V (FP5)
Freq:	Internal Osc (Target)
Multiply:	1.00
Mode:	Chip
Range:	-----

[Programmer] area

Displays information such as the programming GUI version, FP5 firmware version, valid programming area number, and FP5 mode.

[Parameter and Setting file] area

Displays information such as the PR5 file name and its version, and the ESF file name and date set in the valid setting programming area.

[Download file] area

Displays information such as the file name, date, type, and start and end addresses of the program file set in the valid setting programming area. If an HCUHEX file is selected, "HCUHEX file" is displayed in "Type". If an HEX file without option data is selected, "HEX file" is displayed in "Type".

[File checksum] area

Displays the checksum result for execution of the [Checksum...] command in the [File] menu.

[Target device] area

Displays information of the settings on the [Standard] tab in the Device Setup dialog box. This area is updated after the button in the Device Setup dialog box is clicked and files are downloaded.





4.7 Status Bar

The status bar shows the progress as a color or with a message when a PR5 file, ESF file or program file is selected, or when a command is executed for the target device.

Figure 4-85. Status Bar

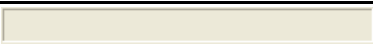

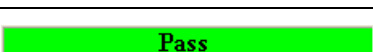
Table 4-4. Status Bar Displays

	Immediately after the programming GUI is started
	A command execution is in progress, or a PR5 file, ESF file or program file is being downloaded
	A command execution or downloading of a PR5 file, ESF file or program file is completed normally
	A command execution or downloading of a PR5 file, ESF file or program file is terminated abnormal

4.8 Hint Bar

By pointing to a command on the menu bar or a button with the pointer, the hint for the command or button is displayed on the hint bar.

<R>

Figure 4-86. Hint Bar

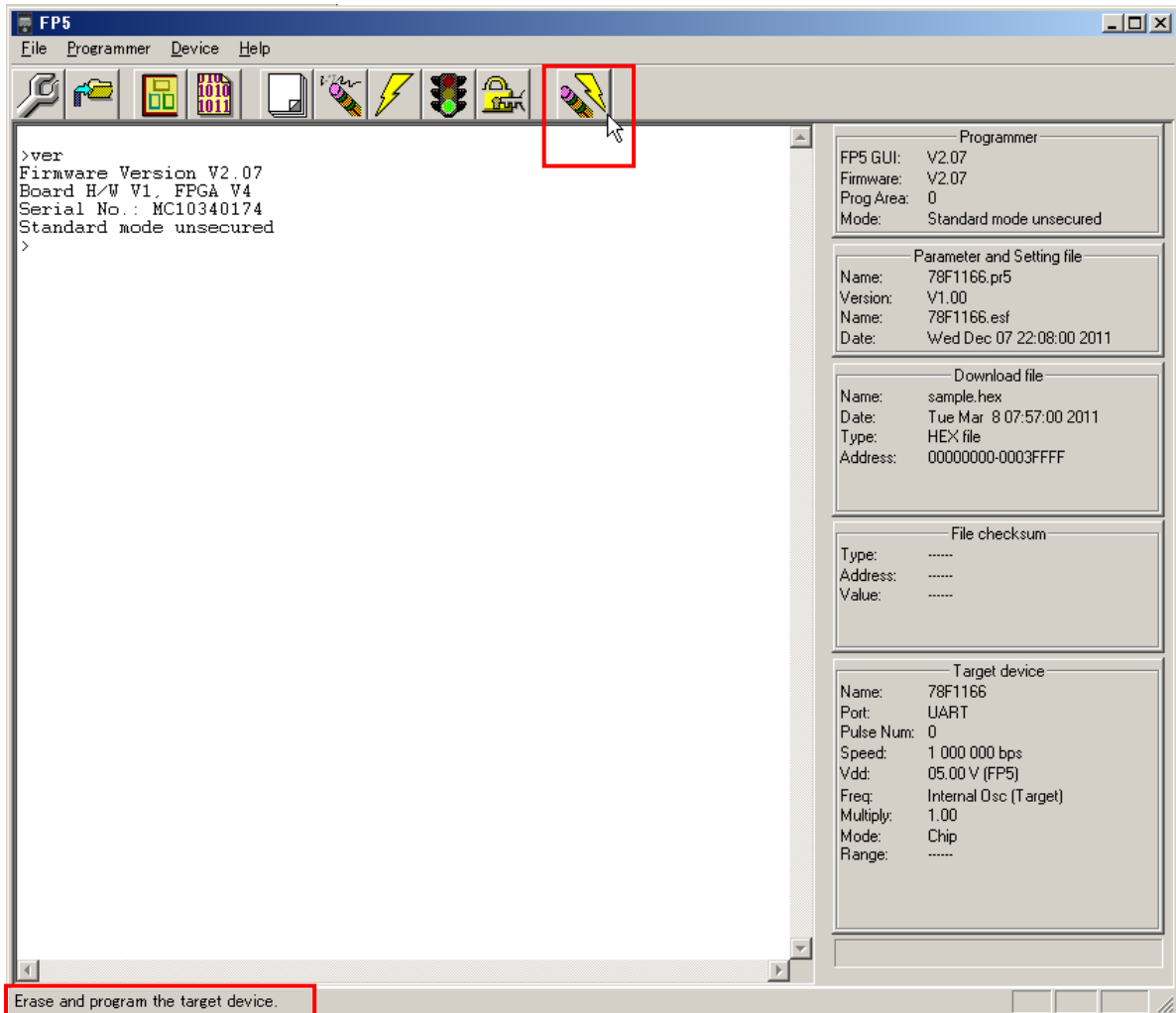

CHAPTER 5 EXAMPLE OF OPERATION USING PROGRAMMING GUI

This chapter explains a series of basic FP5 operations using the programming GUI, taking a case where the μ PD78F1166 is used as the target device as an example. This chapter covers how to start the system, execute the [Autoprocedure(E.P.)] command and program the target device.

- Series of operations described in this chapter:

The operation conditions for this chapter are as follows.

Host machine interface:	USB
Programming area:	Divided by 4, Area 0
Target device:	μ PD78F1166 (with program adapter)
Communication channel:	UART @ 1 MHz
Clock setting:	None (Internal OSC) Internal/Direct mode
Operation mode:	Chip
Supply voltage:	Supplied from FP5 (5 V)
Command option:	[Blank check before Erase] enabled
Flash option:	Not used

The operation steps described in this chapter are as follows

- (1) Installation of programming GUI
- (2) Installation of PR5 file
- (3) System connection and installation of USB driver
- (4) Connection of program adapter
- (5) Startup of programming GUI
- (6) Setting of programming environment
- (7) Execution of [Autoprocedure(E.P.)] command
- (8) System shutdown

(1) Installation of programming GUI and USB driver

<R> Refer to **CHAPTER 3 SOFTWARE INSTALLATION** and install the programming GUI and USB driver in the host machine (if it has not been installed yet).

(2) Installation of PR5 file

Refer to **CHAPTER 3 SOFTWARE INSTALLATION**, download the PR5 file for the μ PD78F1166 and copy it to the FP5_PRJ folder in the programming GUI installation folder.

<R> (3) System connection and installation of USB driver

- <1> Connect the USB connector of the FP5 to the USB port on the host machine using a USB cable.
- <2> Plug the FP5 power supply connector into the AC outlet (100 to 240 V) using the AC adapter.
- <3> Press the **POWER** button on the FP5 to turn on power. Do not connect the program adapter (target device) before turning on power. Confirm that the POWER LED on the FP5 is off and that 'Commands >' is displayed in the message display, indicating that the FP5 is ready for operation. If not, the cause may be a defect in the FP5, so consult a Renesas Electronics sales representative or distributor.

(4) Connection of program adapter

Be sure to turn on the FP5 power before connecting the program adapter or target system.

- <1> Connect the FP5 GND connector to the program adapter using a GND cable.

Caution The FP5 and target system may be damaged if the voltage between the FP5 GND and the target system GND is different. Use the GND cable to match the voltage before connecting the target cable.

- <2> Connect the FP5 target connector to the program adapter using the target cable.

Remark Connect the target system before supplying V_{DD}/V_{DD2} power from the target system.

(5) Startup of programming GUI

- <1> Click the Start menu, “All Programs”, point to “Renesas Electronics CubeSuite+”, “Programming Tools”, and then select “PG-FP5 Vx.xx” of “PG-FP5 Vx.xx” to start the Programming GUI. The valid communication modes are automatically detected in the order of the USB, and then the serial interface.

Figure 5-1. Connection Between Programming GUI and FP5

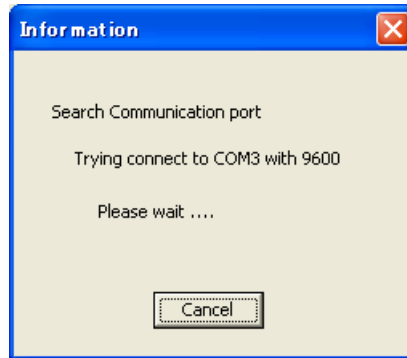

- <2> The communication mode can also be selected by cancelling this operation with the **Cancel** button and selecting the **[Setup host connection]** command in the **[Programmer]** menu.

<R>

Figure 5-2. [Setup host connection] Command

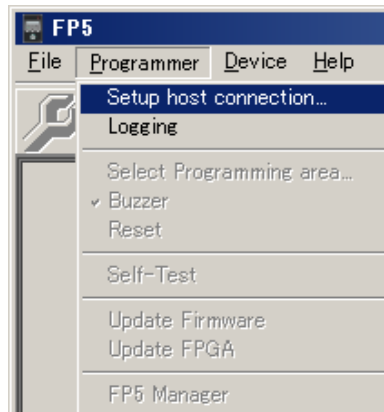

<3> Perform settings according to the communication port connected to the FP5.

Figure 5-3. Communication Parameter Setup

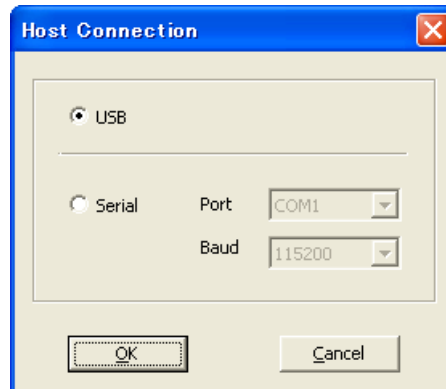

<4> Click the **OK** button to enable the new port settings.

<5> When the programming GUI is correctly started, the main window will be opened. The following message will be displayed if the programming GUI is started for the first time or valid programming areas have been cleared, so click the **OK** button. The Device Setup dialog box will be opened.

Figure 5-4. Message Displayed at the First Startup of Programming GUI

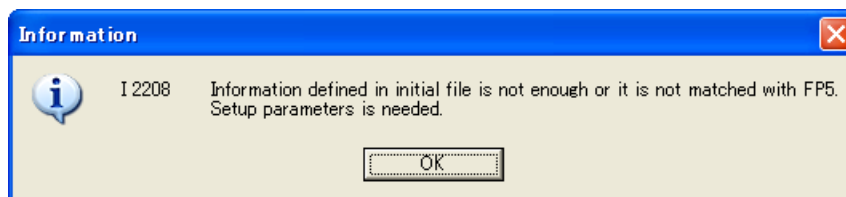

The following dialog box will be displayed. Click **Yes** or **No**.

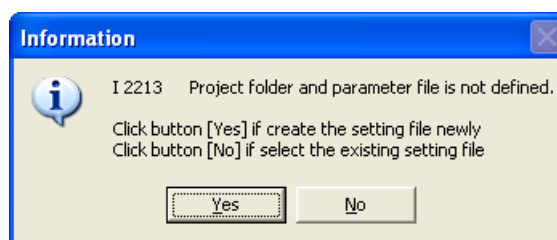

Clicking **Yes** will open a dialog box to make a new ESF file. Refer to 4.3.3 (15) (a) <3> **New...** Button for the steps that follow.

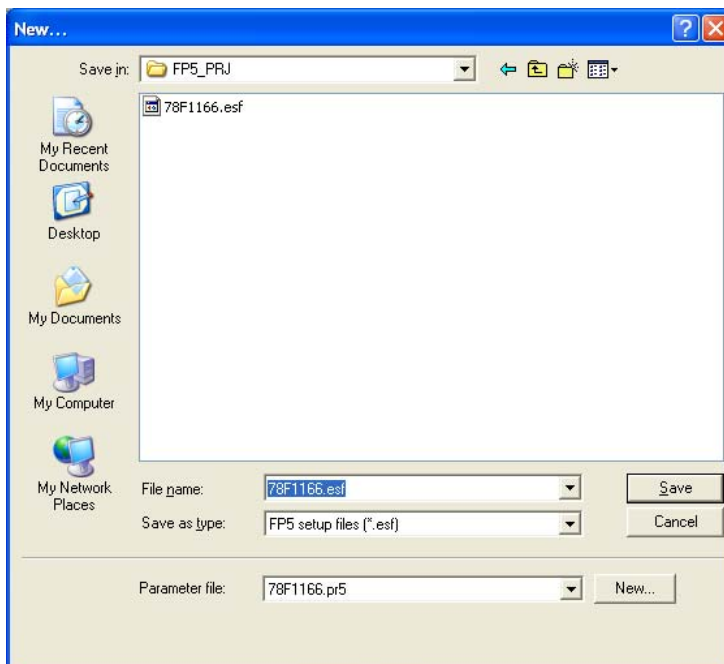

Clicking 'No' will open a dialog box to select a previously created ESF file. Refer to 4.3.3 (15) (a) <3> **...** Button for the steps that follow.

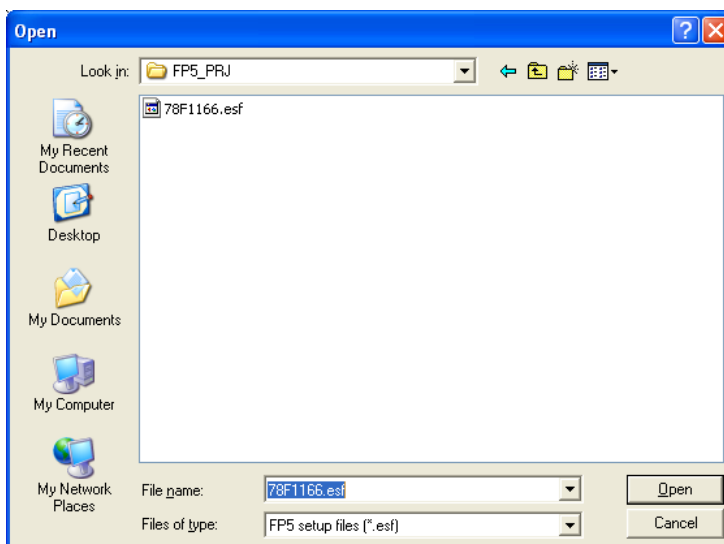

Next, the device setup dialog box that is opened when [Device] menu -> [Setup...] command is executed will be opened, so make the settings.

<R>

Figure 5-5. Main Window

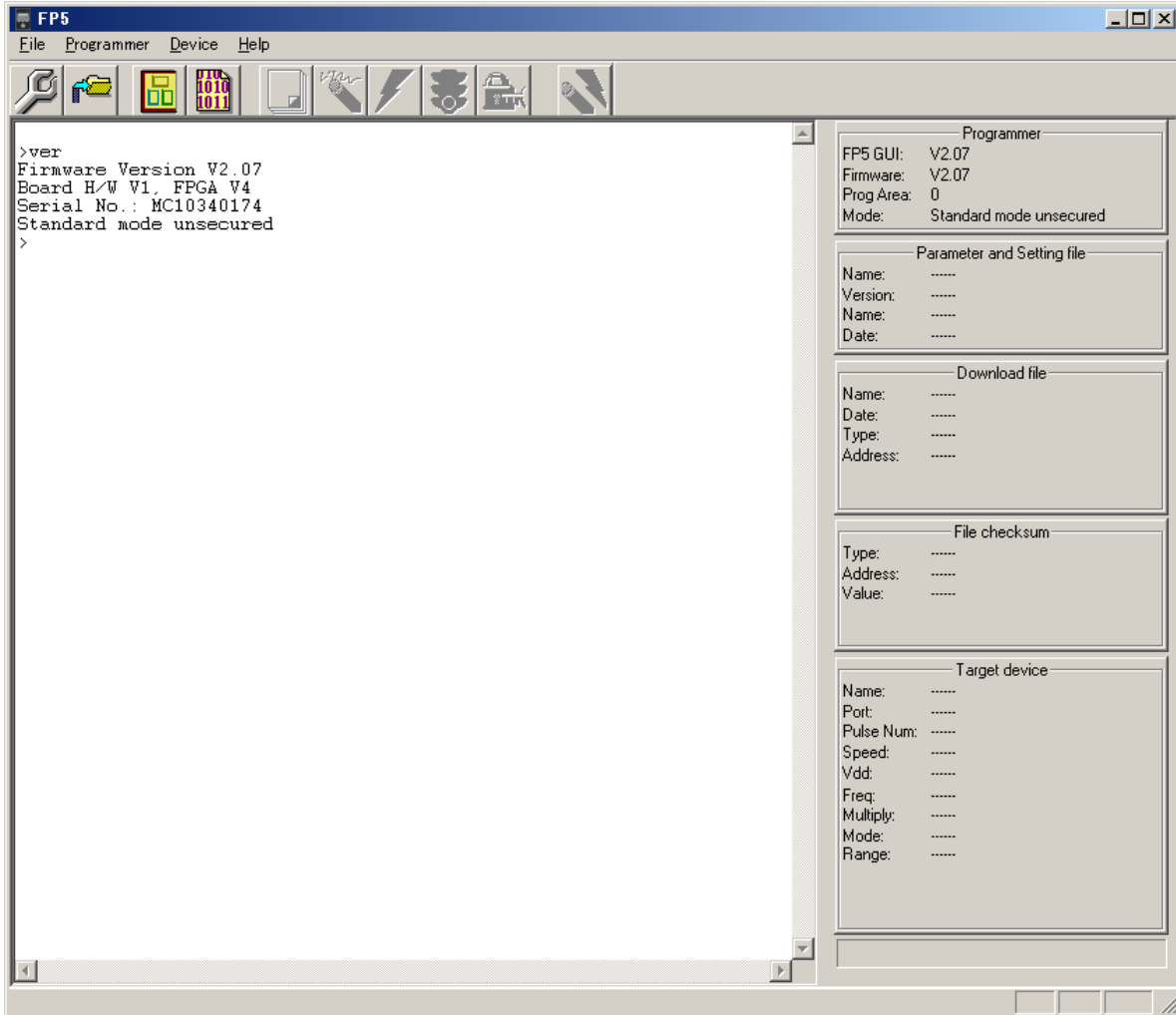

(6) Setting of programming environment

<1> Execute the [Setup...] command in the [Device] menu in the main window.

<R>

Figure 5-6. [Setup] Command

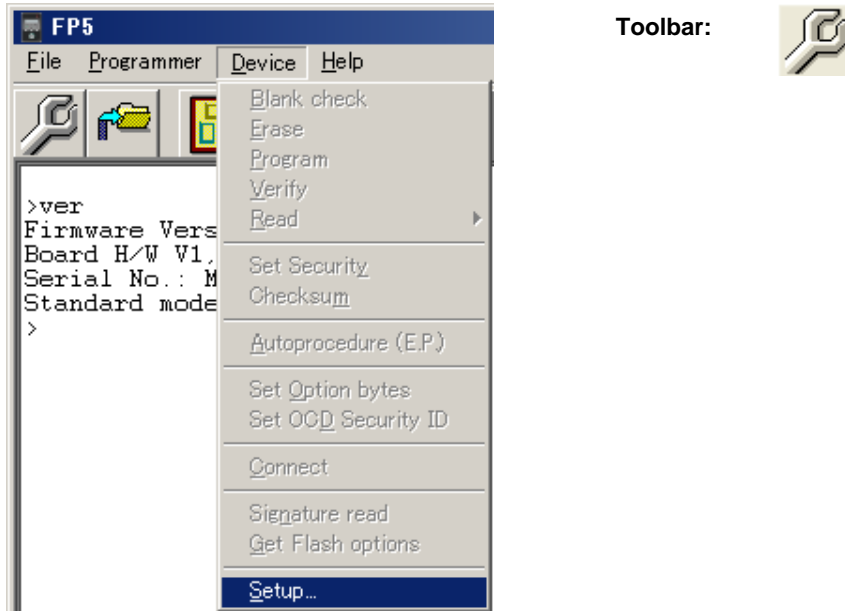

<2> The Device Setup dialog box ([Target] tab) is opened.

<R>

Figure 5-7. Device Setup Dialog Box - [Target] Tab

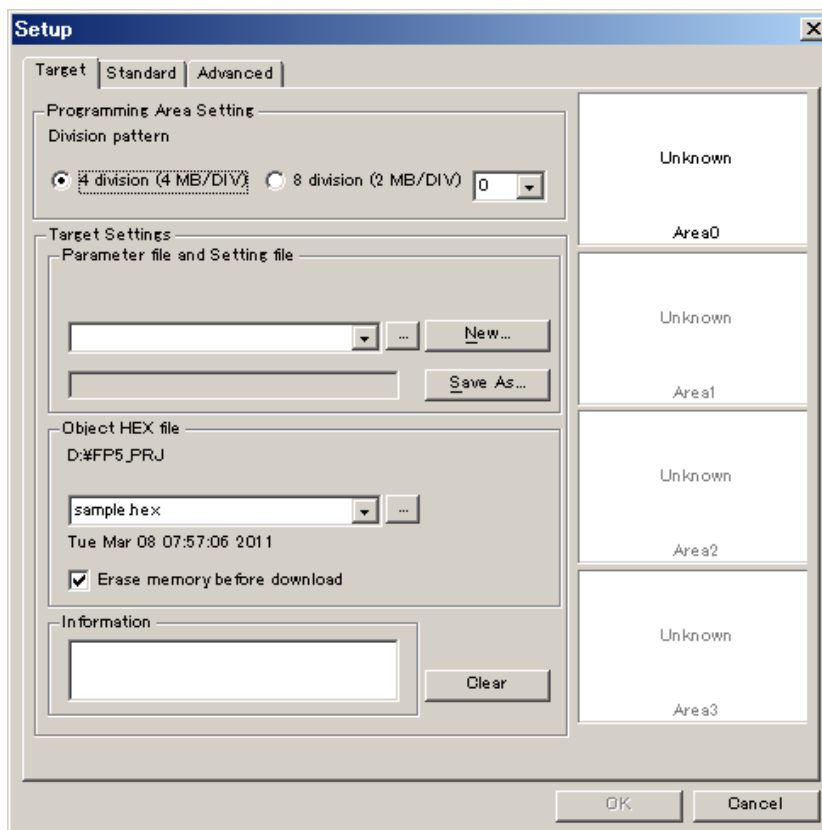

<3> Set the [Programming Area Setting] area. In this example, 4-divided Area 0 is selected.

Figure 5-8. Setting of [Programming Area Setting] Area

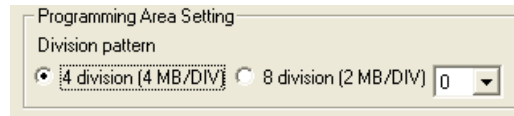

<4> Click the **New...** button to create a new ESF file for the μ PD78F1166.

Figure 5-9. Creation of New ESF File

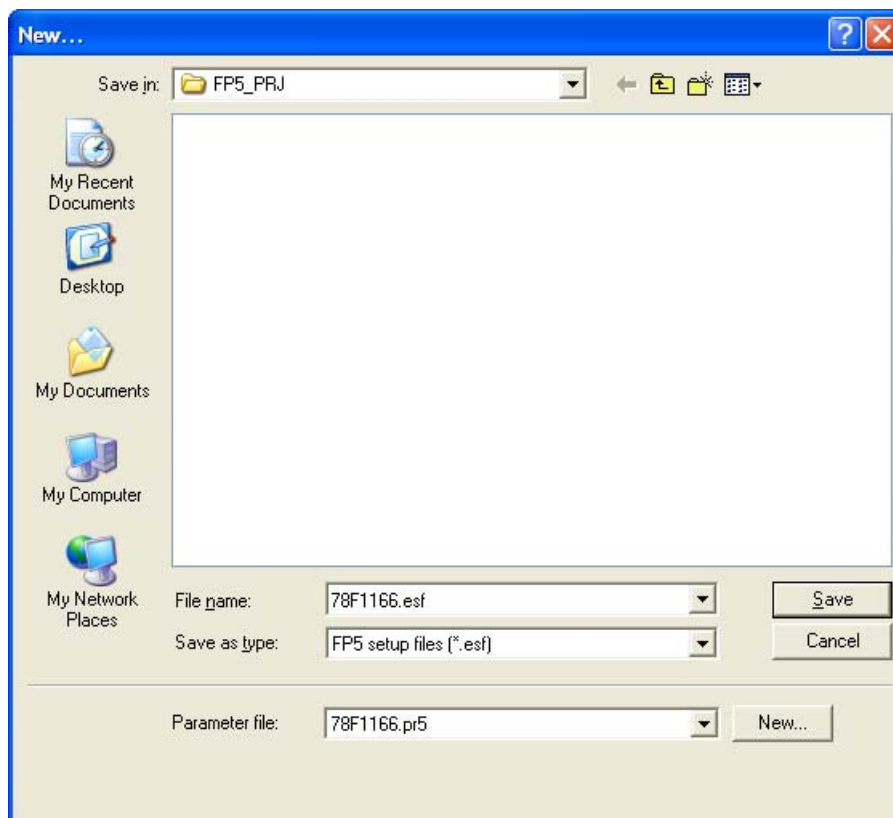

<5> Select 78F1166.pr5 from the [Parameter file] list. If this file is unlisted, use **New...** button.

Figure 5-10. Selecting PR5 File

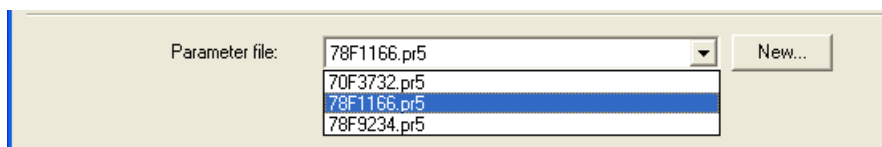

<6> Type the name of the newly created ESF file and click the **Save** button.

Figure 5-11. Saving ESF File



<7> Select the program file. Click the **...** button in the [Object HEX file] area.

<R>

Figure 5-12. [Object HEX file] Area

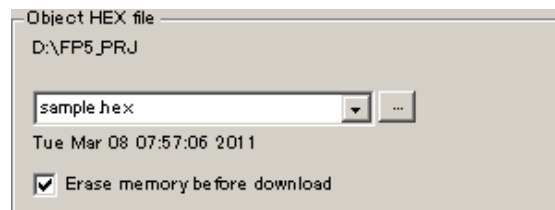

<8> Select the program file and click the **Open** button. In this example, "sample.hex" is selected.

<R>

Figure 5-13. Selection of Program File

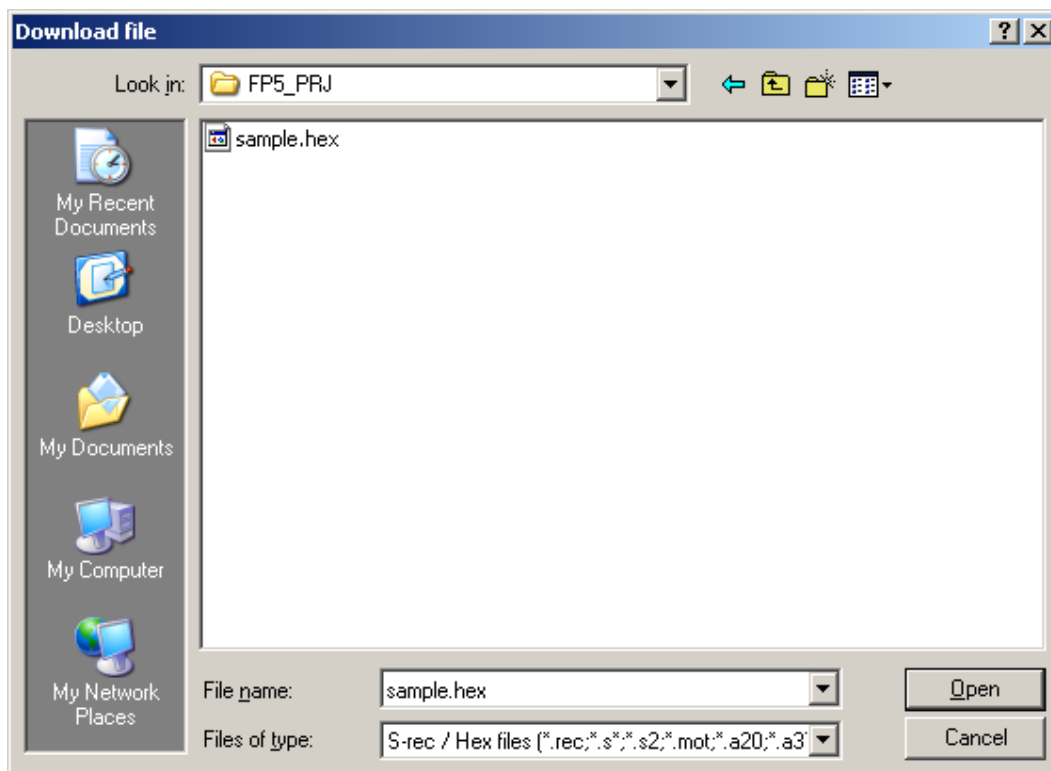

<9> Click the [Standard] tab.

Figure 5-14. Device Setup Dialog Box - [Standard] Tab

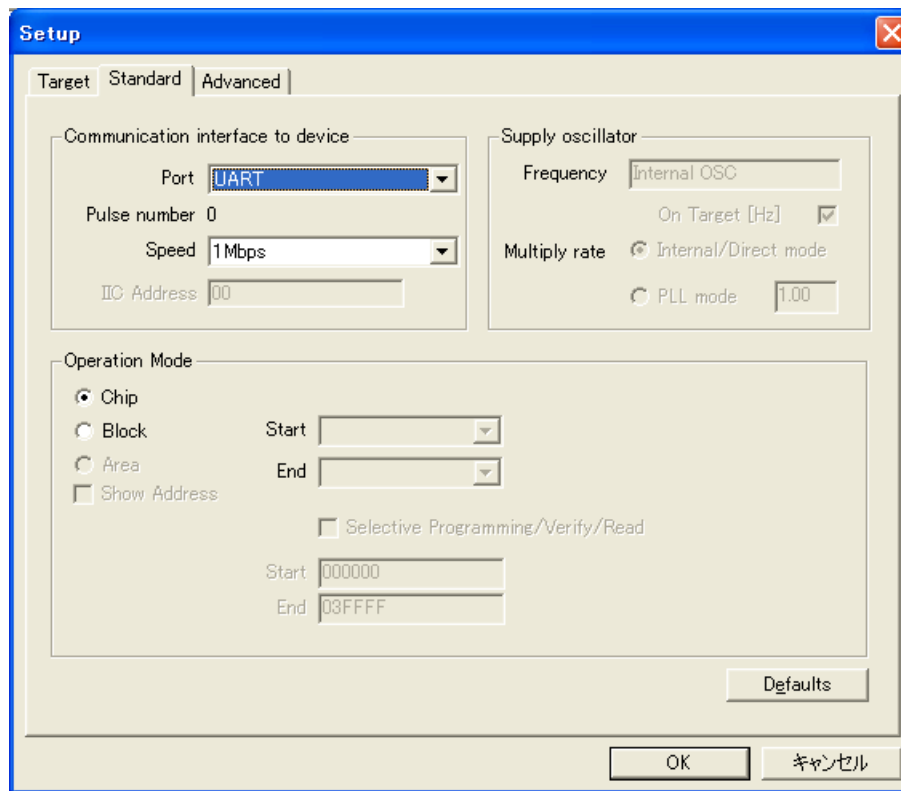

<10> Set the items in accordance with the programming environment used. In particular, set the [Communication interface to device] area and [Supply oscillator] area in accordance with the specifications of the device selected. Specify a flash memory range to be manipulated in the [Operation Mode] area (the flash memory range that can be set is defined by the PR5 file according to the specifications of the device). In this example, it is assumed that the following settings are made.

[Communication Interface to device] area

Port: UART
Speed: 1M Baud

[Supply oscillator] area

On Target: Unavailable (using internal oscillator)
Frequency: Unavailable (Internal OSC)
Multiply rate: Unavailable (Internal/Direct mode)

[Operation Mode] area

Chip

<11> Click the [Advanced] tab.

<R>

Figure 5-15. Device Setup Dialog Box - [Advanced] Tab

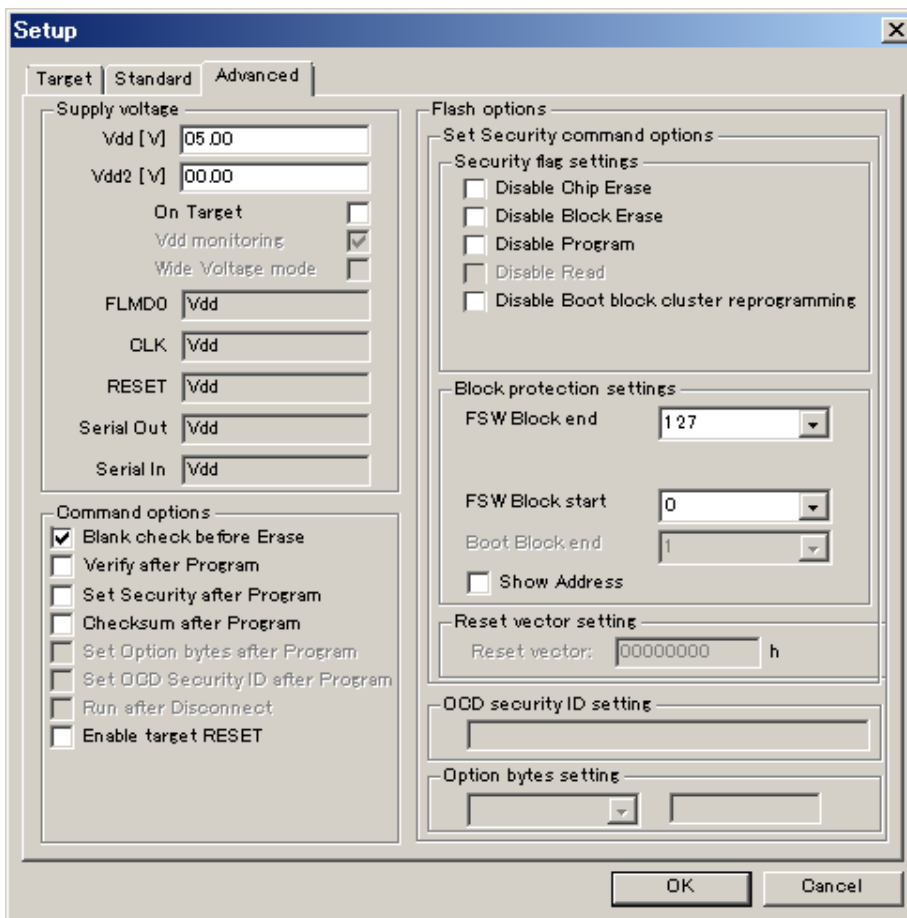

<12> Check the information in the [Supply voltage] area to make sure that they are set in accordance with the programming environment used.

In this example, it is assumed that the following settings are made.

[Supply voltage] area

Vdd[V]: 5.00 V (Follows the value set in the PR5 file.)

Vdd2[V]: 0.00 V (Not used; follows the value set in the PR5 file.)

[On Target] check box

Cleared (Power is supplied from FP5.)

[Command options] area

Blank check before Erase: Selected

[Flash options] area

Not used

Remark Set Vdd [V] and Vdd2 [V] and select the [On target] check box before supplying V_{DD}/V_{DD2} power from the target system.

<13> Click the **OK** button in the Device Setup dialog box.

<14> The programming GUI loads the PR5 file, ESF file and program file to the FP5. When setting is completed, the following window will be displayed. Setting of the programming environment is then finished.

<R>

Figure 5-16. Downloading of PR5 File, ESF File and Program File

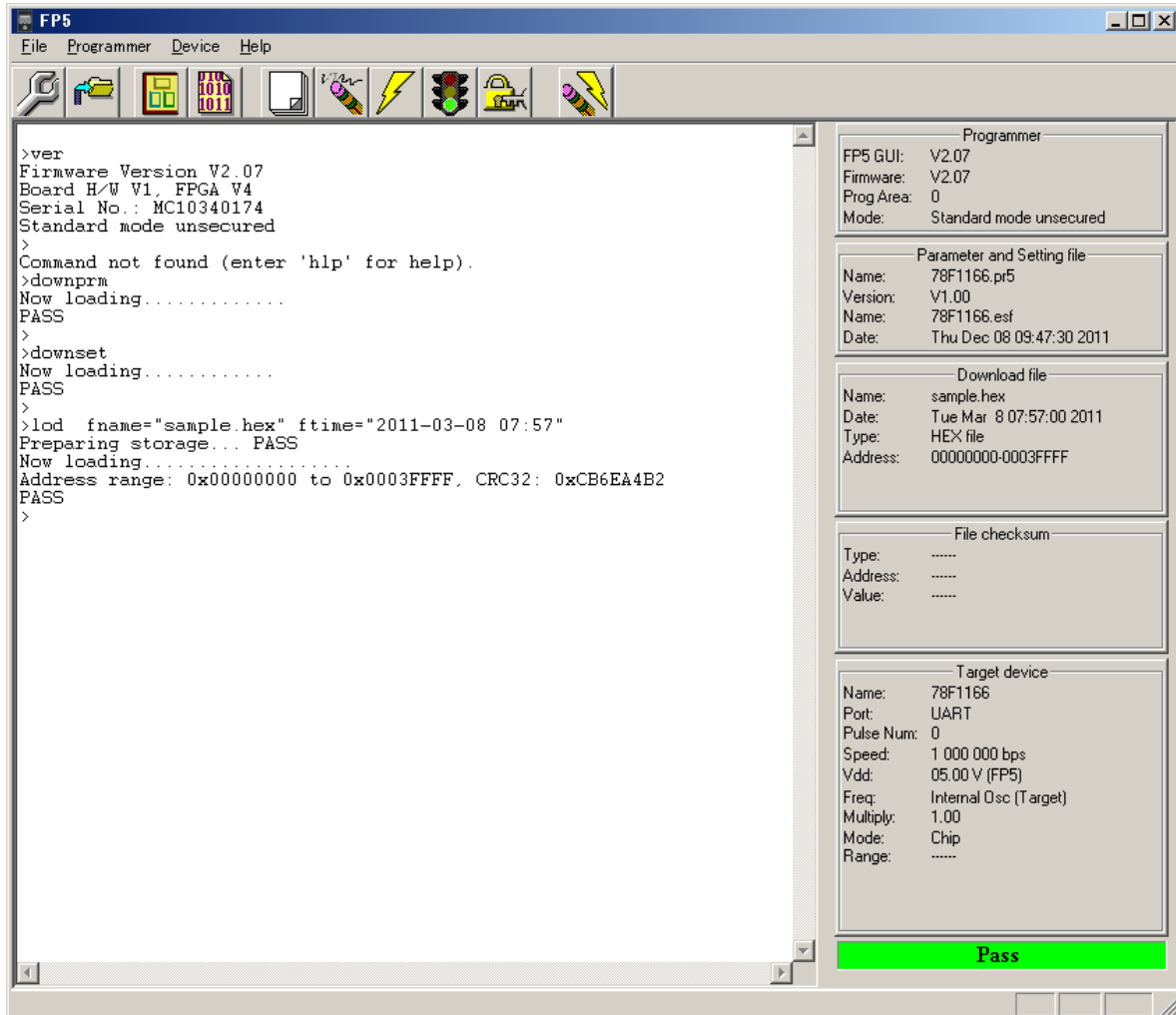

(7) Execution of [Autoprocedure(E.P.)] command

Execute the [Autoprocedure(E.P.)] command in the [Device] menu.

<R>

Figure 5-17. [Autoprocedure(E.P.)] Command

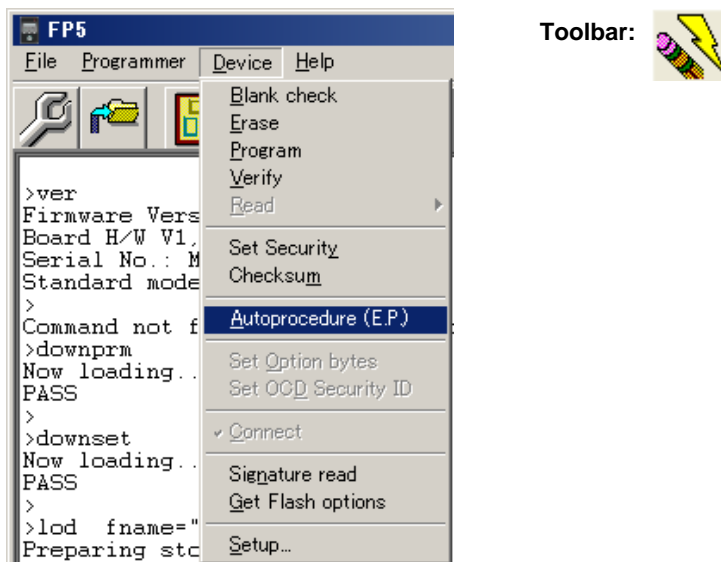

When the [Autoprocedure(E.P.)] command is executed, the [Blank check], [Erase] (if the target area is not blank) and [Program] commands are executed in that order for the UPD78F1166.

- Remarks 1.** If necessary, insert the target device to be newly written to in the program adapter, and execute the [Autoprocedure(E.P.)] command.
- 2.** Turn off power, connect the target system to be newly written to, and execute the [Autoprocedure(E.P.)] command after power is supplied, before supplying V_{DD}/V_{DD2} power from the target system.

If execution of the [Autoprocedure(E.P.)] command is normally completed, "Erase, Program operation finished" is displayed in the action log window.

<R>

Figure 5-18. [Autoprocedure(E.P.)] Command Execution Result

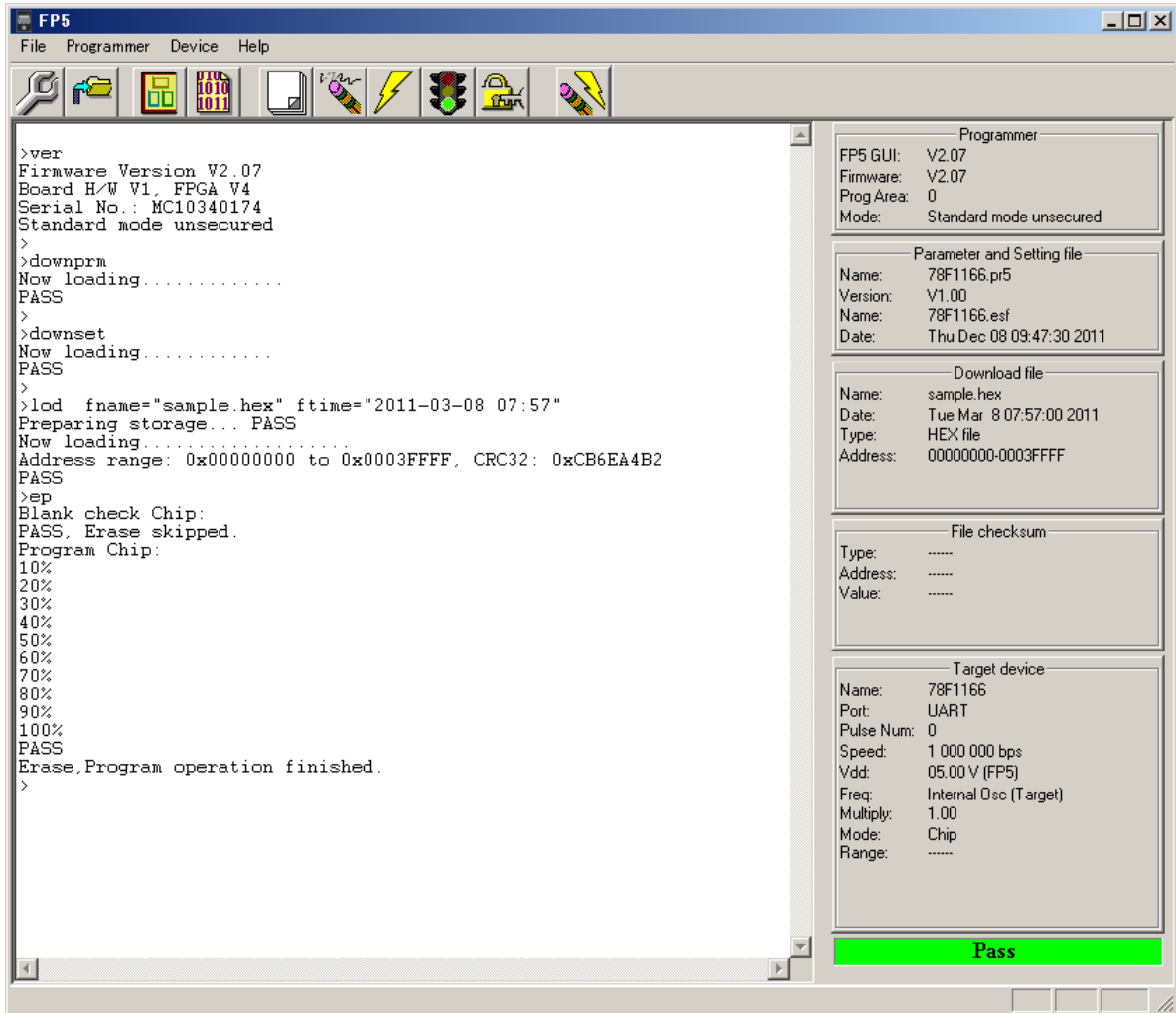

(8) System shutdown

<1> Remove the program adapter from the target cable.

Remark Turn off power and remove the target system before supplying V_{DD}/V_{DD2} from the target system.

<2> If no more target devices are to be written to, execute the [Quit] command in the [File] menu to terminate the programming GUI. All the settings made so far are saved, so they can be restored when the programming GUI is restarted. (The PR5 files, ESF files and program files are saved to the FP5 internal flash memory.)

<3> Press and hold the **POWER** button on the FP5 for about 1 second to turn off the POWER LED.

<4> Remove the AC adapter and USB cable from the FP5.

Caution If an error occurred during the above steps, refer to **CHAPTER 12 TROUBLESHOOTING** and **APPENDIX A MESSAGE**. In addition, refer to 4.3.2 (6) [Self-Test] command and perform selftesting.

If this does not resolve the problem, see the FAQ (except for Europe area:

<R> <http://www.renesas.com/supp/>, for Europe area: <http://www.renesas.eu/update>) or access
<R> <http://www.renesas.com/contact/> for inquiry.

CHAPTER 6 USAGE IN STANDALONE MODE

The FP5 has a standalone mode in which the FP5 by itself can execute the [Erase], [Program], and [Autoprocedure(E.P.)] commands without a host machine. This mode is useful for using the FP5 on the production line during mass production and for upgrading in the field.

6.1 Before Starting Standalone Operation

In standalone mode, the FP5 can select any programming area based on PR5 files, ESF files and program files stored in the multiple internal flash memory areas (programming areas) and write it. New PR5 files, ESF files and program files cannot be downloaded to the FP5 in this mode. Programming is possible only in environments to which files were downloaded last time by the programming GUI.

6.2 Description of Buttons, Message Display and Status LEDs

In standalone mode, command menus are selected and executed using the control button [NEXT], [ENTER], [CANCEL] or [START] on the top of the FP5 main unit.

The selected command menu is displayed in the message display, and the result of command execution is indicated by the message display and status LEDs. When the FP5 Manager dialog box is used to enable [Enable Bank mode] or [Enable Simple mode], the functions of the control buttons and message display will change. Refer to **4.3.2 (9) [FP5 Manager] command** and **CHAPTER 7 USAGE THE REMOTE CONNECTOR FOR DETAILS**. This chapter will describe usage in the normal mode.

The command menu consists of two levels of menus: a main menu and submenu.

The [NEXT] button is used to display the next menu on the same level.

The [ENTER] button is used to select or execute the menu item currently displayed.

The [CANCEL] button is used to cancel the current selection and return to the previous menu level. The command currently running cannot be stopped, except for the [Read] command.

The [START] button executes the [Autoprocedure(E.P.)] command. It can be executed from any command menu, and the display returns to the same command menu after execution.

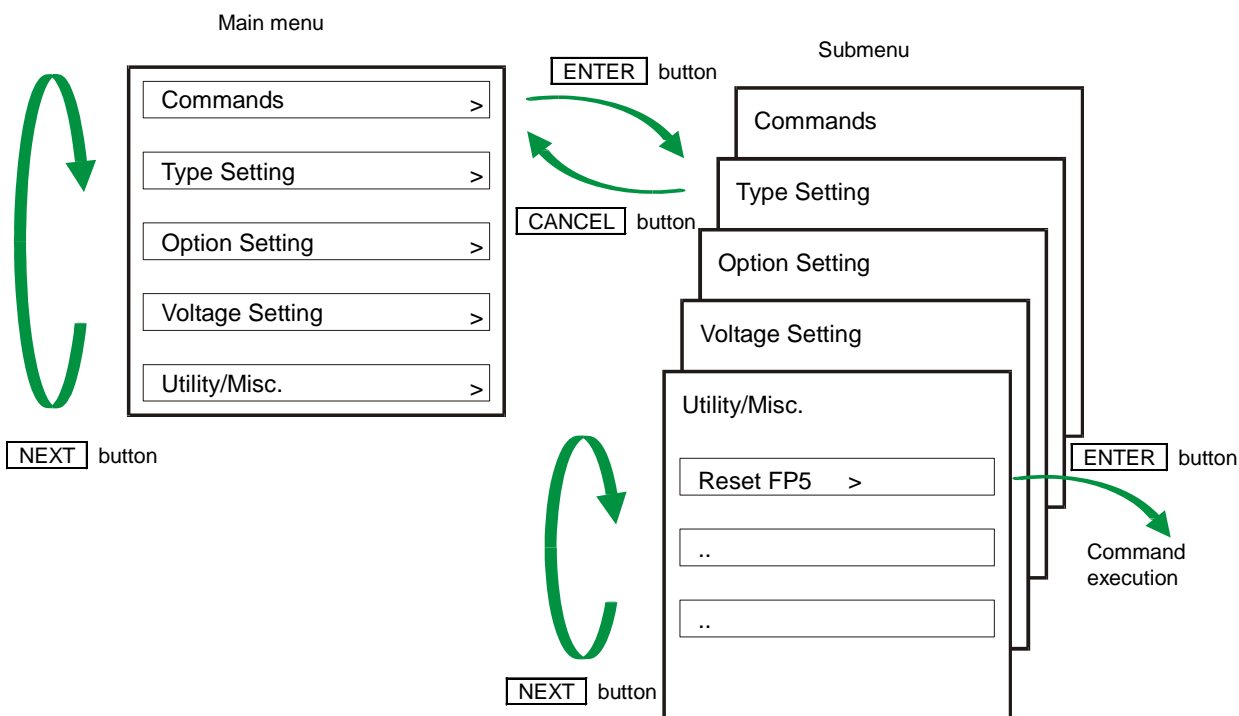

Figure 6-1. Menu Status Transition by Button Input



On the main menu level, the FP5 shows the menu items that can be selected. On the submenu level, the first line in the message display shows the menu item and the second line shows the response from the FP5, if any.

A command prompt '>' displayed at the end of a menu line indicates that it is selectable with the **ENTER** button, or that the menu (command) can be executed. If the command prompt '>' is not displayed at the end of a menu line, it means that the function is available only for display.

When power to the FP5 is turned on, the POWER LED turns on and 'Commands >' is displayed in the message display. The status LEDs indicate the status of communication with the device and the result of execution, as follows.

Status LED	Status
 Green	The selected command has been executed correctly. The command that has been correctly executed is displayed in the message display.
 Orange	The selected command is under execution. The detailed execution status is displayed in the message display.
 Red	The selected command has been terminated by an error. The error details are displayed in the message display.

Remark For details on the errors displayed in the message display, refer to error message **A.4 Error Messages Displayed in FP5 Message Display**.

6.3 Standalone Operation Menu

In standalone mode, the programming environment of the target device can be checked and then programs can be written by using the commands explained in this section.

6.3.1 [Commands] menu

The [Commands] menu provides various commands required for programming the target device. Select a command from this menu and press the **[ENTER]** button; the FP5 will then execute the command for the target device, based on the settings downloaded to the valid programming area. For details on command execution, refer to 4.3.3 [Device] menu.

Table 6-1. [Commands] Menu (1/2)

Main Menu	Submenu	Description
[Commands >]	[E.P. >]	Pressing the [ENTER] button executes the [Autoprocedure(E.P.)] command.
	[Program >]	Pressing the [ENTER] button executes the [Program] command.
	[Erase >]	Pressing the [ENTER] button executes the [Erase] command.
	[Verify >]	Pressing the [ENTER] button executes the [Verify] command.
	[Set Security >]	Pressing the [ENTER] button executes the [Set Security] command.
	[Checksum >]	Pressing the [ENTER] button executes the [Checksum] command. The checksum value read from the target device is displayed in the message display. <When a product with no data flash is selected from the 78K/V850/RL78 family> Checksum:xxxx <When a product with data flash is selected from the 78K/V850/RL78 family> Code Flash sum: xxxx -> Enter Click the [ENTER] button. Data Flash sum: xxxx -> Enter Click the [ENTER] button. Total sum: xxxx -> Enter <When RX family, R8C family, or SuperH family is selected> User mat sum: xxxxxxxx -> Enter Click the [ENTER] button. Data mat sum: xxxxxxxx -> Enter Click the [ENTER] button. UB mat sum: xxxxxxxx -> Enter Click the [ENTER] button. Total sum: xxxxxxxx -> Enter The comparison result is also displayed if [Enable checksum compare function] in FP5 management setting is enabled. Checksum: Compare:PASS (or ERROR)

<R>

Table 6-1. [Commands] Menu (2/2)

Main Menu	Submenu	Description
<R> [Commands >]	[Set OptionBytes >]	Pressing the ENTER button executes the [Set Option bytes] command.
	[Set OCD-Sec-ID >]	Pressing the ENTER button executes the [Set OCD Security ID] command.
	[Set Lock bits >]	Pressing the ENTER button executes the [Set Lock bits] command.
	[Blank check >]	Pressing the ENTER button executes the [Blank check] command.
	[Signature >]	Pressing the ENTER button executes the [Signature read] command. The device name is displayed in the message display. Display example: Signature: D78F1166
	[Connect >]	Pressing the ENTER button executes the con command.
	[Disconnect >]	Pressing the ENTER button executes the dcon command.
	[Prog Area >]	Used to select the valid programming area from the four (4 MB each) or eight (2 MB each) programming areas in the FP5. The valid programming area can be changed by pressing the ENTER button. <Display example> (if ENTER button is pressed): Commands Prog Area now: 1 (Changes the valid programming area from Area 0 to Area 1.) The currently selected programming area can be checked in the [Programmer] area in the programming parameter window of the programming GUI. The factor for dividing the programming area is the value set in the [Programming Area Setting] area in the Device Setup dialog box.

6.3.2 [Type Setting] menu

The [Type Setting] menu is used to check information (target device programming environment settings) contained in the ESF file downloaded to the FP5. The settings downloaded to the valid programming area are displayed. All the values displayed are those downloaded last time by the programming GUI. The settings cannot be changed using this menu.

Table 6-2. [Type Setting] Menu

Main Menu	Submenu	Description
[Type Setting >]	[Device Port]	Displays any of the following to indicate which mode is selected for communication between the target device and the FP5. SIO 0, SIO 1, SIO 2, SIO H/S, IIC 0, IIC 1, IIC 2, IIC 3, UART 0, UART 1, UART 2, UART 3, PORT 0, PORT 1, PORT 2
	[Multiply Rate]	Displays the multiplication rate of the operating clock for the target device.
	[Serial CLK]	Displays the serial clock rate in Hz that is used for communication between the target device and the FP5.
	[CLK source]	Indicates either of the following as a source of the operating clock supplied to the target device. Programmer: Clock is supplied from the FP5. Target: Clock is supplied from the user system.
	[PG CPU CLK]	Indicates the frequency of the clock supplied from the FP5 in MHz.
	[Target CPU CLK]	Indicates the frequency of the clock on the user system that is supplied to the target device, in MHz.
	[Operation Mode]	Indicates <i>chip</i> , <i>area</i> , or <i>block</i> as the operation mode when the [Blank check], [Erase], [Program], [Verify], [Checksum], or [Autoprocedure(E.P.)] command is executed. Chip, Area, Block, Block(Code), Block(Data), Block(Code+Data) <Display example> Operation Mode Chip
	[Operation Range]	Indicates which of the areas in the target device connected to the FP5 is to be written to. This menu shows a valid display only when the operation mode is not Chip (when the operation mode is Area or Block). <Display example> Operation Range 0 to 1 *In chip mode, the display is always as follows: <Display example> Operation Range 0 to 127

<R>

6.3.3 [Option Setting] menu

The [Option Setting] menu is used to check the command options and security settings currently set for the FP5. The settings downloaded to the valid programming area are displayed. All the values displayed are those downloaded last time by the programming GUI. The settings cannot be changed using this menu.

Table 6-3. [Option Setting] Menu (1/2)

Main Menu	Submenu	Description
[Option Setting >]	[BLN before ERS]	Displays the setting of the [Blank check before Erase] check box in the [Command options] area on the [Advanced] tab in the Device Setup dialog box. on: Selected, off: Not selected
	[VRF after PRG]	Displays the setting of the [Verify after Program] check box in the [Command options] area on the [Advanced] tab in the Device Setup dialog box. on: Selected, off: Not selected
	[SCF after PRG]	Displays the setting of the [Security after Program] check box in the [Command options] area on the [Advanced] tab in the Device Setup dialog box. on: Selected, off: Not selected
	[SUM after PRG]	Displays the setting of the [Checksum after Program] check box in the [Command options] area on the [Advanced] tab in the Device Setup dialog box. on: Selected, off: Not selected
	[OPB after PRG]	Displays the setting of the [Set Option bytes after Program] check box in the [Command options] area on the [Advanced] tab in the Device Setup dialog box. on: Selected, off: Not selected
	[IDC after PRG]	Displays the setting of the [Set OCD Security ID after Program] check box in the [Command options] area on the [Advanced] tab in the Device Setup dialog box. on: Selected, off: Not selected
	[Run after Disc.]	Displays the setting status of the [Run after Disconnect] check box in the [Command options] area of the device setup dialog [Advanced] tab. On: Checked Off: Not checked When on, the FP5 Manager [Reset option of Run after Disconnect] setting will also be displayed. <Display example> On (Hi-Z)
	[Enable targetRes]	Displays the setting status of the [Enable target Reset] check box in the [Command options] area of the device setup dialog [Advanced] tab. On: Checked Off: Not checked
	[Prog Area]	Displays the valid programming area from the four (4 MB each) or eight (2 MB each) programming areas in the FP5. Display example (in the case when the valid programming area is Area 0): Prog Area On (0)
	[Chip ERS dis.]	Displays the setting of the [Disable Chip Erase] check box in the [Security flag settings] area on the [Advanced] tab in the Device Setup dialog box. on: Selected, off: Not selected
[Block ERS dis.]	Displays the setting of the [Disable Block Erase] check box in the [Security flag settings] area on the [Advanced] tab in the Device Setup dialog box. on: Selected, off: Not selected	

<R>

Table 6-3. [Option Setting] Menu (2/2)

Main Menu	Submenu	Description
[Option Setting >]	[PRG disable]	Displays the setting of the [Disable Program] check box in the [Security flag settings] area on the [Advanced] tab in the Device Setup dialog box. on: Selected, off: Not selected
	[READ disable]	Displays the setting of the [Disable Read] check box in the [Security flag settings] area on the [Advanced] tab in the Device Setup dialog box. on: Selected, off: Not selected
	[Boot Blk PRG dis]	Displays the setting of the [Disable boot block cluster reprogramming] check box in the [Security flag settings] area on the [Advanced] tab in the Device Setup dialog box. on: Selected, off: Not selected
	[Reset Vector]	Displays the setting of the [Reset vector:] check box in the [Reset vector settings] area on the [Advanced] tab in the Device Setup dialog box. Display example: Reset vector Addr: 0x000000
	[End Boot Blk]	Displays the setting of the [Boot Block end] check box in the [Block protection] area on the [Advanced] tab in the Device Setup dialog box. Display example: End Boot Blk 0
	[FS area]	Displays the setting of the [FSW Block start] and [FSW Block end] check boxes in the [Block protection] area on the [Advanced] tab in the Device Setup dialog box. Display example: FS area 0 to 127
	[OCD ID: xxxxxxxx]	Displays the setting of the [OCD security ID setting] box in the [OCD security ID setting] area on the [Advanced] tab in the Device Setup dialog box. Display example: If 123456789ABCDEF123456789 is specified in the [OCD security ID setting] box OCD ID: 12345678 9ABCDEF123456789
	[OPBTx x = 0 to 8]	Displays the setting of the [Option bytes setting] box in the [Option bytes setting] area on the [Advanced] tab in the Device Setup dialog box. If the [NEXT] button is clicked, the display changes from OPBT0 to OPBTx. Display example: If FFFFFFFE9 is specified for OPBT0 in the [Option bytes setting] area OPBT0 FFFFFFE9

6.3.4 [Voltage Setting] menu

The [Voltage Setting] menu is used to check the voltage level setting used when programming the target device currently connected to the FP5. The settings downloaded to the valid programming area are displayed. The settings cannot be changed using this menu.

Table 6-4. [Voltage Setting] Menu

Main Menu	Submenu	Description
[Voltage Setting >]	[Vdd]	Displays the value of V_{DD} supplied to the target device connected to the FP5 in volts.
	[Vdd2]	Displays the value of V_{DD2} supplied to the target device connected to the FP5 in volts.
	[Vdd Source]	Indicates the source of V_{DD} supplied from the target device as either of the following. V_{DD} from PG: V_{DD} is supplied from the FP5. V_{DD} from device: V_{DD} is supplied from the user system.
	[Vdd Monitoring]	Displays the setting of the [Vdd monitoring] check box in the [Supply voltage] area on the [Advanced] tab in the Device Setup dialog box. on: Selected, off: Not selected
	[FLMD0 Level]	The FLMD0 Level displays the voltage level of the FLMD0 signal.
	[CLK Level]	Indicates the voltage level of the clock signal as either of the following. VDD VDD2
	[RESET Level]	The Reset Level displays the voltage level of the $\overline{RES\bar{E}T}$ signal. VDD Also, when the [Enable target RESET] check box in the [Command options] area of the device setup dialog [Advanced] is enabled, "VDD Reset Trigl" is displayed.
	[Serial Level]	Indicates the voltage level of the serial communication signals. The high level of the serial communication signal is indicated as either of the following. VDD VDD2
	[Vpp]	Indicates the value of V_{PP} supplied to the target device connected to the FP5 in volts.

6.3.5 [Utility/Misc.] menu

The [Utility/Misc.] menu is used to reset the FP5 main unit, tune the LCD contrast, check the firmware version, check the name and version of the PR5 file downloaded, check the name of the program file downloaded, and check the checksum of program files. The settings downloaded to the valid programming area are displayed. The settings cannot be changed using this menu.

Table 6-5. [Utility/Misc.] Menu

Main Menu	Submenu	Description
[Utility/Misc. >]	[Utility]	Displays the FP5 Manager mode settings. <Display example> Std. mode Sec Std. mode unSec
	[Reset FP5 >]	Pressing the [ENTER] button resets the FP5.
	[Set LCD Contr. >]	Tunes the contrast in the message display. After pressing the [ENTER] button, the contrast can be tuned using the [NEXT] (darken) or [CANCEL] button (lighten). To fix the contrast, click the [ENTER] button.
	[FP5 F/W Version]	Displays the FP5 firmware version. <Display example> FP5 F/W Version V1.00
	[PRM Name]	Displays the name of the PR5 file stored in the FP5 valid programming area. <Display example> PRM Name 78F1166
	[PRM File Version]	Displays the version of the PR5 file stored in the FP5 valid programming area. <Display example>: PRM File Version V1.00
	[HEX File Name]	Displays the name of the program file stored in the FP5 valid programming area. <Display example> HEX File Name Sample.hex "n.a." is displayed if the program file is invalid.
	[File Checsum]	File Checsum will display the results of executing the programming GUI [File] menu -> [Checksum...] command. <Display example> File Checsum 623E (ARITHM.)

CHAPTER 7 USAGE THE REMOTE CONNECTOR

This chapter describes the use of the remote connector.

The FP5 can be remote controlled by connecting the remote connector and external control device. Remote control can be used to operate and check writing and PASS/ERROR displays from the external control device.

7.1 Remote Interface Mode

The remote interface has a standard mode and a bank mode.

The modes are switched by using the FP5 Manager [Enable Bank mode] check box.

Standard mode: The same signals as the control buttons (NEXT, ENTER, CANCEL) on the command menu of the FP5 unit can be input.

Bank mode: This mode allows inputting of the bank signals (BANK0-2) that indicate the programming area. The control buttons (NEXT, ENTER, CANCEL) will change their functions to those inputting bank signals, so that the command menu displayed on the FP5 message display will be disabled.

7.2 Remote Connector Pins

The FP5 remote connector pins have the following functions. All inputs will become active with an effective level of 50 ms or greater. Note that the pin numbers in Table 7-1 are the pin numbers on the FP5 remote connector.

Table 7-1. Remote Interface Pin Functions (1/2)

Pin number	Input/ Output	Pin name		Function	Active level
1	Output	CONN		Indicates that the remote interface is connected. When the FP5 power is ON, the CONN is always valid.	High level
2	Output	BUSY		Outputs the status indicated by the status LED "BUSY". Note that the BUSY signal differs from the status LED and does not blink.	High level
3	Output	PASS		Outputs the status indicated by the status LED "PASS".	High level
4	Output	ERROR		Outputs the status indicated by the status LED "ERROR".	High level
5	Input	Standard mode	CANCEL	Same as the CANCEL button function.	Low level
	Input	Bank mode	BANK0	Indicates the lowest 1 bit of the 3-bit programming area number.	Low level
6	Input	Standard mode	ENTER	Same function as the ENTER button.	Low level
	Input	Bank mode	BANK1	Indicates the middle 1 bit of the 3-bit programming area number.	Low level
7	Input	Standard mode	NEXT	Same as the function of the NEXT button.	Low level
	Input	Bank mode	BANK2	Indicates the highest 1 bit of the 3-bit programming area number.	Low level

Table 7-1. Remote Interface Pin Functions (2/2)

Pin number	Input/Output	Pin name	Function	Active level
8	Input	VRF	Inputs the independent verify signal.	Low level
9	Input	START	Inputs the "START" (Auto-procedure (E.P.)) signal.	Low level
10	Input	CLR	Clears (disables) the "PASS" and "ERROR" signals.	Low level
11 to 15	–	GND	Grounding pin	–

Table 7-2. Programming Area and Banks

	BANK2	BANK1	BANK0
Programming area 0	0	0	0
Programming area 1	0	0	1
Programming area 2	0	1	0
Programming area 3	0	1	1
Programming area 4	1	0	0
Programming area 5	1	0	1
Programming area 6	1	1	0
Programming area 7	1	1	1

- Remarks 1.** 0: Low level
 1: High level
- 2.** When set in programming area 0, set in programming area 0, set BANK0, BANK1, and BANK2 to the low level.
 When set in programming area 3, set BANK0 and BANK1 to the high level, and BANK2 to the low level.

Next, the pin assignment of the remote connector is shown.

Figure 7-1. Remote Connector (D-SUB 15 pin connector (female)) Pin Assignment

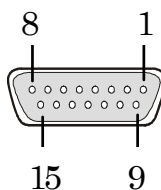

Remark Remote connector (D-SUB 15 pin connector (female)) model number: 07433FB015S200ZU (Suyin Connector)

7.3 Equivalence Circuits

In the DC properties of the remote interface, 4.7 k-ohm pull-up processing is executed so that the output signal has CMOS output from 74LV126A (3.3 V) and the input signal has input from 74LV126A (3.3 V).

Figure 7-2. Equivalence Circuit (1/2)

(a) BUSY, PASS, ERROR, CANCEL, ENTER, NEXT

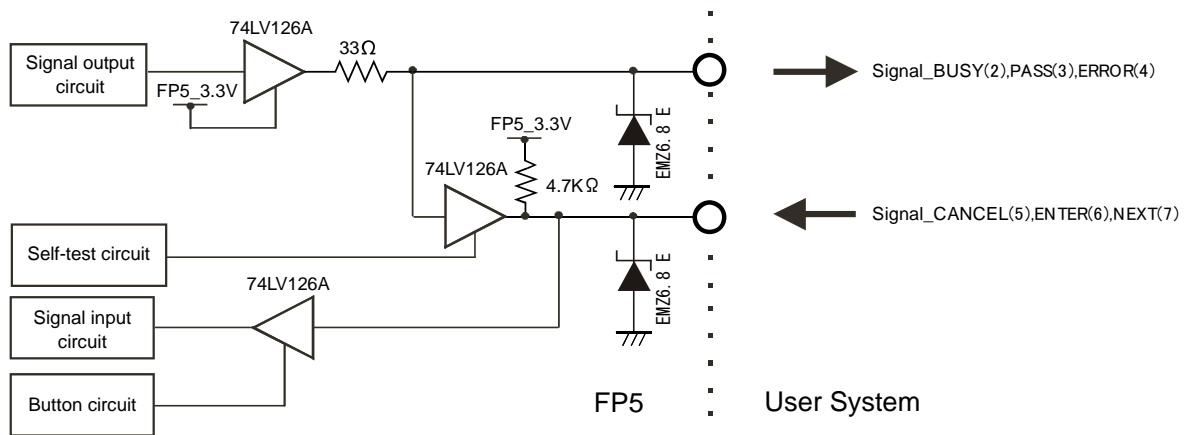

(b) CONN, VRF, START

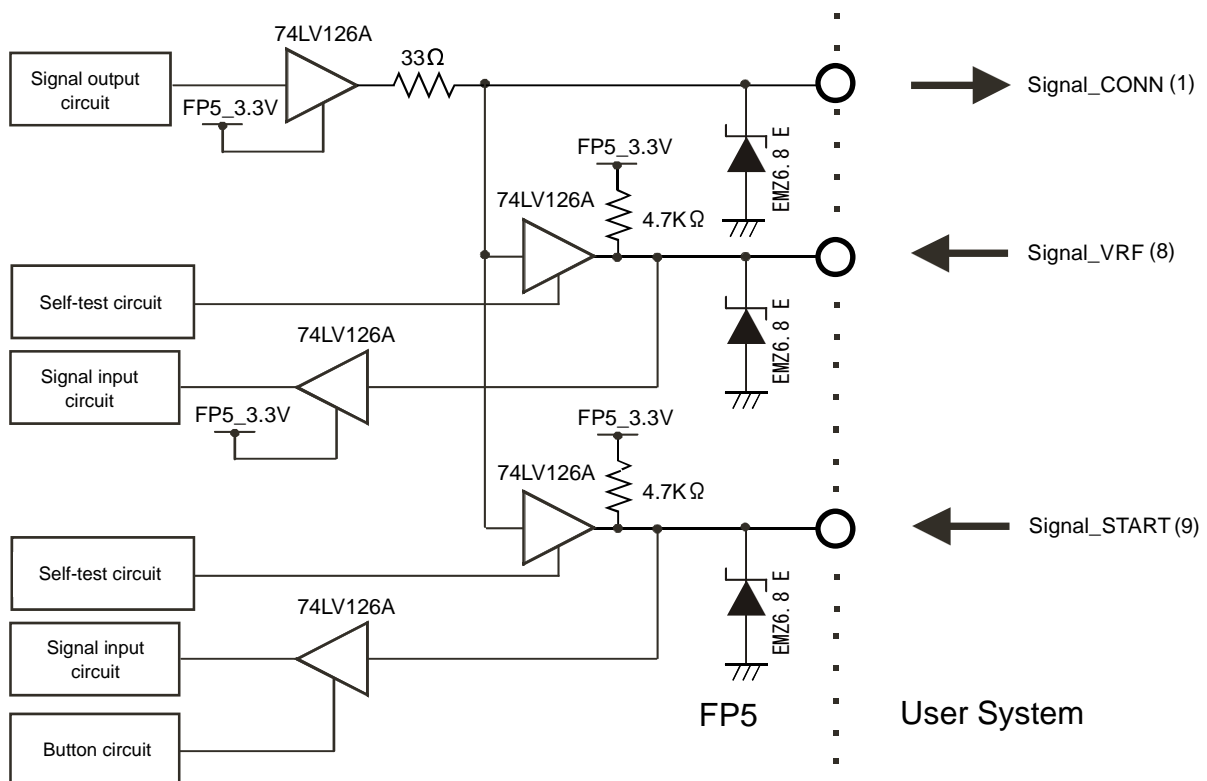
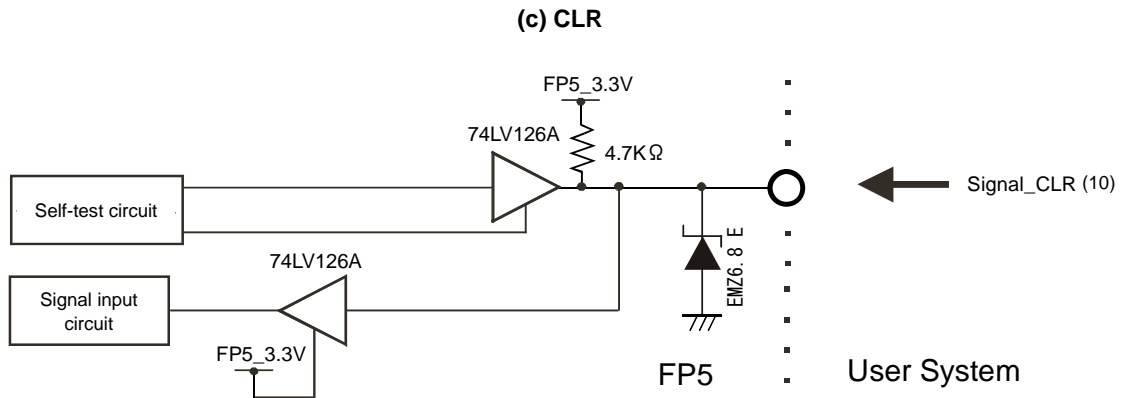

Figure 7-2. Equivalence Circuit (2/2)



7.4 External Connection Example

A connection example with a remote connector, external switch and LED is shown.

Figure 7-3. External Switch and LED Connection Example

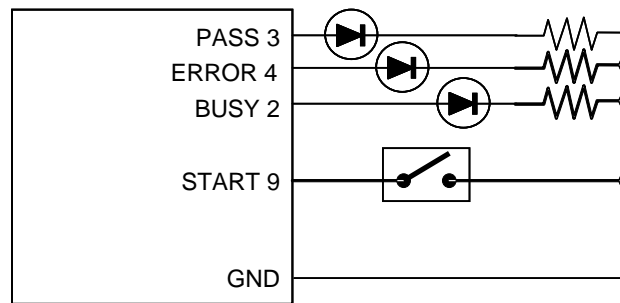

CHAPTER 8 USAGE COMMUNICATION COMMANDS

This chapter describes how to use communications commands from a host machine to operate the FP5.

8.1 Starting the Communications Software

In order to use communications commands for operation, communications with the FP5 must be established with communications software. In this chapter, we shall describe how to use HyperTerminal which is a part of Windows to establish communications.

(1) Connecting the system

Connect a serial cable to the serial port on your host machine, and then connect the other end to the serial connector on the FP5. Next, plug the AC adapter into an outlet, then connect it to the FP5 power supply connector.

Figure 8-1. System Connections

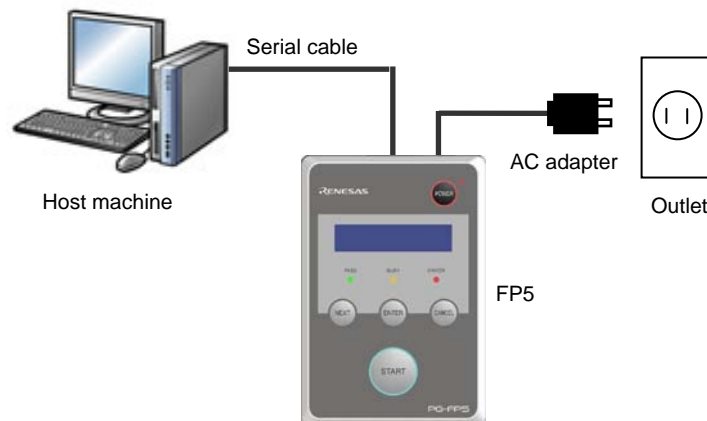

(2) Start the FP5

After the connections are made, press the FP5 **POWER** button to turn the power on. If the unit starts correctly, the POWER LED will light, and "Commands >" will be displayed on the message display.

If the unit does not come on in the manner described above, then there may be a malfunction in the FP5, so consult a Renesas Electronics sales representative or distributor.

(3) Start HyperTerminal

Click the Start menu "All Programs" -> "Accessories" -> "Communications" -> "HyperTerminal" to start it. The dialog box shown below will open. Input a name, then click the **OK** button.

Figure 8-2. Connection Settings



Next, the dialog box below will be displayed. From the "Connect using(N):" pull-down menu select the COM port which is in use. Check the COM port number with Device Manager.

Figure 8-3. Checking the COM Port Number Settings

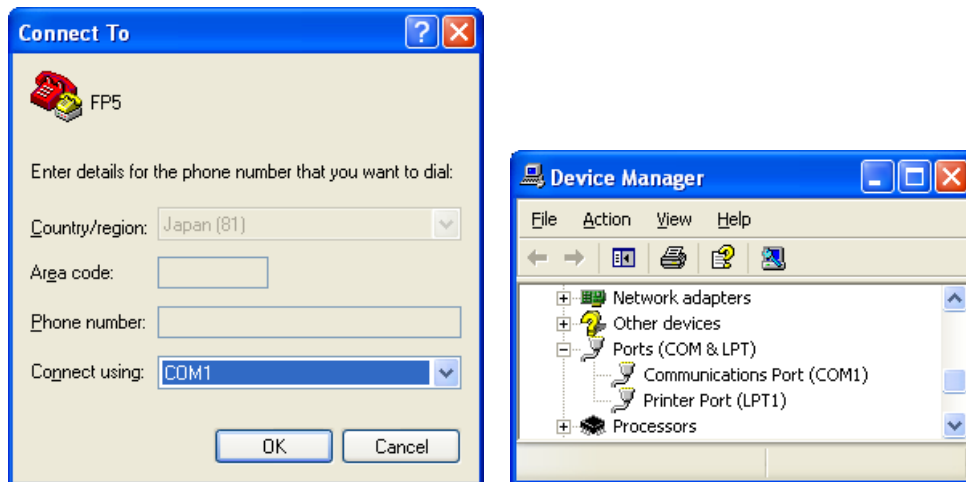

Next, the dialog box in Figure 8-4 will be displayed, so select the data transfer conditions listed below.

- Data transfer rate: 9600 bps, 19200 bps, 38400 bps, 57600 bps, 115200 bps
- Data bits: 8 bit
- Parity: None
- Stop bit: 1 bit
- Flow control: Hardware

The default data transfer rate is 9600 bps, but it may be changed by the programming GUI or terminal commands to another rate. In such cases, use the [Setup host connection...] in the programming GUI [Programmer] menu to check the transfer rate and make sure they match.

Figure 8-4. COM Port Settings

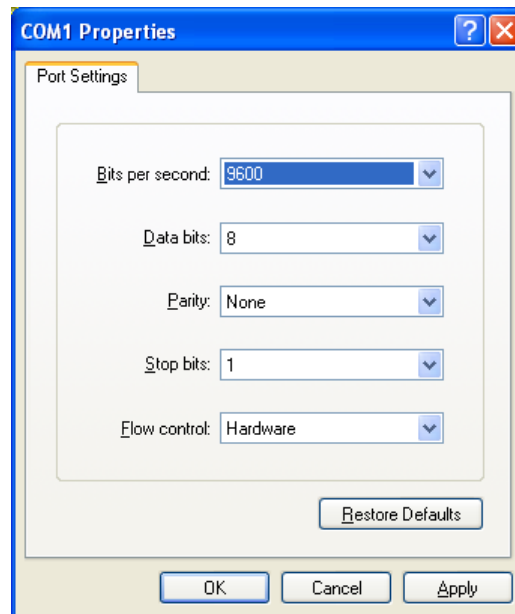

When HyperTerminal starts correctly, the main window will open. If communications are established, then a ">" will be displayed when the Enter key on the host machine is pressed. This completes the preparation for using communications commands.

Caution Press the Enter key once after FP5 has started. Alternatively, send a linefeed code once to FP5 by using communication software.

Figure 8-5. HyperTerminal Startup Screen

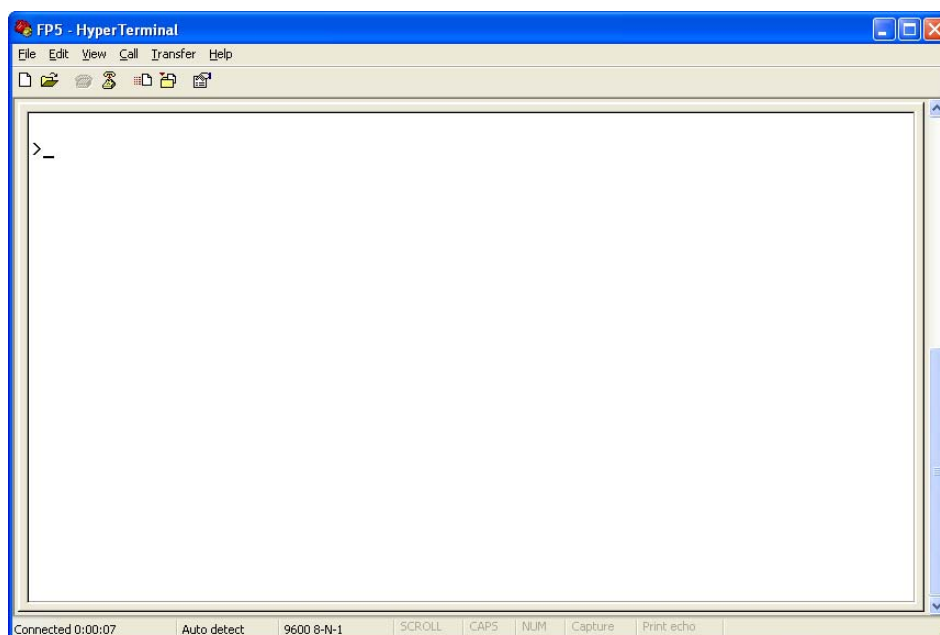

8.2 Command List

The following is a list of FP5 control commands and device commands.

Table 8-1. List of FP5 Control Commands

Command name	Description
autocon	Selects and confirms automatic or manual execution of the processes, from “transition to flash memory programming mode” to “signature verification”, and “the termination of the flash memory programming mode”.
brt	Confirms and changes the data transfer rate during serial communication with the host machine.
conf	Displays a list of the information stored in the FP5 and changes the number of programming area sections.
dwnprm	Downloads the PR5 file.
downset	Downloads the ESF file.
fcks	Executes the programming GUI [File] menu -> [Checksum...] command.
files	Displays the information concerning the program file that was downloaded to the FP5.
fpga_up	Updates the FPGA.
hex	Uploads the program file in Intel HEX format.
hlp	Displays a list of available commands, with simple descriptions.
lod	Downloads the program file.
prm	Displays the information concerning the PR5 file and ESF file that were downloaded to the FP5.
progarea	Confirms, changes and deletes data in the valid programming areas.
pwr_off	Turns off the FP5 power supply.
res	Resets the FP5.
security	Confirms the security state that can be set by the [FP5 Manager] command.
selftest	Executes a self-test.
sound	Sets the buzzer.
srec	Uploads the program file in Motorola HEX format.
trc	Displays the communication information between the FP5 and target device.
upprm	Uploads the PR5 file.
upset	Uploads the ESF file.
ver	Displays the FP5 version and FP5 mode.
version_up	Updates the firmware.

Table 8-2. List of FP5 Device Commands

Command name	Description
bln	Executes the [Blank check] command.
con	Executes the processes from “transition to flash memory programming mode” to “signature verification”.
dcon	Executes the termination of the flash memory programming mode.
ep or epv	Executes the [Autoprocedure (E.P.)] command.
ers	Executes the [Erase] command.
gid	Obtains the on-chip debug security ID get for the target device.
gob	Obtains the information of option byte get for the target device.
gos	Obtains the information of flash option get for the target device.
gsc	Obtains the information of security get for the target device.
idc	Executes the [Set OCD Security ID] command.
opb	Executes the [Set Option bytes] command.
prg	Executes the [Program] command.
read	Executes the [Read] command.
<R> scf	Executes the [Set Security] command.
sig	Executes the [Signature read] command.
<R> slb	Executes the [Set Lock bits] command.
sum	Executes the programming GUI [Device] menu -> [Checksum] command.
vrf	Executes the [Verify] command.

8.3 Description of Commands

Each of the commands is described using the following format.

Command name

Presents an overview of the command.

Input format

Presents the input format for the command^{Note}.

Description of the function

Describes the function of the command.

Example of usage

Presents an example of using the command.

Note The symbols used to describe the input format are defined below.

Notation	Description
Characters within single quotation marks ' '	Characters that must be input as displayed
Characters within angle brackets < >	Information that must be provided
Characters within parentheses ()	Optional items
Options separated by vertical bars	Options where only one option can be selected

8.4 Description of FP5 Control Commands

This section will describe the FP5 control commands.

8.4.1 autocon command

Selects and confirms automatic or manual execution of the processes, from “transition to flash memory programming mode” to “signature verification”, and “the termination of the flash memory programming mode”.

Input format

'autocon' ('on | off')

Description of the function

Selects either automatic (on) or manual (off) execution, to be executed before and after the device command completion, of the processes from “transition to the flash memory programming mode” to “signature verification (con command)”, and “termination of the flash memory programming mode (dcon command)”. The initial value is automatic (on). If this command is executed without an option, the current status is displayed (automatic (on) or manual (off)). The default setting is automatic (on).

on: The con command and dcon command are executed automatically.

off: The con command and dcon command are executed manually. When set to manual (off), the con command is executed, then the device command can be executed. Furthermore, various device commands can be executed multiple times. Execute the dcon command to terminate. Note that the ep (epv) command will automatically execute the con command and dcon command even if this is set to manual (off).

Example of usage

Command	Screen output
autocon	AutoCon is on / off
autocon on	AutoCon is on
autocon off	AutoCon is off

8.4.2 brt command

Confirms and changes the data transfer rate for serial communication with the host machine.

Input format

'brt' ('9600' | '19200' | '38400' | '57600' | '115200')

Description of the function

This command can be used with its options to change the data transfer rate for serial communications with the host machine. When the data transfer rate is changed, it will be necessary to change the data transfer rate of the COM port setting with HyperTerminal and reconnect.

If no options are used with this command, then the current data transfer rate will be displayed.

If the serial connector is connected, then the data transfer rate will be displayed.

If a USB connector is used, then the USB version will be displayed.

- USB (HS) ... USB 2.0
- USB (FS) ... USB 1.1

The default data transfer rate is 9600 bps.

- 9600: Changes the data transfer rate to 9600 bps.
- 19200: Changes the data transfer rate to 19200 bps.
- 38400: Changes the data transfer rate to 38400 bps.
- 57600: Changes the data transfer rate to 57600 bps.
- 115200: Changes the data transfer rate to 115200 bps.

Example of usage

Command	Screen output
brt	[When the serial connector is connected at 115200 bps] Current Baudrate is: 115200 [When the USB connector is connected at High speed] Current Baudrate is: USB (HS)
brt 9600	New Baudrate is: 9600
brt 19200	New Baudrate is: 19200
brt 38400	New Baudrate is: 38400
brt 57600	New Baudrate is: 57600
brt 115200	New Baudrate is: 115200

8.4.3 conf command

Displays a list of the information stored in the FP5 and changes the number of programming area sections.

Input format

'conf' ('progarea' '4x4' | '8x2')

Description of the function

Divides the programming area into eight or four areas depending on the selected option.

If an option is not specified, then the following information stored in the FP5 will be displayed.

- Version information (firmware version, board hardware version, FPGA version, serial number, FP5 mode)
- Program area information (area divisions, valid programming areas, maximum size of program file information (code area, data area))
- Program file information (file name, creation date, size, checksum)
- PR5 file and ESF file information in all programming areas (PR5 file names, PR5 file checksums, ESF file checksums)
- Automatic connection information
- Buzzer information
- Automatic power supply OFF information
- Security mode information
- FP5 manager option setting information

Progarea: Used to specify the number of programming area sections.

4x4: Divides the programming area into four sections.

8x2: Divides the programming area into eight sections.

Example of usage

Refer to the following pages.

(1/2)

Command	Screen output
conf progarea 4x4	<pre> [If there are four sections before the command is executed] OK INFO: Same setting. Configuration is not changed. [If there are eight sections before the command is executed] OK INFO: New configuration has been set. INFO: Progarea data is not valid any more. Number of Program areas: 4 Active Program Area: 0 Size of Program Areas (Code / Data): Area 0: 0x400000 / 0x020000 Area 1: 0x400000 / 0x020000 Area 2: 0x400000 / 0x020000 Area 3: 0x400000 / 0x020000 Area Filename Date Time Range CRC *0 {unknown data} 1 {unknown data} 2 {unknown data} 3 {unknown data} Checking Progareas..... No invalid data found. </pre>

(2/2)

Command	Screen output
conf	See below.
	<pre> Firmware Version Vx.xx Board H/W Vx, FPGA Vx Serial No.: xxxxxxxxxx Standard mode unsecured Number of Program areas: 4 Active Program Area: 0 Size of Program Areas (Code / Data): Area 0: 0x400000 / 0x020000 Area 1: 0x400000 / 0x020000 Area 2: 0x400000 / 0x020000 Area 3: 0x400000 / 0x020000 Area Filename Date Time Range CRC *0 sample.hex 2006-02-24 21:13 000000-007FFF 61D5F67C 1 {unknown data} 2 {unknown data} 3 {unknown data} Checking Progareas..... No invalid data found. Area Parameter file PR5 CRC ESF CRC *0 78F1166 C8005840 D0401B9D 1 {invalid} 2 {invalid} 3 {invalid} AutoCon is off Sound is on AutoPowerOff is disabled Security state is: Inactive Authorization procedure is: Undefined Manager option byte: 0x00 HEX file Upload enabled Device Setup enabled Checksum comparison off Reset option Hi-z </pre>

8.4.4 downprm command

Downloads the PR5 file.

Input format

'downprm'

Description of the function

Downloads the PR5 file. After this command is executed, the PR5 file must be downloaded to the FP5 in ASCII format using communications software. If using HyperTerminal, select Transfer(T) -> Transfer text file(T)..., and then select the PR5 file.

Example of usage

Command	Status	Status LED	Message display	Screen output
downprm	Display after execution of the command (before downloading)	BUSY	*** BUSY ***	Now loading...
	Display during downloading	BUSY	*** BUSY ***	...
	Display after normal ending of the download	PASS	Returns to the display before executing the command.	PASS
	Display after error ending of the download	ERROR	Returns to the display before executing the command.	ERROR: <text>

8.4.5 downset command

Downloads the ESF file.

Input format

'downset'

Description of the function

Downloads the ESF file. After this command is executed, the ESF file must be downloaded to the FP5 in ASCII format using communications software. If using HyperTerminal, select Transfer(T) -> Transfer text file(T)..., and then select the ESF file.

Example of usage

Command	Status	Status LED	Message display	Screen output
downset	Display after execution of the command (before downloading)	BUSY	*** BUSY ***	Now loading...
	Display during downloading	BUSY	*** BUSY ***	...
	Display after normal ending of the download	PASS	Returns to the display before executing the command.	PASS
	Display after error ending of the download	ERROR	Returns to the display before executing the command.	ERROR: <text>

8.4.6 fcks command

Executes the programming GUI [File] menu -> [Checksum...] command.

Input format

'fcks' <type> <(code)start> <(code)end> (<data_start> <data_end>)

Description of the function

Executes a similar function to the programming GUI [File] menu -> [Checksum...] command.

Specifies the calculation method, starting address and number of bytes in the options.

- type: Specifies the calculation method.
- crc: 32-bit CRC method
 - ari: 16-bit subtraction calculation method
 - k0s_sp: Division method (original)
- start: The starting address is specified in hexadecimal. If a PR5 file that supports data flash is downloaded, then the code area and data area can be specified.
- end: Specifies the end address in hexadecimal. If a PR5 file that supports data flash is downloaded, then the code area and data area can be specified.

Example of usage

Command	Screen output
fcks crc 0 3ffff	Checksum Code : 000000-3FFFFFF = 26218DD4
fcks ari 0 3ffff	Checksum Code : 000000-3FFFFFF = 61C0
fcks k0s_sp 0 3ffff	Checksum Code : 000000-3FFFFFF = 060E
fcks ari 0 3ffff 400000 41ffff	Checksum Code : 000000-3FFFFFF = 61C0 Checksum Data : 400000-41FFFF = 0200 Checksum Total : 63C0

8.4.7 files command

Displays the information concerning the program file that was downloaded to the FP5.

Input format

'files' ('check')

Description of the function

If no options are used, then information (file name, creation date, size, checksum) concerning the program file downloaded to the FP5 is displayed.

check: The checksum of all programming areas stored in the program file, from START to END, is recalculated with the 32-bit CRC method, and cross-checked with the checksum stored in the FP5 during download.

Example of usage

Command	Screen output
Files	<pre> Area Filename Date Time Range CRC *0 sample.hex 2006-02-24 21:13 000000-007FFF 61D5F67C 1 {unknown data} 2 {unknown data} 3 {unknown data} </pre>
files check	<pre> Area Filename Date Time Range CRC *0 sample.hex 2006-02-24 21:13 000000-007FFF 61D5F67C 1 {unknown data} 2 {unknown data} 3 {unknown data} Checking Progareas..... No invalid data found. </pre>

8.4.8 fpga_up command

Updates the FPGA.

Input format

'fpga_up'

Description of the function

Updates the FPGA version. After this command is executed, the FPGA file must be downloaded to the FP5 in ASCII format using communications software. If using HyperTerminal, select Transfer(T) -> Transfer text file(T)..., and then select the FPGA file. After the FPGA version has been updated, the FP5 power supply will be automatically turned off.

Example of usage

Command	Status	Status LED	Message display	Screen output
fpga_up	Display after executing the command (before downloading) Press y to continue. Press n to cancel.	Off	*** BUSY ***	Are you sure, you want to update the FPGA (y/n)?
	Display after pressing y	Off	*** BUSY ***	Preparing storage ...OK Now loading...
	Display during download	Off	*** BUSY ***	...
	Display after end of normal download Press y to continue. Press n to cancel.	Off	*** BUSY ***	Refer to <1> below.
	Display after pressing y	Off	Programming FPGA	Refer to <2> below.
<1> OK **** CAUTION **** Now the FPGA will be written. Please ensure that: - the correct FPGA Update file has been downloaded - the Power is NOT disconnected during this operation - the Programmer is NOT reset during this operation Do you want to continue (y/n)?				
<2> Starting FPGA programming... 100% done FPGA Update succeeded. PG-FP5 Power will be switched OFF now....				

8.4.9 hex command

Uploads the program file in Intel HEX format.

Input format

'hex' ((<code_start address> <code_length>) (<data_start address> <data_length>))

Description of the function

If a program file has been downloaded to a valid programming area, executing this command will upload the program file in Intel HEX format. If this command is executed without any options, the upload will be executed with the address size used during downloading. If a program has not been downloaded, then "Invalid argument" will be displayed. The starting address and number of bytes are designated as options.

start address: The starting address is designated as a hexadecimal number. If a PR5 file that support data flash has been downloaded, then the code area and data area are designated.

length: The number of bytes is designated as a hexadecimal number. If a PR5 file that support data flash has been downloaded, then the code area and data area are designated.

Example of usage

Command	Screen output
hex	Press 'return' to start/continue output.
hex 0 3fff	Press 'return' to start/continue output.
hex 0 3fff 400000 20000	Press 'return' to start/continue output.
After the command is executed, pressing the Return key will start the upload. See below. :200000008100D0 :200020008100FFF33 : :00000001FF	

8.4.10 hlp command

Lists available commands with brief descriptions.

Input format

'hlp'

Description of the function

Lists frequently-used commands with brief descriptions.

Example of usage

Command	Screen output
hlp	See below.
<pre> ----- Control commands ----- downprm/downset : Download parameter/customer settings upprm /upset : Upload parameter/customer settings lod : Download Intel Hex or Motorola S-record file hex/srec : Upload Intel Hex / Motorola S-record file progarea : Change Program area files : Show downloaded HEX/SREC files in FP5 memory prm : Show Parameter file (PRM/SET) information conf : Show / Modify FP5 configuration security : Show / Modify FP5 Security settings brt : Set baudrate to host fcks : Calculate file checksum (FP5 memory) fill : Fill memory ver : Show firmware version res : Reset FP5 pwr_off : Switch OFF FP5 immediately / set auto Power OFF sound : Enable / Disable sound generation trc : Show Device communication trace version_up : Update firmware version fpga_up : Update FPGA version selftest : Perform a Selfcheck ----- Device commands ----- bln : Blankcheck ers : Erase prg : Program vrf : Verify read : Read ep : Erase and Program sig : Show device signature sum : Get device checksum scf : Set security information </pre>	

8.4.11 lod command

Downloads program files.

Input format

'lod' ('add') ('fname="filename") ('ftime="date and time")

Description of the function

Downloads the program file to a valid programming area. After this command is executed, the program file must be downloaded to the FP5 in ASCII format using communications software. If using HyperTerminal, select Transfer(T) -> Transfer text file(T)..., and then select the program file. The options are to delete or not to delete the file before downloading, the file name, and the creation date. If this command is executed without any options, then the file name and creation date will not be stored.

add

Select this not to delete the data in the valid programming area before downloading program files. When this is not designated, the data will be deleted. Please use this option when downloading and writing two program files. Usually, this is not designated.

Note When this option is enabled and the lod command is executed, the PG-FP5 downloads data 512 bytes at a time without erasing its internal flash memory. Note, however, that the download error “ERROR: NAND flash – Illegal Write (Bit 0->1)” occurs if there is data other than FFh in the data being downloaded.

fname = “filename”

Designates the file name of the program file that is downloaded. The maximum number of characters is 31.

ftime = “date and time”

Designates the creation date and time of the downloaded program file. The format is YYYY-MM-DD HH:MM.

YYYY: Year; MM: Month; DD: Date; HH: Hour; MM: Minute

Example of usage

Command	Status	Status LED	Message display	Screen output
lod	Display after execution of the command (before downloading)	BUSY	*** BUSY ***	Preparing storagePASS Now loading...
	Display during downloading	BUSY	*** BUSY ***	...
	Display after normal ending of the download	PASS	Returns to the display before executing the command.	PASS
	Display after error ending of the download	ERROR	Returns to the display before executing the command.	ERROR: <text>
Address range: 0x000000 to 0x007FFF, CRC32: 0x61D5F67C				
PASS				

Command	Operation
lod fname="sample.hex" ftime="2006-02-24 21:13"	Same operation as lod
lod add	Same operation as lod

8.4.12 prm command

Displays the information concerning the PR5 file and ESF file that were downloaded to the FP5.

Input format

'prm'

Description of the function

Displays the information concerning the PR5 file and ESF file (PR5 file name, PR5 checksum, ESF file checksum) that were downloaded to all the programming areas of the FP5.

Example of usage

Command	Screen output			
prm	Area	Parameter file	PR5 CRC	ESF CRC
	*0	78F1166	C8005840	D0401B9D
	1	{invalid}		
	2	{invalid}		
	3	{invalid}		

8.4.13 progarea command

Confirms, changes and deletes data from valid programming areas.

Input format

'progarea' ('clear' | ('0' | '1' | '2' | '3' | '4' | '5' | '6' | '7'))

Description of the function

The valid programming area can be changed by designating a numerical option. Also, by designating the clear option, the data in the valid programming area (PR5 file, ESF file, and program file) can be deleted. If there are no options, then the current valid programming area is displayed.

clear: Clears the data in the valid programming area (PR5 file, ESF file, and program file).

0: Changes the valid programming area to 0.

1: Changes the valid programming area to 1.

2: Changes the valid programming area to 2.

3: Changes the valid programming area to 3.

Example of usage

Command	Screen output
progarea	Active Program Area: 0 Max. program size: 4 MByte Max. data size: 128 kByte
progarea clear	Invalid character. Invalid argument.
progarea 0	Active Program Area: 0

8.4.14 pwr_off command

Turns off the FP5 power supply.

Input format

'pwr_off' ('now' | 'auto' ('off' | <time [minutes]>))

Description of the function

Turns off the FP5 power supply. Adjusts the off timing by designating the options. If options are not used, then the user can see if automatic power supply off is enabled or disabled.

now: Turns off the power supply immediately.

auto: After the designated time has elapsed, automatic power supply off is enabled. Once this is designated, even if the automatic power supply turns off, it will still be enabled if set to ON.

off: After the designated time has elapsed, automatic power supply off is disabled.

time: Designates the automatic power supply off time. The time can be 1 to 35791394 (in minutes). Note that 1 to 4 are set to 5 minutes.

Example of usage

Command	Screen output
pwr_off	AutoPowerOff is disabled
pwr_off now	PG-FP5 Power will be switched OFF now....
pwr_off auto 10	AutoPowerOff is enabled, time is 10 min.

8.4.15 res command

Resets FP5.

Input format

'res'

Description of the function

Executes a function similar to the programming GUI [Programmer] menu -> [Reset] command.

Example of usage

Command	Screen output
res	<pre> FFFFFFFF P P P P P 555555 F P P 5 F P P 5 F P P 55555 FFFFF P P P P P 5 F P P 5 F P P 5 F P 5 5 F P P 5555 </pre> <p>Firmware Version Vx.xx Board H/W Vx, FPGA Vx Serial No.:xxxxxxxxx Standard mode unsecured</p>

8.4.16 security command

Confirms the security state that can be set by the [FP5 Manager] command.

Input format

'security'

Description of the function

Confirms the security state that can be set by the [FP5 Manager] command.

Example of usage

Command	Screen output
security	<pre> [When password-protection is valid] Security state is: Locked Authorization procedure is: Password [When password-protection is invalid] Security state is: Inactive Authorization procedure is: Undefined </pre>

8.4.17 selftest command

Executes a self-test.

Input format

'selftest'

Description of the function

Executes a function similar to the programming GUI [Programmer] menu -> [Self-Test] command.

Example of usage

Command	Screen output
selftest	***** CAUTION ***** Remove any plugs from Target- and Remote-Connector before starting. Any hardware attached to those connectors may be damaged by this test ! ***** CAUTION ***** Target- and Remote-connector unplugged ? If yes, press 's' to start the test: s FPGA Test: PASS Power Supply Test: PASS Target- and Remote-Interface Test: PASS Selftest PASSED.

8.4.18 sound command

Sets the buzzer.

Input format

'sound' ('off' | 'on')

Description of the function

Sets the buzzer. "Enabled" or "disabled" is optionally designated. If no option is designated, the current setting is displayed.

off: Disables the buzzer.

on: Enables the buzzer.

Example of usage

Command	Screen output
sound	Sound is on
sound off	Sound is off

8.4.20 trc command

Displays the communication information between the FP5 and target device.

Input format

'trc'

Description of the function

Displays the communication information between the FP5 and target device stored in the FP5 trace memory. Up to 1024 lines can be stored.

The FP5 has ring structure trace memory.

Example of usage

Command	Screen output
trc	See below.
Debug Output	
Number Time us Send Rec.	
:	
0214 0008675924 17 --	
0215 0008678930 -- 02	
:	
Total number of transmitted bytes : 266282	
Total number of received bytes : 006212	

8.4.21 upprm command

Uploads the PR5 file.

Input format

'upprm'

Description of the function

If the PR5 file has been downloaded to a valid programming area, then executing this command will upload the PR5 file.

Example of usage

Command	Screen output
upprm	Press 'return' to start/continue output.
After the command is executed, pressing the Return key will start the upload. See below. [FlashProParameterFile] : [CHECKSUM] SUM=BA9F0491 [EOF]	

8.4.22 upset command

Uploads the ESF file.

Input format

'upset'

Description of the function

If the ESF file has been downloaded to a valid programming area, then executing this command will upload the ESF file.

Example of usage

Command	Screen output
upset	Press 'return' to start/continue output.
After the command is executed, pressing the Return key will start the upload. See below.	
[FlashproCustomerSettingFile]	
:	
[CHECKSUM]	
SUM=F7D4A9E7	
[EOF]	

8.4.23 ver command

Displays the FP5 version.

Input format

'ver'

Description of the function

Displays the FP5 version (firmware version, board hardware version, FPGA version, and serial number).

Example of usage

Command	Screen output
ver	Firmware Version Vx.xx Board H/W Vx, FPGA Vx Serial No.:xxxxxxxxx Standard mode unsecured

8.4.24 version_up command

Updates the firmware.

Input format

'version_up'

Description of the function

Upgrades the firmware. After this command is executed, the firmware file must be downloaded to the FP5 in ASCII format using communications software. If using HyperTerminal, select Transfer(T) -> Transfer text file(T)..., and then select the firmware file. After the firmware version has been updated, the FP5 will be reset.

Example of usage

Refer to the following pages.

Command	Status	Status LED	Message display	Screen output
version_up	Display after executing the command (before downloading) Press y to continue. Press n to cancel.	Off	*** BUSY ***	Are you sure, you want to update the Firmware (y/n)?
	Display after pressing y	Off	*** BUSY ***	Preparing storage ...OK Now loading...
	Display during download	Off	*** BUSY ***	...
	Display after end of normal download Press y to continue. Press n to cancel.	Off	*** BUSY ***	Refer to <1> below.
	Display after pressing y	Off	Selfprogramming Firmware	Refer to <2> below.
<p><1> OK</p> <p>**** CAUTION ****</p> <p>Now the Firmware will be written. Please ensure that:</p> <ul style="list-style-type: none"> - the correct Firmware Update file has been downloaded - the Power is NOT disconnected during this operation - the Programmer is NOT reset during this operation <p>Do you want to continue (y/n)?</p>				
<p><2></p> <p>FP5 Selfprogramming Vx.xx Checking FLMD0 level.. OK. Erase flash.. OK. Blank check.. OK. Write flash..... OK. Margin check.. OK. Verify..... OK. Firmware Update succeeds.</p> <p>Restarting FP5..</p> <pre> FFFFFFFF P P P P P 555555 F P P P 5 F P P P 5 F P P P 55555 FFFFF P P P P P 5 F P 5 F P 5 F P 5 5 F P 5555 </pre> <p>Firmware Version Vx.xx Board H/W Vx, FPGA Vx Serial No.:xxxxxxxxx Standard mode unsecured</p>				

8.5 Description of The FP5 Device Commands

This section describes the FP5 device commands.

8.5.1 bIn command

Executes [Blank check] command.

Input format

'bIn'

Description of the function

Executes a similar function to the programming GUI [Device] menu -> [Blank check] command.

Example of usage

Command	Status	Status LED	Message display	Screen output
bIn	Display while executing the command [Chip mode]	BUSY	Blank chk. Chip ...	Blank check Chip:
	Display while executing the command [Block mode]	BUSY	Blank chk. Block ...	Blank check Block sss to eee: or Blank check Block 000: Blank check Block 001: : Blank check Block eee:
	Display while executing the command [Area mode]	BUSY	Blank chk. Area ...	Blank check Area 000: Blank check Area 001: : Blank check Area eee:
	Display after executing the command [For blank devices]	PASS	Returns to the display before executing the command.	PASS Blank check operation finished.
	Display after executing the command [For not blank devices]	ERROR	ERROR: 051 Blank chk failed	ERROR(E051): Not Blank. Blank check operation finished.

8.5.2 con command

Executes the processes from “transition to the flash memory programming mode” to “signature verification”.

Input format

'con'

Description of the function

Executes the processes from “transition to the flash memory programming mode” to “signature verification”. In order to use this command, “manual” (off) must be set with the autocon command beforehand.

Example of usage

Command	Status	Status LED	Message display	Screen output
con	Display while executing the command	BUSY	Connecting:	
	Display after executing the command [When completed normally]	PASS	Returns to the display before executing the command.	PASS Dxxxxxxx>
	Display after executing the command [When terminated abnormally]	ERROR	ERROR: xxx xxxxxxxxxxxxxxxxxx	ERROR(Exxx): <text>

8.5.3 dcon command

Executes the process to end the flash memory programming mode.

Input format

'dcon'

Description of the function

Executes the process to end the flash memory programming mode. In order to use this command, "manual" (off) must be set with the autocon command beforehand.

Example of usage

Command	Status	Status LED	Message display	Screen output
con	Display while executing the command	BUSY	Disconnecting:	
	Display after executing the command	PASS	Returns to the display before executing the command.	Device disconnected.

8.5.4 ep/epv command

Executes [Autoprocedure(E.P.)] command.

Input format

'ep' or 'epv'

Description of the function

Executes a similar function to the programming GUI [Device] menu -> [Autoprocedure(E.P.)] command.

Example of usage

Command	Status	Status LED	Message display	Screen output
ep or epv	Display while executing the command	BUSY		See below.
	Display after executing the command [When completed normally]	PASS	Returns to the display before executing the command.	PASS Erase,Program operation finished. or PASS EPV operation finished.
	Display after executing the command [When terminated abnormally]	ERROR	ERROR: xxx xxxxxxxxxxxxxxxx	ERROR(Exxx): <text> Erase,Program operation finished. or ERROR(Exxx): <text> EPV operation finished.
<p>[Display example]</p> <p>Blank check Skipped.</p> <p>Erase Chip:</p> <p>PASS</p> <p>Program Chip:</p> <p>10%</p> <p>20%</p> <p>:</p> <p>100%</p>				

8.5.5 ers command

Executes [Erase] command.

Input format

'ers'

Description of the function

Executes a similar function to the programming GUI [Device] menu -> [Erase] command.

Example of usage

Command	Status	Status LED	Message display	Screen output
ers	Display while executing the command [Chip mode]	BUSY	Erase Chip ...	Blank check Skipped. Erase Chip:
	Display while executing the command [Block mode]	BUSY	Erase Block ...	Blank check Skipped. Erase Block sss to eee: or Blank check Skipped. Erase Block 000: Erase Block 001: : Erase Block eee:
	Display while executing the command [Area mode]	BUSY	Erase Area ...	Blank check Skipped. Erase Area 000: Erase Area 001: : Erase Area eee:
	Display after executing the command [When completed normally]	PASS	Returns to the display before executing the command.	PASS Erase operation finished.
	Display after executing the command [When terminated abnormally]	ERROR	ERROR: xxx xxxxxxxxxxxxxxxx	ERROR(Exxx): <text> Erase operation finished.

8.5.6 gid command

Obtains the on-chip debug security ID get for the target device.

Input format

'gid'

Description of the function

Obtains the information set by executing the [Set OCD Security ID] command on the [Device] menu of the programming GUI.

Example of usage

Command	Status	Status LED	Message display	Screen output
gid	Display after executing the command [When completed normally]	PASS	Returns to the display before executing the command.	[Display example] OCD-ID : xxxxxxxxxxxxxxxxxxxxxxxx PASS OCD-ID operation finished.
	Display after executing the command [When terminated abnormally]	ERROR	ERROR: xxx xxxxxxxxxxxxxxxxxxxx	ERROR(Exxx): <text>

8.5.7 gob command

Obtains the information of option byte get for the target device.

Input format

'gob'

Description of the function

Obtains the information set by executing the [Set Option bytes] command on the [Device] menu of the programming GUI.

Example of usage

Command	Status	Status LED	Message display	Screen output
gob	Display after executing the command [When completed normally]	PASS	Returns to the display before executing the command.	[Display example] Option bytes : xxxxxxxx PASS Option Bytes operation finished.
	Display after executing the command [When terminated abnormally]	ERROR	ERROR: xxx xxxxxxxxxxxxxxxxxx	ERROR(Exxx): <text>

8.5.8 gos command

Obtains the information of flash option get for the target device.

Input format

'gos'

Description of the function

Obtains the information set by executing the [Get Flash options] command on the [Device] menu of the programming GUI.

Example of usage

Command	Status	Status LED	Message display	Screen output
gos	Display after executing the command [When completed normally]	PASS	Returns to the display before executing the command.	[Display example] Security Flag: xx Boot Block Number: xx FS area: xxxx - xxxx OCD-ID : xxxxxxxxxxxxxxxxxxxxxxxx Option Bytes : xxxxxxxx PASS Get Option Setting operation finished.
	Display after executing the command [When terminated abnormally]	ERROR	ERROR: xxx xxxxxxxxxxxxxxxxxxxx	ERROR(Exxx): <text>

8.5.9 gsc command

Obtains the information of security get for the target device.

Input format

'gsc'

Description of the function

Obtains the information set by executing the [Set Security] command on the [Device] menu of the programming GUI.

Example of usage

Command	Status	Status LED	Message display	Screen output
gsc	Display after executing the command [When completed normally]	PASS	Returns to the display before executing the command.	[Display example] Security Flag: xx Boot Block Number: xx FS area: xxxx – xxxx PASS Security operation finished.
	Display after executing the command [When terminated abnormally]	ERROR	ERROR: xxx xxxxxxxxxxxxxxxxxxxx	ERROR(Exxx): <text>

8.5.10 idc command

Executes the [Set OCD Security ID] command.

Input format

'idc'

Description of the function

Obtains the information set by executing the [Set OCD Security ID] command on the [Device] menu of the programming GUI.

Example of usage

Command	Status	Status LED	Message display	Screen output
idc	Display after executing the command [When completed normally]	PASS	Returns to the display before executing the command.	[Display example] Set OCD-ID PASS OCD-ID operation finished.
	Display after executing the command [When terminated abnormally]	ERROR	ERROR: xxx xxxxxxxxxxxxxxxx	ERROR(Exxx): <text>

8.5.11 opb command

Executes the [Set Option bytes] command.

Input format

'opb'

Description of the function

Obtains the information set by executing the [Set Option bytes] command on the [Device] menu of the programming GUI.

Example of usage

Command	Status	Status LED	Message display	Screen output
opb	Display after executing the command [When completed normally]	PASS	Returns to the display before executing the command.	[Display example] Set Option bytes PASS Option bytes operation finished.
	Display after executing the command [When terminated abnormally]	ERROR	ERROR: xxx xxxxxxxxxxxxxxxx	ERROR(Exxx): <text>

8.5.12 prg command

Executes [Program] command.

Input format

'prg'

Description of the function

Executes a similar function to the programming GUI [Device] menu -> [Program] command.

Example of usage

Command	Status	Status LED	Message display	Screen output
prg	Display while executing the command [Chip mode]	BUSY	Program Chip Addr: 0x000000	Program Chip: 10% 20% : 100%
	Display while executing the command [Block mode]	BUSY	Program Block Addr: 0x000000	Program Block sss to eee: 10% 20% : 100% or Program Block 000: 10% 20% : 100% Program Block 001: : Program Block eee:
	Display while executing the command [Area mode]	BUSY	Program Area Addr: 0x000000	Program Area 000: 10% 20% : 100% Program Area 001: : Program Area eee:
	Display after executing the command [When completed normally]	PASS	Returns to the display before executing the command.	PASS Program operation finished.
	Display after executing the command [When terminated abnormally]	ERROR	ERROR: xxx xxxxxxxxxxxxxxxx	ERROR(Exxx): <text> Program operation finished.

8.5.13 read command

Executes [Read] command.

Input format

'read' ('hex' | 'srec') (<start_address> <end_address>)

Description of the function

Executes a similar function to the programming GUI [Device] menu -> [Read] command.

hex: Executes [Read] with the Intel HEX format.

srec: Executes [Read] with the Motorola HEX format.

If neither hex nor srec is designated, then the [Read] will be executed in hexadecimal format.

start_address: Designates the starting address with a hexadecimal number.

end_address: Designates the ending address with a hexadecimal number.

If neither the start_address nor end_address options are used, then [Read] will be executed for the range set in the Operation mode. Use as the start address and end address the start address of an arbitrary block and the end address of an arbitrary block of the target device.

Example of usage

Command	Status	Status LED	Message display	Screen output
read	Display after executing the command	BUSY	Read	Press 'return' to start/continue output.
	Display after pressing the Return key	BUSY	Read Addr: 0x000000	See below.
	Display after [Read] ends [When completed normally]	PASS	Returns to the display before executing the command.	PASS Read operation finished.
	Display after [Read] ends [When terminated abnormally]	ERROR	ERROR: xxx xxxxxxxxxxxxxxxx	ERROR(Exxx): <text>
<pre> <In the case of read hex 0 1000> :10000000FFFFFFFFFFFFFFFFFFFFFFFFFFFFFFFF00 :10001000FFFFFFFFFFFFFFFFFFFFFFFFFFFFFFFF00 : :100FF000FFFFFFFFFFFFFFFFFFFFFFFFFFFFFFFF01 :00000001FF <In the case of read srec 0 1000> S0030000FC S31500000000FFFFFFFFFFFFFFFFFFFFFFFFFFFFFFFA S3150000010FFFFFFFFFFFFFFFFFFFFFFFFFFFFFFFEA : S3150000FF0FFFFFFFFFFFFFFFFFFFFFFFFFFFFFFFB S70500000000FA <In the case of read 0 1000> 000000: FF FF FF FF FF FF FF FF FF FF FF FF FF FF FF 000010: FF FF FF FF FF FF FF FF FF FF FF FF FF FF FF : 000FF0: FF FF FF FF FF FF FF FF FF FF FF FF FF FF FF </pre>				

8.5.14 scf command

<R> Executes [Set Security] command.

Input format

'scf'

Description of the function

<R> Executes a similar function to the programming GUI [Device] menu -> [Set Security] command.

Example of usage

Command	Status	Status LED	Message display	Screen output
scf	Display while executing the command	BUSY	Set Security Fla	Set Security Flags
	Display after executing the command [When completed normally]	PASS	Returns to the display before executing the command.	PASS Security operation finished.
	Display after executing the command [When terminated abnormally]	ERROR	ERROR: xxx xxxxxxxxxxxxxxxx	ERROR(Exxx): <text>

8.5.15 sig command

Executes [Signature read] command.

Input format

'sig'

Description of the function

Executes a similar function to the programming GUI [Device] menu -> [Signature read] command.

Example of usage

Command	Status	Status LED	Message display	Screen output
sig	Display while executing the command	BUSY	Signature:	<Display example> Device name: Dxxxxxxxx Device data: xx xx xx xx Device end addr: xxxxxxxx Security Flag: xxxx Boot Block Number: xxxx Device Version: x.xx Firmware Version: x.xx
	Display after executing the command [When completed normally]	PASS	Returns to the display before executing the command.	PASS Signature operation finished.
	Display after executing the command [When terminated abnormally]	ERROR	ERROR: xxx xxxxxxxxxxxxxxxxxxxx	ERROR(Exxx): <text>

<R> 8.5.16 slb command

Executes [Set Lock bits] command.

Input format

'slb'

Description of the function

Executes a similar function to the programming GUI [Device] menu -> [Set Lock bits] command.

The lock bit setting is according to the setting saved in the ESF file.

Example of usage

Command	Status	Status LED	Message display	Screen output
slb	Display after executing the command [When completed normally]	PASS	Returns to the display before executing the command.	<Display example> Set LockBits PASS LockBits operation finished.
	Display after executing the command [When terminated abnormally]	ERROR	ERROR: xxx xxxxxxxxxxxxxxxx	ERROR(Exxx): <text>

8.5.17 sum command

Executes the programming GUI [Device] menu -> [Checksum] command.

Input format

'sum' (<start_address> <end_address>))

Description of the function

Executes a similar function to the programming GUI [Device] menu -> [Checksum] command.

start_address: Designates the starting address as a hexadecimal number.

end_address: Designates the ending address as a hexadecimal number.

<R> If the start_address and end_address options are not used, [Checksum (C)] is executed for the range specified in the operation mode. Set the start address and end address to the start address of a block and the end address of a block of the target device, respectively.

Example of usage

Command	Status	Status LED	Message display	Screen output
sum	Display while executing the command	BUSY	Checksum:	
	Display after executing the command [When completed normally]	PASS	Checksum: xxxx	0xxxxx PASS Checksum operation finished.
	Display after executing the command [When terminated abnormally]	ERROR	ERROR: xxx xxxxxxxxxxxxxxxx	ERROR(Exxx): <text>

8.5.18 vrf command

Executes [Verify] command.

Input format

'vrf'

Description of the function

Executes a similar function to the programming GUI [Device] menu -> [Verify] command.

Example of usage

Command	Status	Status LED	Message display	Screen output
vrf	Display while executing the command [Chip mode]	BUSY	Verify Chip Addr: 0x000000	Verify Chip: 10% 20% : 100%
	Display while executing the command [Block mode]	BUSY	Verify Block Addr: 0x000000	Verify Block sss to eee: 10% 20% : 100% or Verify Block 000: 10% 20% : 100% Verify Block 001: : Verify Block eee:
	Display while executing the command [Area mode]	BUSY	Verify Area Addr: 0x000000	Verify Area 000: 10% 20% : 100% Verify Area 001: : Verify Area eee:
	Display after executing the command [When completed normally]	PASS	Returns to the display before executing the command.	PASS Verify operation finished.
	Display after executing the command [When terminated abnormally]	ERROR	ERROR: xxx xxxxxxxxxxxxxxxx	ERROR(Exxx): <text> Verify operation finished.

CHAPTER 9 CONNECTORS AND CABLES

9.1 Power Supply Connector

The power supply connector is laid out on the host interface side of the FP5.

Figure 9-1. Power Supply Connector <FP5 Host Interface Side>

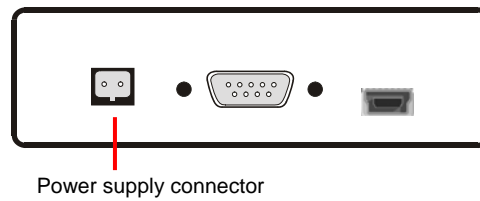
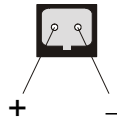

Figure 9-2. Power Supply Connector Pin Assignment



Caution Do not connect an AC adapter other than the one for the PG-FP5 to the power supply connector.

9.2 Serial Connector

The serial connector (9-pin D-SUB male connector) is laid out on the host interface side of the FP5.

Figure 9-3. Serial Connector <FP5 Host Interface Side>

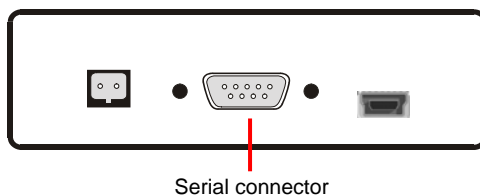

Figure 9-4. Serial Connector Pin Assignment

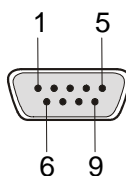

Table 9-1. Serial Connector Pin Configuration

Serial Connector	Signal Name
1	NC
2	RxD
3	TxD
4	NC
5	V _{SS}
6	NC
7	RTS
8	CTS
9	NC

Remark Part number of serial connector (9-pin D-SUB male connector): 070430MB009G200ZU (Suyin Connector Corp.)

9.2.1 Serial cable

The host cable is a standard shielded serial cable (crossed) approximately 3 meters long. The connectors on both sides are 9-pin D-SUB female connectors. The following shows the connection.

Figure 9-5. Serial Cable Connection

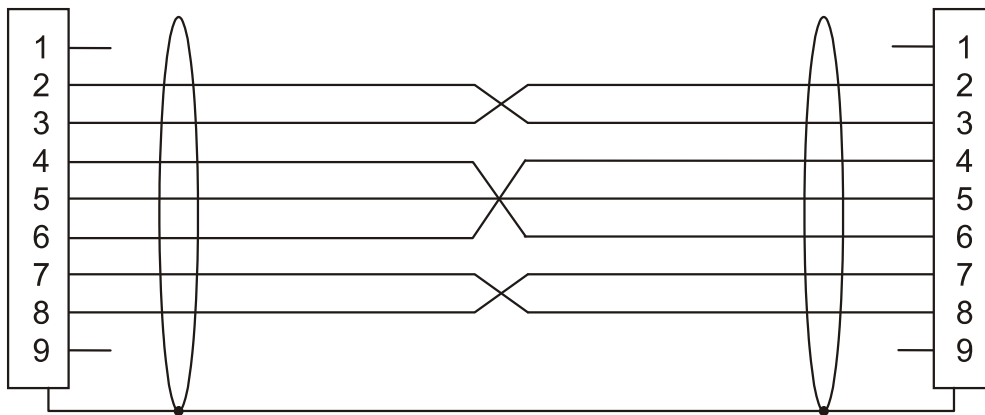

9.3 USB Connector

The mini-B type USB connector is laid out on the host interface side of the FP5.

Figure 9-6. USB Connector <FP5 Host Interface Side>

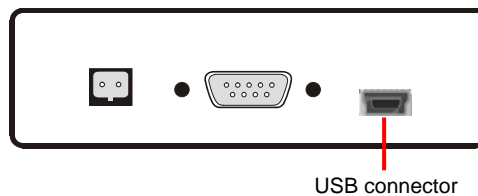

Part number of mini-B USB connector: UX60A-MB-5ST (made by Hirose Electric Co., Ltd.)

9.3.1 USB cable

The USB cable is approximately 2 meters long. The cable is equipped with a USB mini-B type connector and USB type A connector.

Figure 9-7. GND Cable External View



9.4 Target Connector

The target connector (15-pin HD-SUB female connector) is laid out on the target connector side of the FP5.

Figure 9-8. Target Connector <FP5 Target Connector Side>

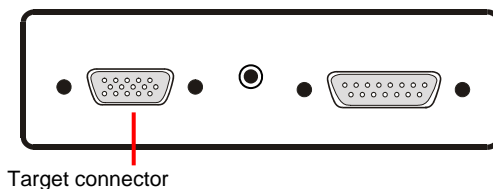

Figure 9-9. Target Connector (15-Pin HD-SUB Female Connector) Pin Assignment

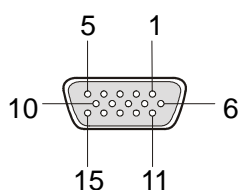

Table 9-2. Target Connector Pin Configuration

Target Connector	Signal Name
1	SO/TxD
2	SI/RxD
3	SCK
4	$\overline{\text{RESET}}$
5	V _{DD2}
6	FLMD1
7	H/S
8	V _{DD}
9	V _{DD}
10	RFU-1
11	V _{PP}
12	FLMD0
13	VDE
14	CLK
15	GND

Remark Part number of target connector (15-pin HD-SUB female connector): 070431FB015S200ZU (Suyin Connector Corp.)

<R> 9.4.1 Target Cable (16-pin type)

The target cable (16-pin type) is a standard shielded cable approximately 42 centimeters long. The target cable is equipped with a 15-pin HD-SUB male connector and a 16-pin 2.54 mm pitch multipurpose female connector.

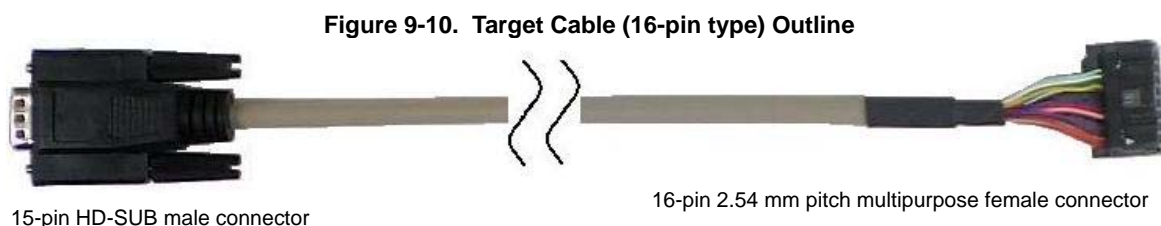

Figure 9-11. 15-Pin HD-SUB Male Connector Pin Assignment of Target Cable (16-pin type)

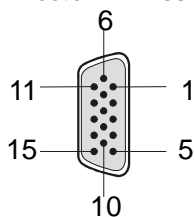

Figure 9-12. 16-Pin 2.54 mm Pitch Multipurpose Female Connector Outline of Target Cable (16-pin type) (View from Socket Side)

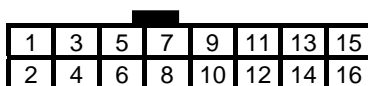

Table 9-3. Target Connector (16-pin type) Pin Configuration

Signal Name	15-Pin HD-SUB Male Connector	16-Pin 2.54 mm Pitch Multipurpose Female Connector
GND	15	1
RESET	4	2
SI/RxD	2	3
V _{DD} ^{Note 3}	8	4
SO/TxD	1	5
V _{PP}	11	6
SCK	3	7
H/S	7	8
CLK	14	9
VDE ^{Note 1}	13	10
V _{DD2}	5	11
FLMD1	6	12
RFU-1 ^{Note 1}	10	13
FLMD0	12	14
Not used ^{Note 2}	–	15
Not used ^{Note 2}	–	16

- Notes 1. Reserved pins. Leave these pins open.
- 2. Left open in the target cable (16-pin type).
- 3. No.9 pin of 15-pin HD-SUB connector is not connected to a 16-pin 2.54 mm pitch multipurpose connector.

Remark The following are the recommended connectors to be connected to 16-pin 2.54 mm pitch multipurpose female connectors.

- HIF3FC-16PA-2.54DS (made by Hirose Electric Co., Ltd., right angle type)
- HIF3FC-16PA-2.54DSA (made by Hirose Electric Co., Ltd., straight type)
- 7616-5002PL (Sumitomo 3M Limited, right angle type)
- 7616-6002PL (Sumitomo 3M Limited, straight type)

When using a self-made cable because the supplied cable cannot be used due to the target system specifications, the cable characteristics should be equivalent or higher than those of the supplied cable.

Note that communication may be performed at high speed depending on the communication settings. Consequently, communication errors may occur and causing abnormal operation.

<R> **9.4.2 Target cable (14-pin type)**

The target cable (14-pin type) is a standard shielded cable approximately 42 centimeters long. The target cable is equipped with a 15-pin HD-SUB male connector and a 14-pin 2.54 mm pitch multipurpose female connector.

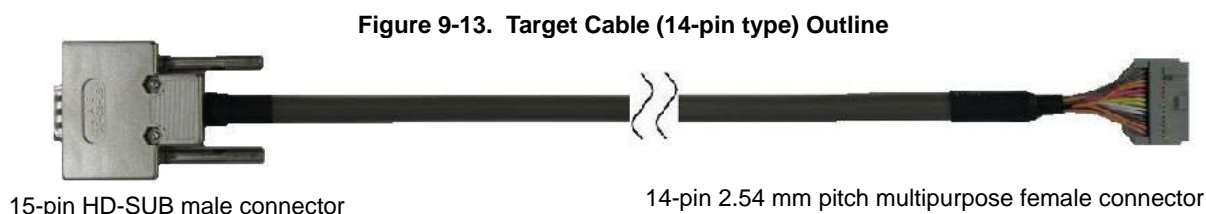
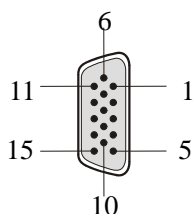

Figure 9-14. 15-Pin HD-SUB Male Connector Pin Assignment of Target Cable (14-pin type)



**Figure 9-15. 14-Pin 2.54 mm Pitch Multipurpose Female Connector Outline of Target Cable (14-pin type)
(View from Socket Side)**

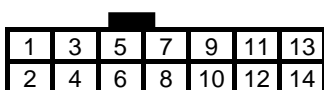

Table 9-3. Target Connector (14-pin type) Pin Configuration

FP5 Signal Name	15-Pin HD-SUB Male Connector	14-Pin 2.54 mm Pitch Multipurpose Female Connector
SCK/IO4	3	1
GND	15	2
CLK/IO5	14	3
FLMD0/IO0	12	4
SI/RxD	2	5
RFU-1 ^{Note 1} /IO1	10	6
SO/TxD/IO3	1	7
VDD	8	8
FLMD1	6	9
VDE/IO2	13	10
H/S	7	11
GND	15	12
RESET	4	13
Not used ^{Note 2}	–	14

- Notes**
1. Reserved pins. Leave these pins open.
 2. Left open in the target cable.

Remark The following are the recommended connectors to be connected to 14-pin 2.54 mm pitch multipurpose female connectors.

- 7614-6002 (Sumitomo 3M Limited, straight type)
- 2514-6002 (3M Limited, straight type)

When using a self-made cable because the target cable cannot be used due to the target system specifications, the cable characteristics should be equivalent or higher than those of the target cable.

Note that communication may be performed at high speed depending on the communication settings. Consequently, communication errors may occur and causing abnormal operation.

9.5 GND Connector

The banana jack GND connector is laid out on the target connector side of the FP5.

Figure 9-16. GND Connector <FP5 Target Connector Side>

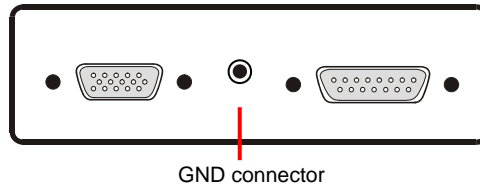

Remark Part number of GND connector (banana jack): PB4 (HIRSCHMANN)

9.5.1 GND cable

The host cable is a standard shielded GND cable approximately 1 meter long. The GND cable is equipped with a banana jack and a spade terminal.

Caution The FP5 and target system may be damaged if the voltage between the FP5 GND and the target system GND is different. Use the GND cable to match the voltage before connecting the target cable.

Figure 9-17. GND Cable Outline

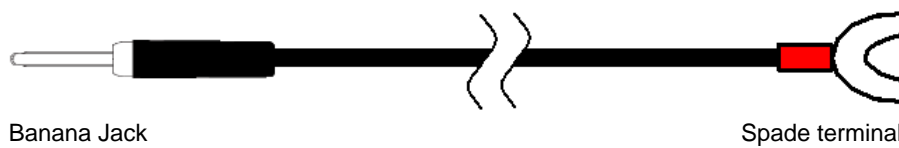

Remark Part number of banana jack: TJ-2167 (made by Sato Parts Co., Ltd.)
 Part number of spade terminal: BPF1.25-3 (red) (Daido Solderless Terminals Mfg. Co., Ltd.)

9.6 Remote Connector

The remote connector (a 15-pin D-SUB female connector) is laid out on the target connector side of the FP5.

Figure 9-18. GND Connector <FP5 Target Connector Side>

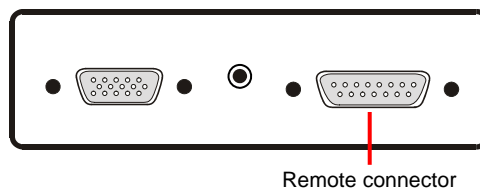
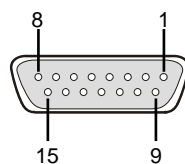

Figure 9-19. Remote connector (15-Pin D-SUB Female Connector) Pin Assignment



Remark Part number of remote connector (a 15-pin D-SUB female connector): 07433FB015S200ZU (Suyin Connector)

CHAPTER 10 NOTES ON TARGET SYSTEM DESIGN

This chapter explains the basic notes on the target system for writing to the flash memory in the target device, using the FP5.

(1/3)

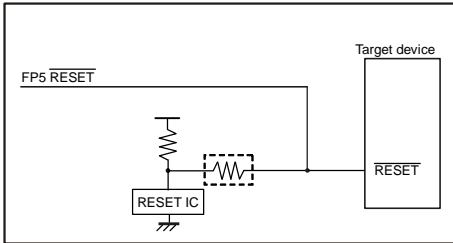
Target Device Pin	Recommended Design
Common item	<ul style="list-style-type: none"> When connecting the FP5 output signal pins, refer to CHAPTER 11 SPECIFICATIONS OF TARGET INTERFACE CIRCUITS and pull up (or pull down) with a resistance in compliance with the device specifications (V_{IH}, V_{IL}). When connecting the FP5 input signal pins, refer to CHAPTER 11 SPECIFICATIONS OF TARGET INTERFACE CIRCUITS and pull up (or pull down) with a resistance in compliance with the device specifications (I_{OH}, I_{OL}). After turning on the FP5 power supply, the states of the various terminals before and after command execution will be as follows: <ul style="list-style-type: none"> -The $\overline{R\overline{E}S\overline{E}T}$ pin will use Low output. (However, it will be Hi-Z if Hi-Z is set with the FP5 Manager.) -The pins other than the $\overline{R\overline{E}S\overline{E}T}$ pin and GND pin will be in the Hi-Z state. Observe the waveforms of the terminals on the target device. If the electrical specifications are not satisfactory, then shape the waveforms by adding buffers, and so on. If using a cable other than the included target cable, be sure to check the waveforms. Basically, the power supply and clock for the target device should be supplied from the target system. This, however, excludes some target devices which require supply from the FP5. When outputting the clock from the FP5, if the input specs of the target device are not satisfactory, then be sure to shape the waveform. Be sure to consider contact quality (such as conductivity, durability) of the connector connected to the target cable. We recommend a mechanism that connects to the GND pin. Unused pins of the target device are set to input mode. Leave them open
$\overline{R\overline{E}S\overline{E}T}$	<p>When the FP5 $\overline{R\overline{E}S\overline{E}T}$ pin is in the output mode (when the [Enable target RESET] of the [Command options] are not checked), do not connect the $\overline{R\overline{E}S\overline{E}T}$ signal generating circuit of the target system to the FP5 $\overline{R\overline{E}S\overline{E}T}$ signal, or signal collision would occur.</p> <p>Do not connect the $\overline{R\overline{E}S\overline{E}T}$ signal generator on the target system to the $\overline{R\overline{E}S\overline{E}T}$ signal of the FP5. Otherwise, a signal conflict will occur. To avoid a conflict, isolate the $\overline{R\overline{E}S\overline{E}T}$ signal generator from the $\overline{R\overline{E}S\overline{E}T}$ signal of the FP5. Do not generate $\overline{R\overline{E}S\overline{E}T}$ while the FP5 is connected. This must be especially noted in a target system in which an external watchdog timer is used.</p> <p>Connect the $\overline{R\overline{E}S\overline{E}T}$ signal of the FP5 at a point where the status of the FP5 $\overline{R\overline{E}S\overline{E}T}$ signal and that of the CPU $\overline{R\overline{E}S\overline{E}T}$ pin are the same.</p> <p>Correct connection <1>:</p>  <p>RESET IC is an open-drain type circuit. Connect a resistor to the portion above enclosed in the dotted line, as necessary.</p>

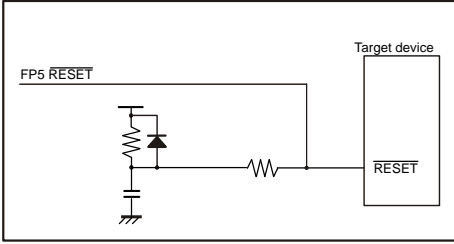
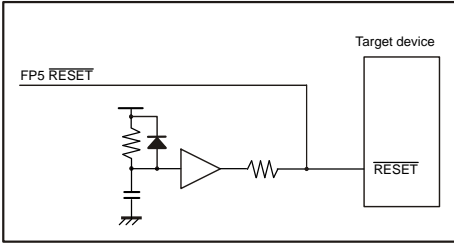
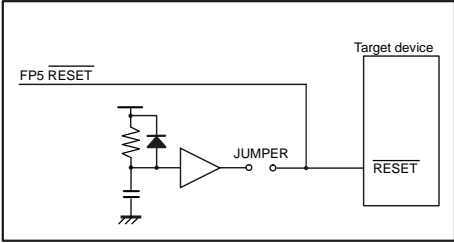
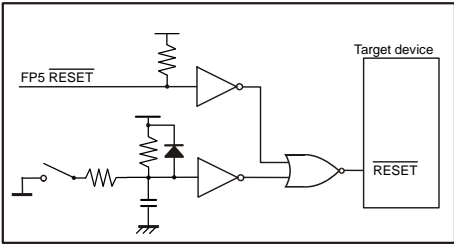
Target Device Pin	Recommended Design
<p>RESET</p>	<p>Correct connection <2>:</p>  <p>Correct connection <3>:</p>  <p>Correct connection <4>:</p>  <p>Correct connection <5>:</p> 

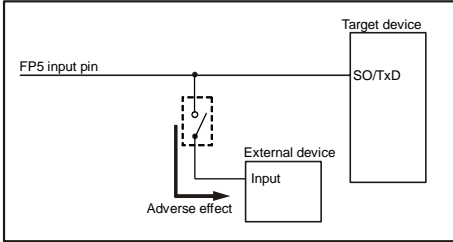
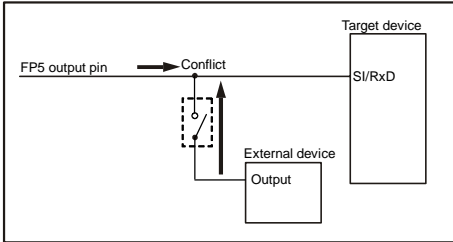
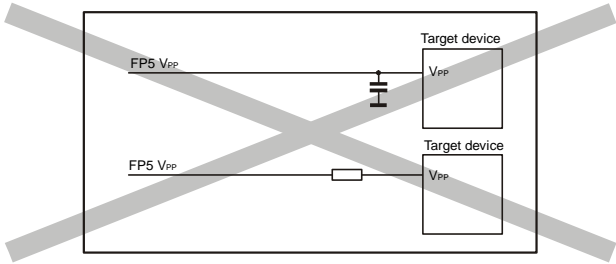
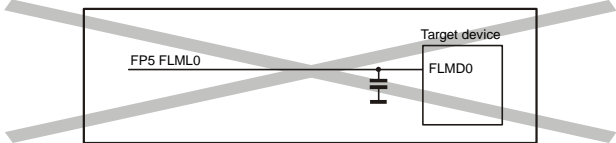
Target Device Pin	Recommended Design
<p>I/O pins</p>	<p>When a target device pin used by the FP5 is also connected to the input of an external device, and if that target device malfunctions, disconnect the external device as shown in the portion below enclosed in the dotted line or make it output high impedance like dotted line.</p> <p>Example:</p>  <p>If a target device pin used by the FP5 is also connected to the output of an external device like dotted line, and a signal collision occurs, disconnect the external device as shown in the portion below enclosed in the dotted line.</p> <p>Example:</p> 
<p>V_{PP}</p>	<p>Keep the wiring between the FP5 connector and the target device V_{PP} pin as thick and as short as possible.</p> <p>Insert neither capacitors nor resistors into the V_{PP} line unless otherwise stated.</p> <p>Incorrect circuit:</p> 
<p>FLMD0</p>	<p>Insert neither capacitors nor resistors into the FLMD0 line unless otherwise stated.</p> 
<p>FLMD1</p>	<p>Connect the FP5, or GND using pull-down resistance on board.</p>
<p>Others</p>	<p>For the recommended connection of unused pins, refer to the user's manual of the target device.</p> <p>Some target devices have pins that must be connected differently. For these pins also, refer to the user's manual of the target device.</p> <p>Example of pins connected differently: MODE, CKSEL, REGOUT, REGIN, etc.</p>

The following are examples of interface circuits. Refer to the recommended design for the connection of pins in the target device.

<1> SIO-H/S (3-wire clocked communication port, with handshake)

Figure 10-1. SIO-H/S Interface Circuit Example

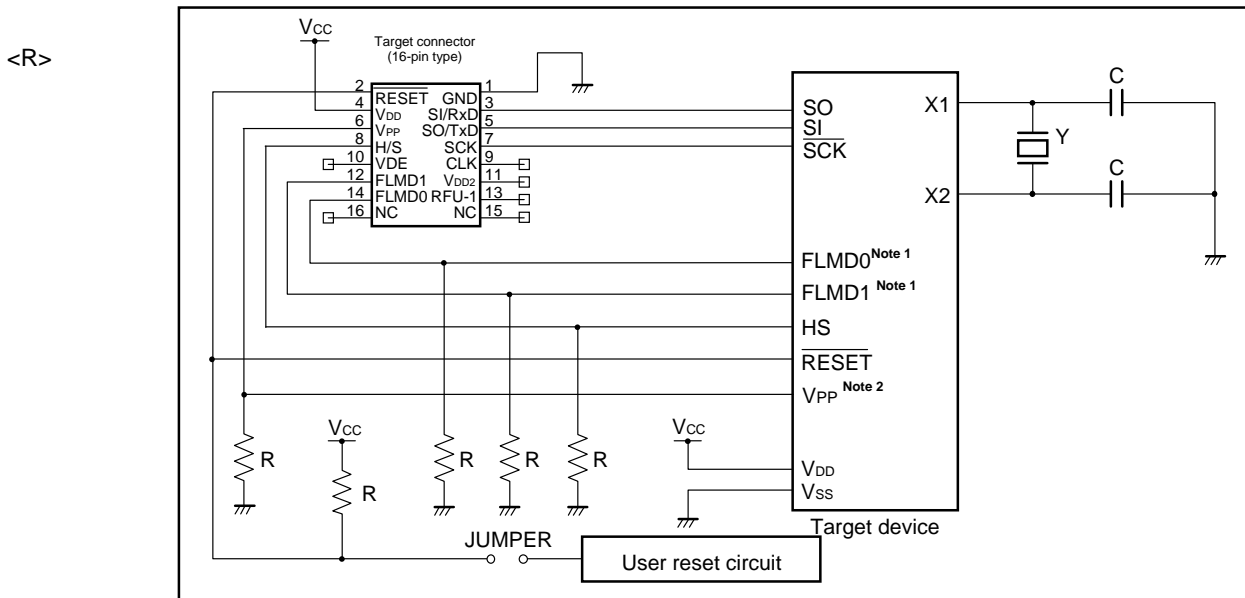

- Notes 1. Pin used in internal single-power-supply flash memory microcontroller
- 2. Pin used in internal two-power-supply flash memory microcontroller

<2> 78K0S (Single-wire UART)

Figure 10-2. Circuit Example for 78K0S (Single-wire UART)

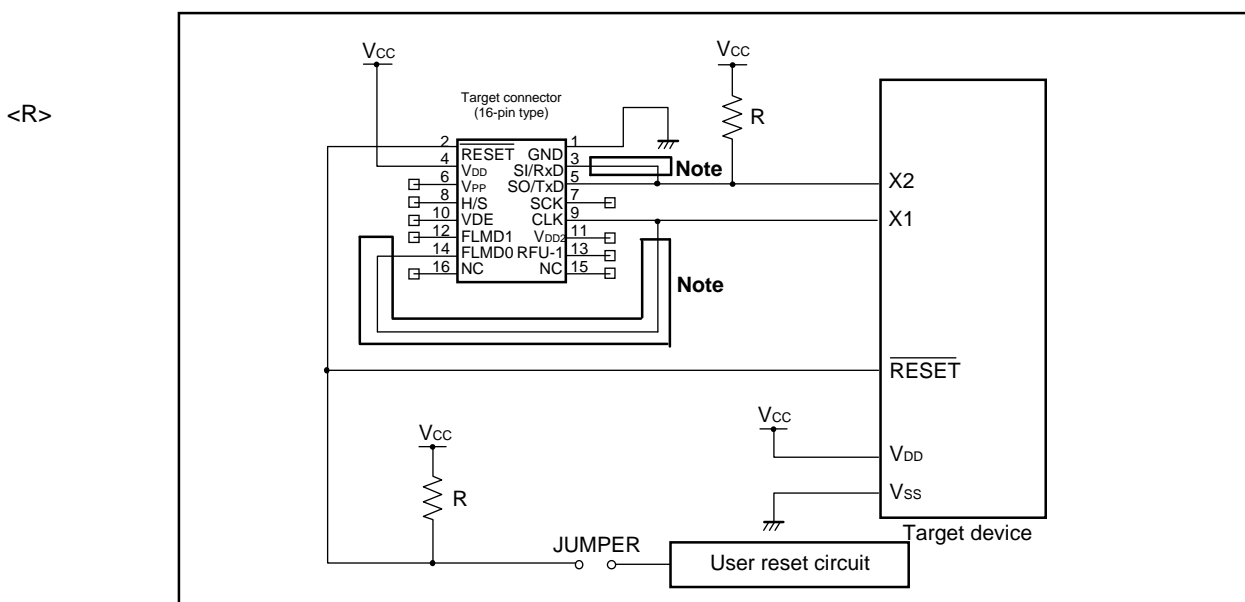

Note These pins do not need to be shorted when using the FP5. Short them if necessary.

<3> 78K0R (Single-wire UART)

Figure 10-3. Circuit Example for 78K0R (Single-wire UART)

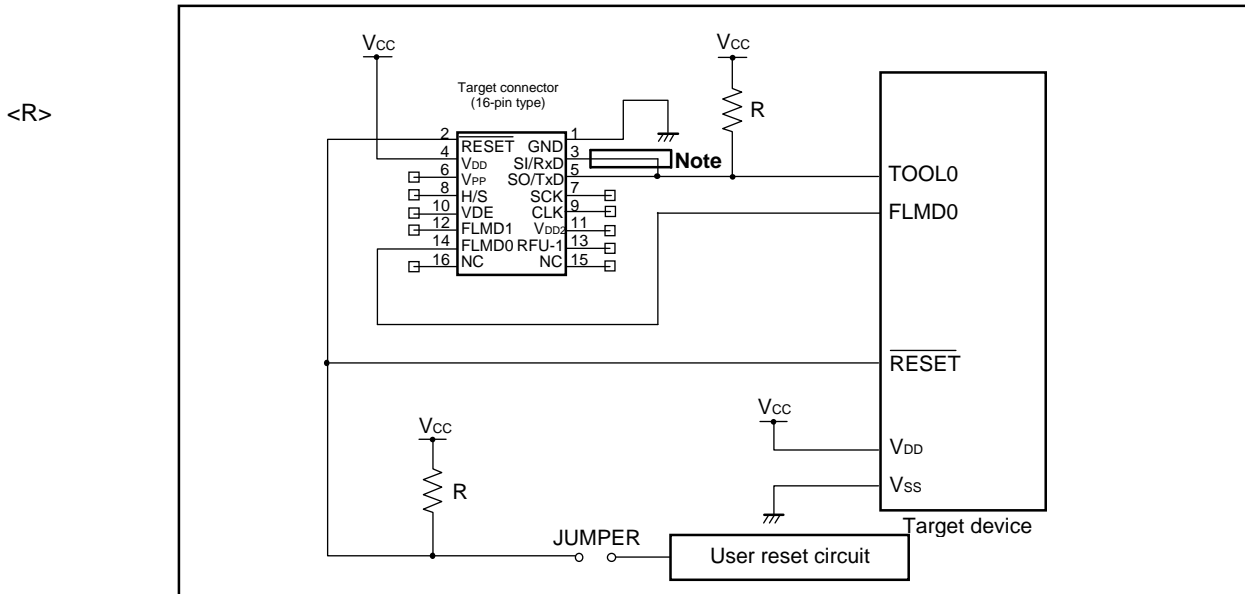

Note These pins do not need to be shorted when using the FP5. Short them if necessary.

<4> I²C

Figure 10-4. Circuit Example for I²C

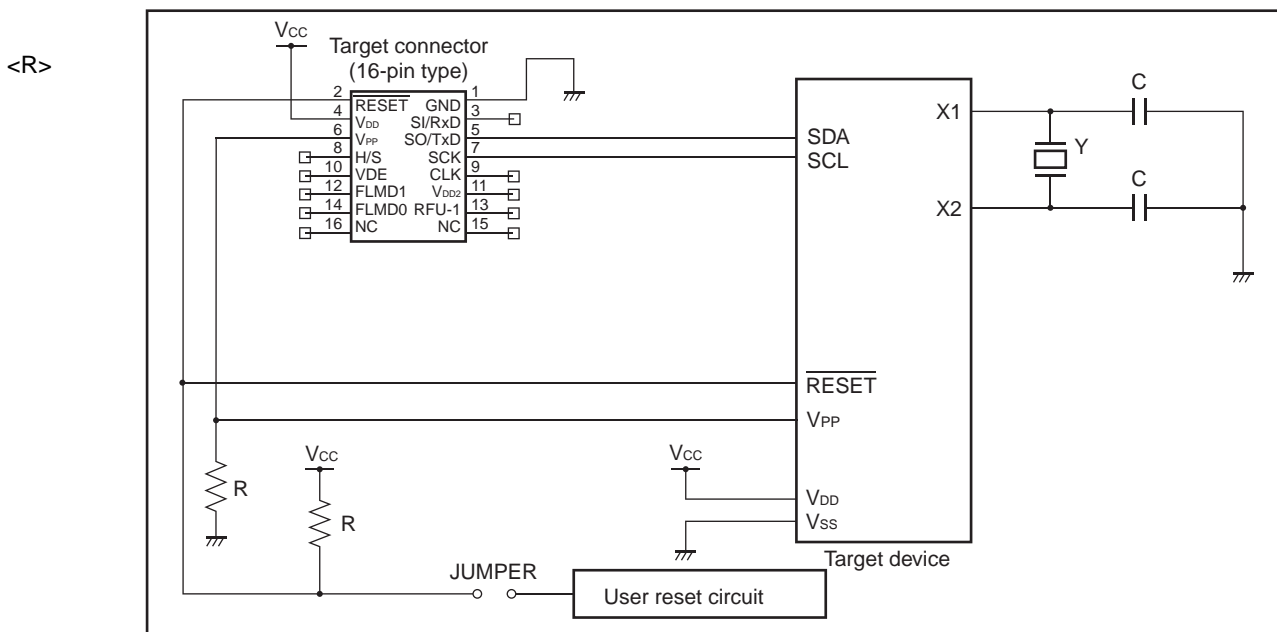

<5> 78K0 (TOOLCx, TOOLDx)

Figure 10-5. Circuit Example for 78K0 (TOOLCx, TOOLDx)

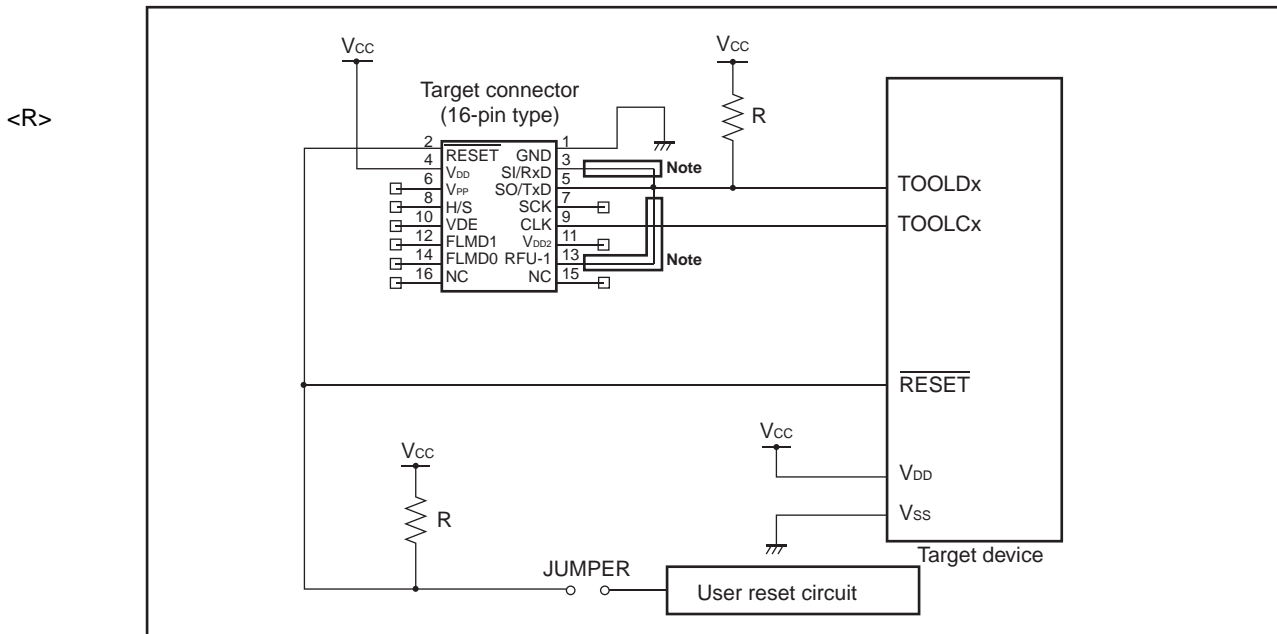

Note These pins do not need to be shorted when using the FP5. Short them if necessary.

<R> <6> V850E2 (Single-wire UART)

Figure 10-6. Circuit Example for V850E2 (Single-wire UART)

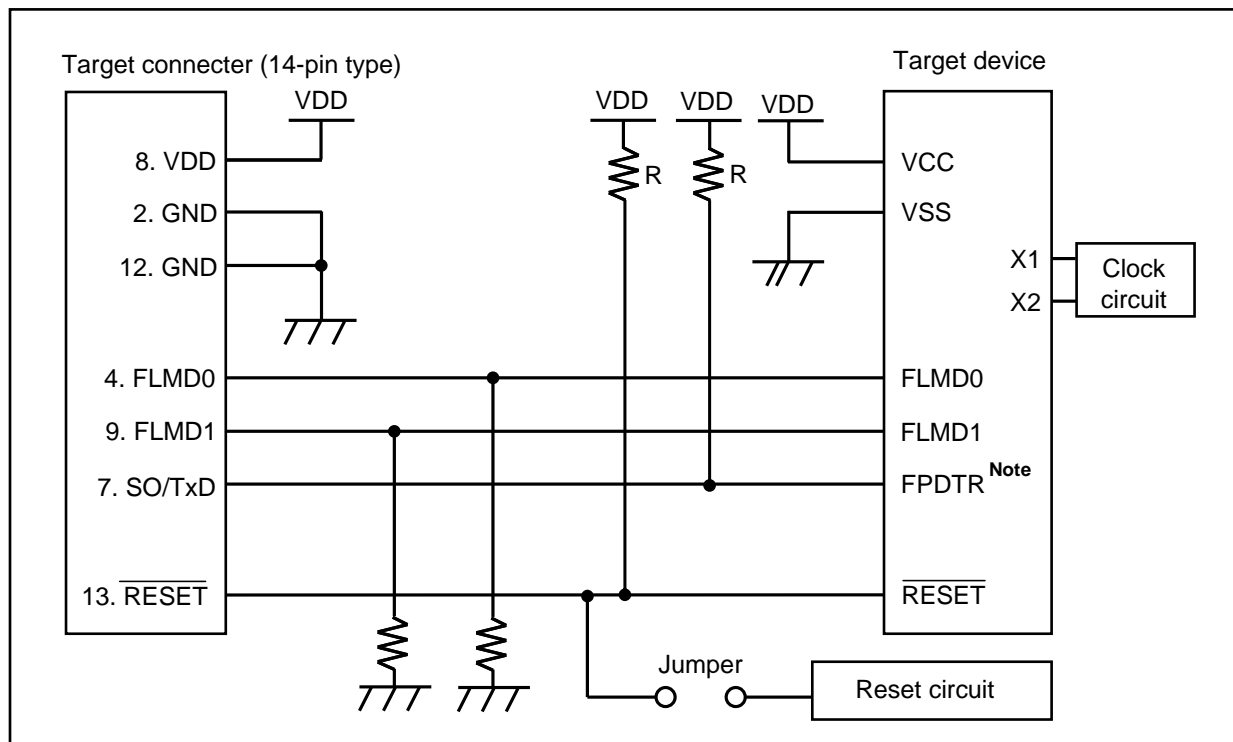

Note The pin names might differ depending on the target device. For details about the actual pin names, see the user's manual of each target device.

<R> <7> V850E2 (CSI)

Figure 10-7. Circuit Example for V850E2 (CSI)

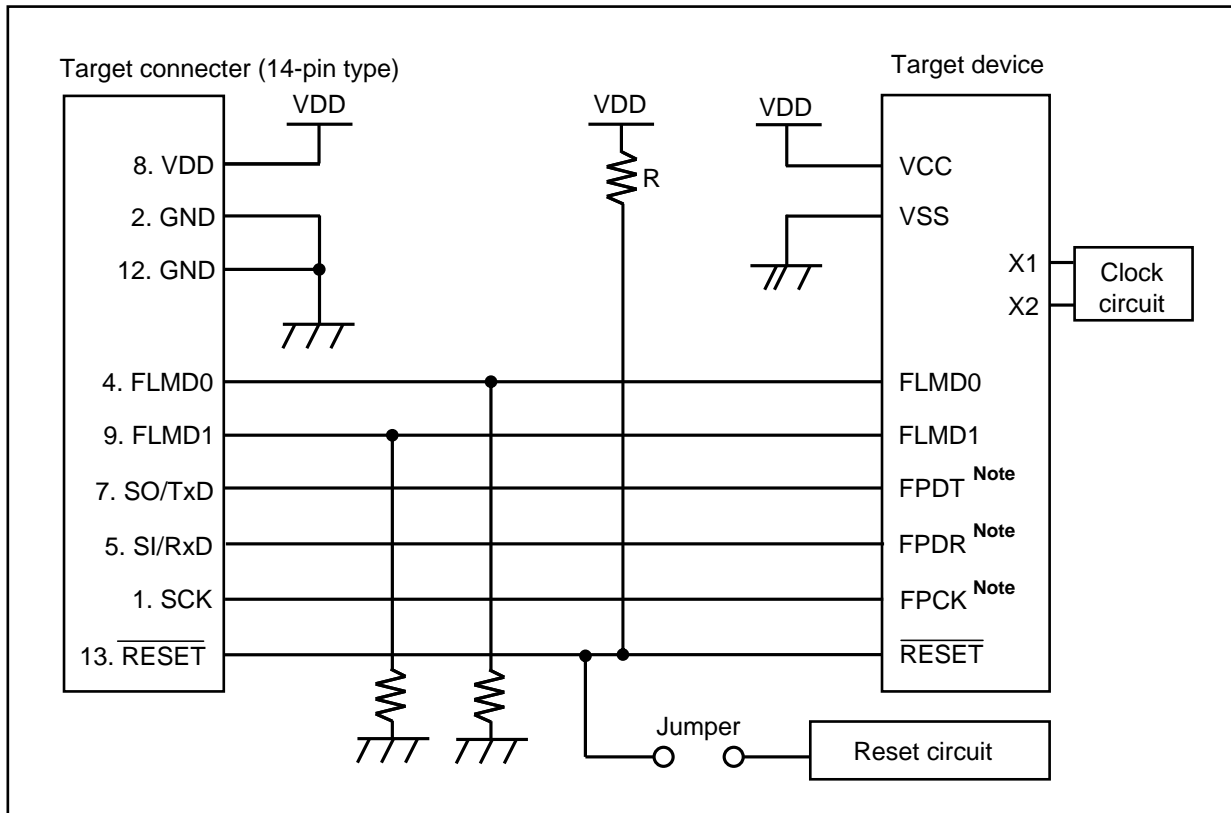

Note The pin names might differ depending on the target device. For details about the actual pin names, see the user's manual of each target device.

<R> <8> RL78 family (VDD = EVDD)

Figure 10-8. Circuit Example for RL78 Family (VDD = EVDD)

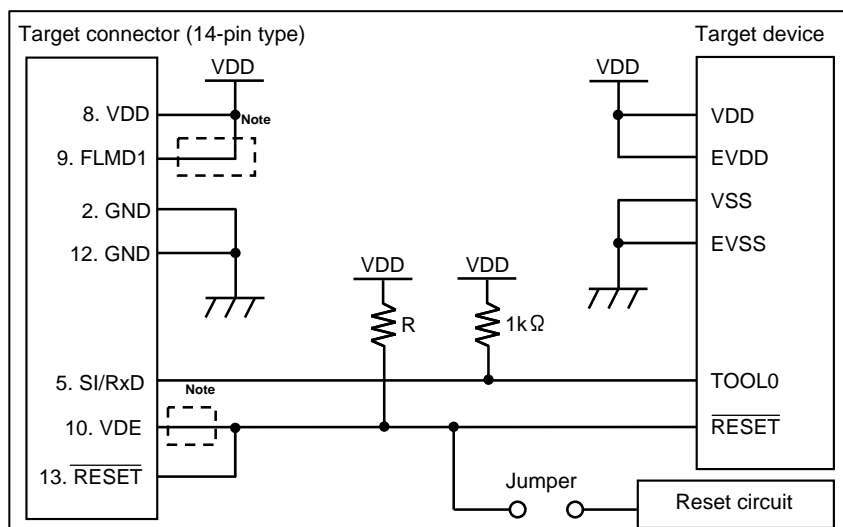

Note It must be connected when the E1/E20 emulator is used. However, it doesn't have to be connected when the PG-FP5 is used.

<R> <9> RL78 family (VDD ≠ EVDD)

Figure 10-9. Circuit Example for RL78 Family (VDD ≠ EVDD)

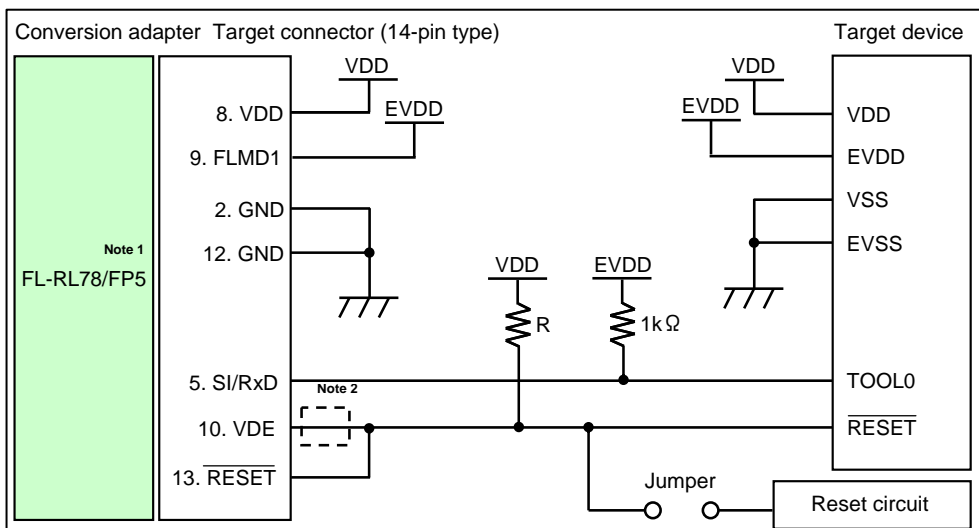

Notes 1. To perform write when VDD ≠ EVDD, connect the conversion adapter FL-RL78/FP5 (a product of Naito Densai Machida Mfg. Co., Ltd.). On the [Advanced] tab in the Device Setup dialog box, enter the voltage value of VDD in the [Vdd[V]] box, enter 0V in the [Vdd2[V]] box, and select the [On Target] check box. For the system configuration and specifications of the FL-RL78/FP5, refer to the FL-RL78/FP5 User's Manual.

2. It must be connected when the E1/E20 emulator is used. However, it doesn't have to be connected when the PG-FP5 is used.

<R> <10> RX family, SuperH family

Figure 10-10. Circuit Example for RX Family and SuperH Family

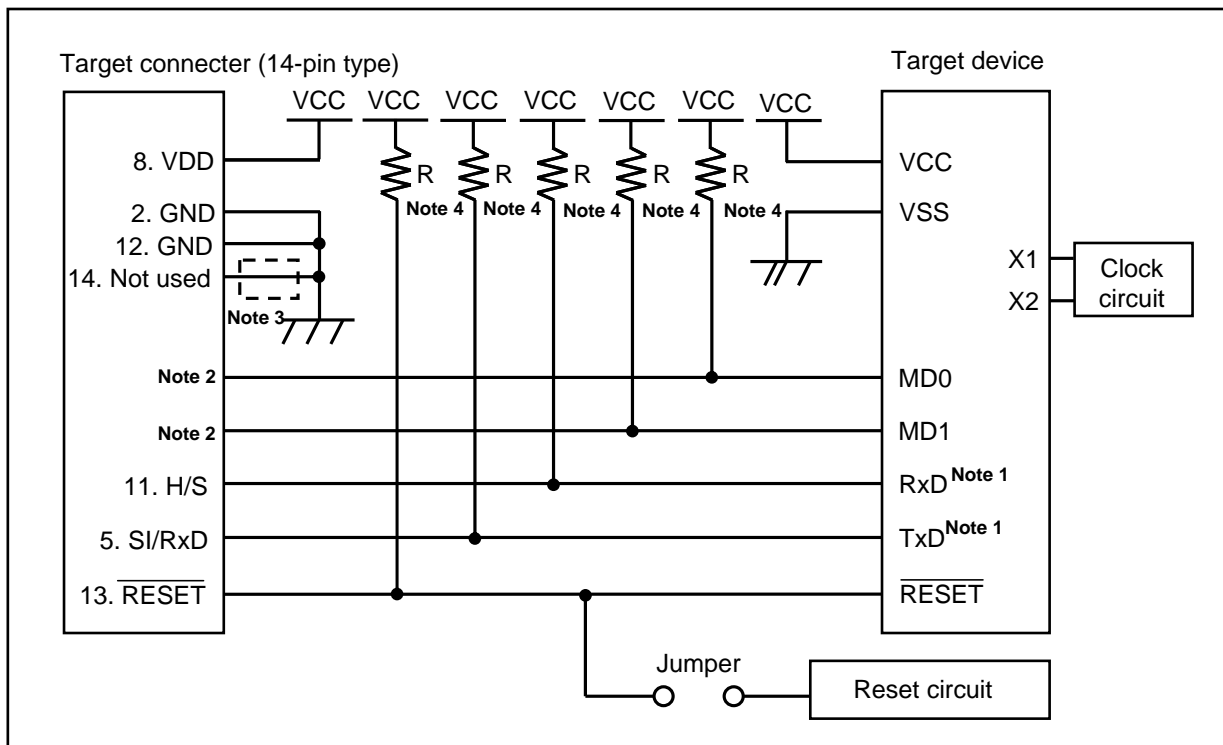

- Notes**
1. For the serial communication interface (SCI) that can be used for writing, refer to the user's manual of the target device.
 2. Connect the MD0 and MD1 pins to any of the IO0 to IO5 pins. The signal settings for IO0 to IO5 pins can be set in the [I/O Signal Settings] area on the [Advanced] tab in the Device Setup dialog box. Set MD0 to High, MD1 to Low, and unused I/O signals to High-Z. Normally, use the initial settings in the [I/O Signal Settings] area. It is compatible with write circuit examples with Flash Development Toolkit.
 3. These pins do not need to be shorted when using FP5. Short them when using E1, E20 or E8a together.
 4. Set the R value to between 4.7 and 10 kΩ when using E1, E20 or E8a together.

<R> <11> R8C family

Figure 10-11. Circuit Example for R8C Family

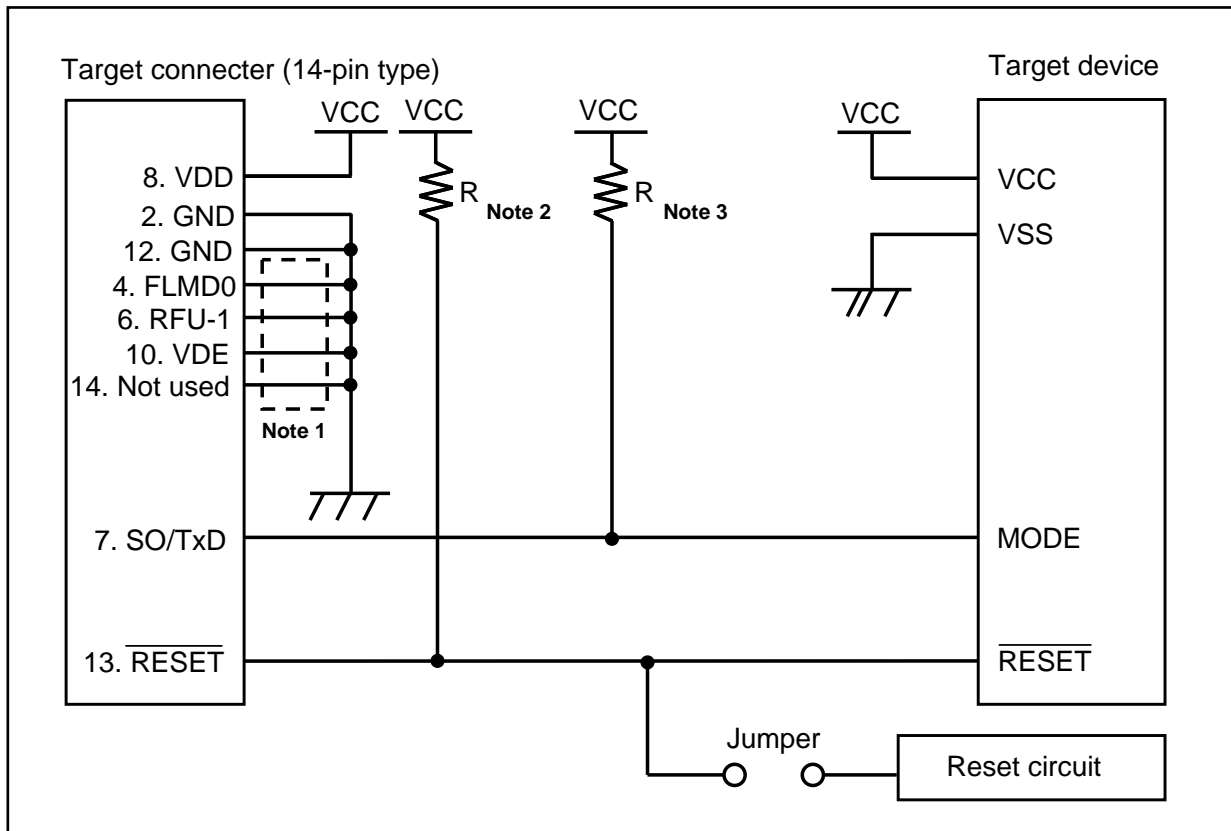

- Notes**
1. These pins do not need to be shorted when using FP5. Short them when using E1, E20 or E8a together.
 2. Set the R value to 4.7 kΩ or higher when using E1, E20 or E8a together.
 3. Set the R value to 4.7 kΩ ± 10% when using E1, E20 or E8a together.

CHAPTER 11 SPECIFICATIONS OF TARGET INTERFACE CIRCUITS

This chapter describes the target interface specifications (signals connected to the FP5 and the target system), by using equivalent circuits.

11.1 SO/TxD, RESE and SCK

When V_{DD}/V_{DD2} are supplied from the target system for target device programming, the FP5 internal voltage regulator is protected so that user V_{DD}/V_{DD2} will not affect the SO/TxD, RESE and SCK signal lines.

In either case, these signal lines output C-MOS level signals. When a 78K0R, 78K0S/Kx1+ microcontrollers or the μPD78F9334 is used, the SO/TxD signal line functions as an open-drain output.

Figure 11-1. SO/TxD, RESE and SCK Pins

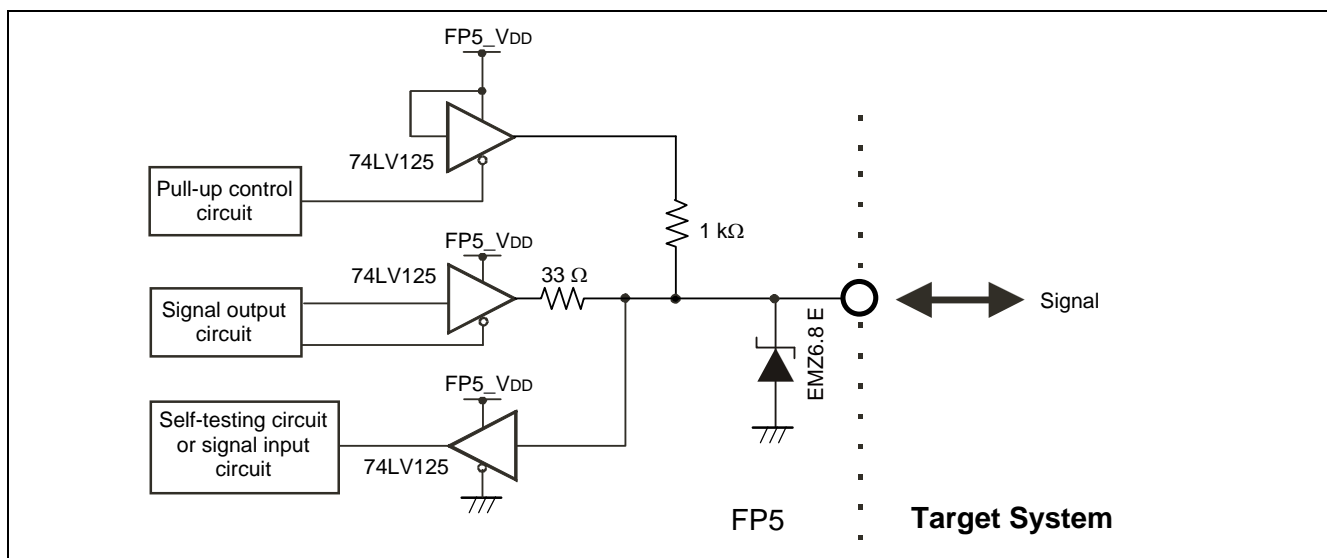

11.2 SI/RxD and H/S

<R> The SI/RxD and H/S input signal voltages must not exceed the rated maximum voltage. However, for the RL78, the SI/RxD pin becomes an I/O pin, and it is open-drain output upon output. For the RX family and SuperH family, the H/S signal line is C-MOS level output.

Figure 11-2. SI/RxD and H/S Pins

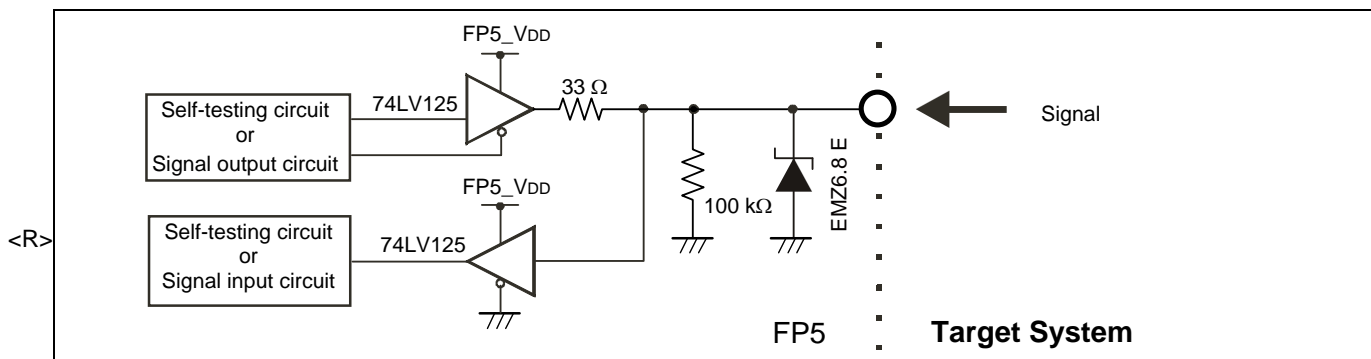

11.3 CLK

It is recommended to supply the target device operating clock from the target system. When supplying the target device operating clock from the FP5, communication may not be performed normally due to the waveform distortion caused by wiring of clock lines on the target system. In such a case, add elements such as CMOS buffers to the target system as necessary so as to adjust the waveform.

Figure 11-3. CLK Pins

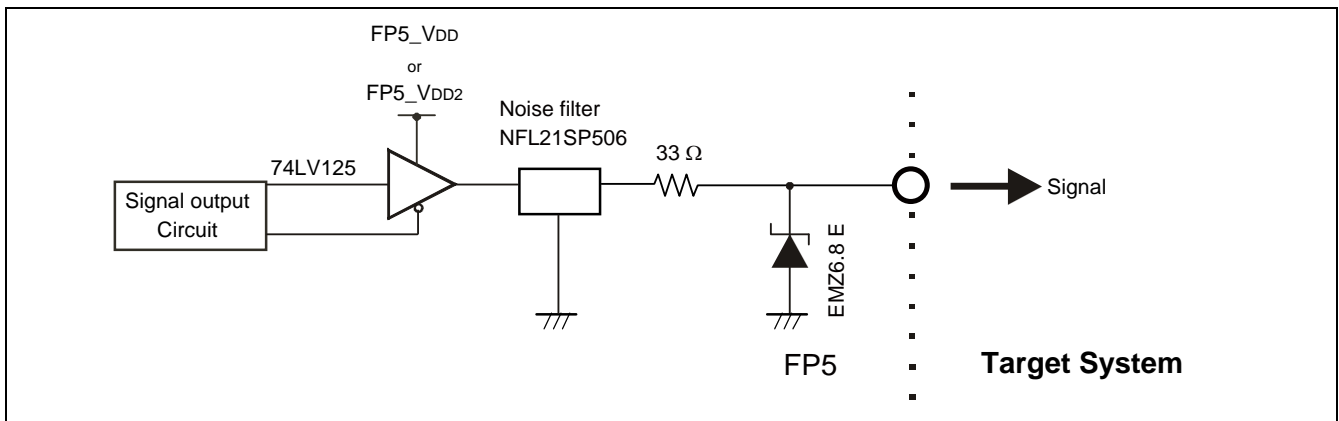

11.4 FLMD0 and FLMD1

Figure 11-4. FLMD0 and FLMD1 Pins

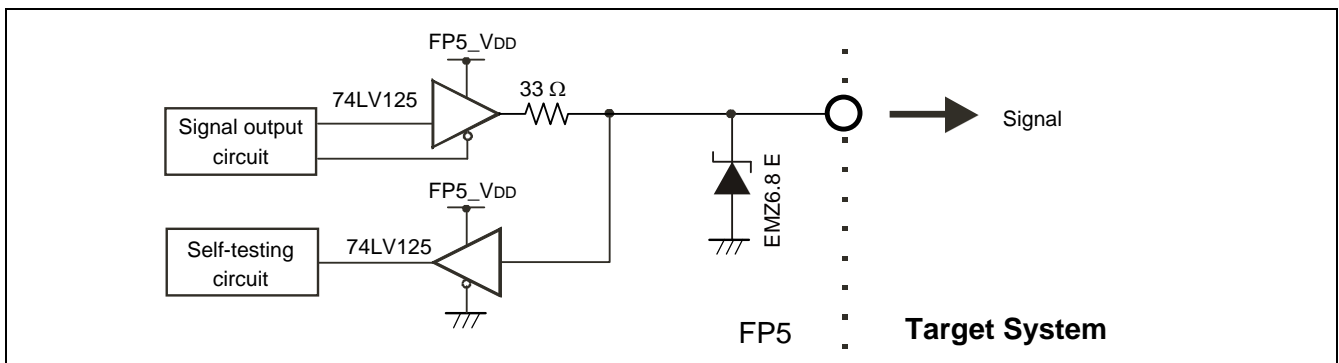

11.5 V_{DD} and V_{DD2}

When supplying V_{DD} and V_{DD2} from the target system, the FP5 internal power supply and the external voltage regulator is protected by a transistor.

Figure 11-5. V_{DD} and V_{DD2} Pins

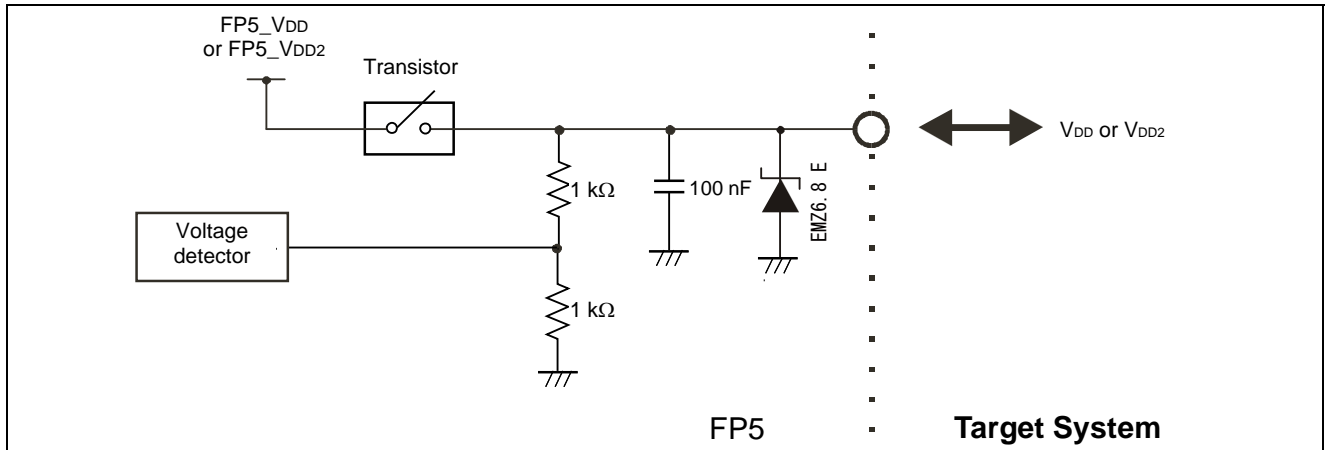

11.6 V_{PP}

Figure 11-6. V_{PP} Pin

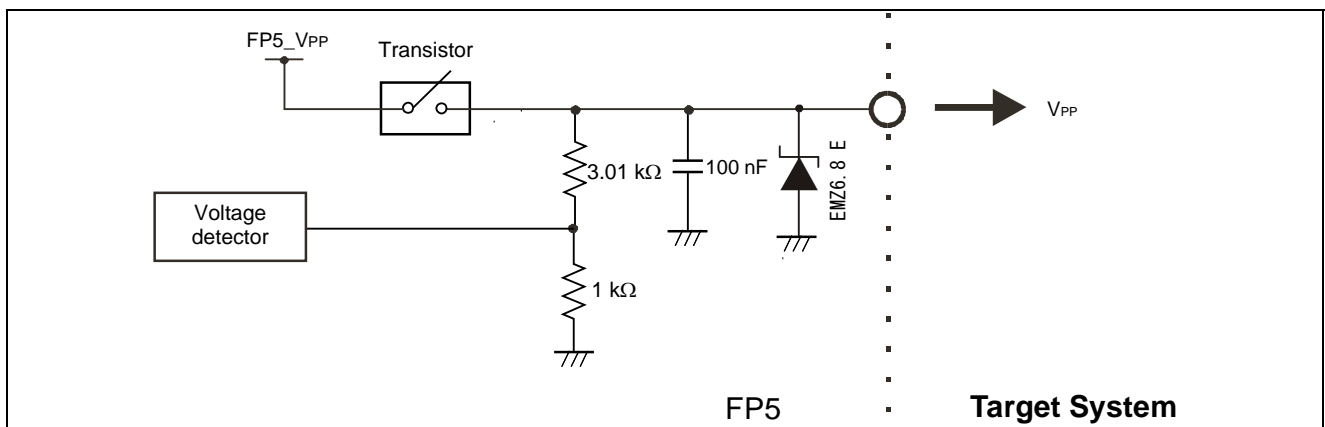

CHAPTER 12 TROUBLESHOOTING

This chapter explains troubleshooting.

Remark Using the self-testing function, the user can find out the reason why the FP5 does not operate normally, such as a defect in the FP5, or problems in other hardware. For how to use the tool, refer to **4.3.2 (6) [Self-Test] command**.

12.1 Problems During Startup

This section explains troubleshooting for problems that may occur between software installation and startup.

(1) The **POWER button on FP5 is pressed but the LED does not turn on.**

[Cause]

The cause may be a poor connection of the FP5 or AC adapter, or a possible defect.

[Action]

Confirm that the AC adapter is plugged in firmly. If this does not resolve the problem, consider repair.

(2) When the USB cable is connected and power to the FP5 is turned on, the driver is not recognized by Plug and Play.

[Cause]

The USB connector may not be inserted properly into the USB port.

[Action]

Confirm that the USB connectors are fully inserted into the USB ports of the host machine and the FP5. Alternatively, disconnect the USB connector and insert it again after a short time.

(3) The USB driver file cannot be found at a specified location.

[Cause]

<R> The USB driver may not have been installed correctly.

[Action]

<R> Refer to **CHAPTER 3 SOFTWARE INSTALLATION** and reinstall the USB driver.

(4) The “Add New Hardware Wizard” screen appears when FP5 is connected with the host machine via a USB port.

[Cause]

If the USB connector is not inserted into the USB port used during USB driver installation but into another USB port, the FP5 may be recognized as a new hardware item.

[Action]

Refer to **CHAPTER 3 SOFTWARE INSTALLATION** and install the USB driver again.

12.2 Problems During Operation

This section explains troubleshooting for problems that may occur during operation.

Remark For causes and actions for the messages displayed in the error dialog box, information dialog box or action log window, refer to **APPENDIX A MESSAGES**.

(1) Error Message “E 1100 communication within host PC and Flash Programmer is broken” is displayed in the action log window.

[Cause 1]

The USB cable or serial cable may not be connected properly, the USB driver may not have been installed correctly, or power to the FP5 has been turned off.

[Action 1]

Refer to **12.1 Problems During Startup** and take appropriate action.

[Cause 2]

<R> When “Renesas USB Development Tools” is expanded in the Device Manager while the FP5 is connected via a USB port, “Flash Programmer FP5” is not displayed. Alternatively, a “!” or “x” is attached.

[Action 2]

<1> Turn on power to the FP5 while it is connected to the host machine via a USB port, right-click the driver marked with the “!” or “x”, and then click [Delete (E)] on the shortcut menu.

<2> Execute [Scan for hardware changes] in the Device Manager.

<R> <3> Reinstall the USB driver with Plug and Play.

[Cause 3]

The FP5 may not have been recognized (when connected via USB hub).

[Action 3]

Try the following.

<1> Disconnect the USB cable and then reconnect it.

<2> Connect the USB connector to another port on the USB hub.

<3> If the above measures do not resolve the problem, do not use the USB hub but directly connect the USB connector to the USB port of the host machine.

(2) The following messages are displayed in the action log window and the flash memory programming mode cannot be entered.

ERROR(E012):Connection or synchronization failed

ERROR(E014):Connection or synchronization failed

[Cause 1]

The connection between the target system and FP5 may be incorrect.

[Action 1]

<R> <1> For the 78K or V850, connect the SO/TxD and SI/RxD signals from the FP5 with TxD (SO) and RxD (SI) of the target device so that signal input/output are consistent.

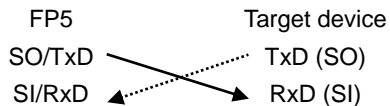

<2> The target interface must be isolated from other devices, using jumper switches or the like; otherwise, malfunction may occur. Refer to **CHAPTER 10 NOTES ON TARGET SYSTEM DESIGN, CHAPTER 11 SPECIFICATIONS OF TARGET INTERFACE CIRCUITS** or the user's manual of the target device. Moreover, monitor the actual waveform to confirm that the signal is not distorted and the signal level is correct.

[Cause 2]

Connection of pins for other than for the target interface may be incorrect.

[Action 2]

Refer to **CHAPTER 10 NOTES ON TARGET SYSTEM DESIGN** or the user's manual of the target device.

[Cause 3]

The PR5 file selected in the [Parameter and Setting file] area on the [Target] tab in the Device Setup dialog box may not be correct.

[Action 3]

Use the PR5 file that supports the target device.

For details on PR5 files, refer to **1.3 Supported Devices** and **4.3.3 (15) (a) [Parameter and Setting file] area**.

[Cause 4]

The clock may not be able to be supplied to the target device.

[Action 4]

<1> Check the settings in the [Supply oscillator] area on the [Standard] tab in the Device Setup dialog box. For the correct settings, refer to the supplementary materials for the PR5 file or the user's manual of the target device.

<2> Check the clock supply on the target system by means such as waveform monitoring.

[Cause 5]

Power may not be supplied correctly to the target device.

[Action 5]

<1> Check the settings in the [Supply voltage] area on the [Advanced] tab in the Device Setup dialog box.

<2> Check that power is supplied from the target system. If power is supplied from the FP5, a power shortage may occur because its maximum power supply is 200 mA. In such a case, supply power from the target system and then change the setting.

[Cause 6]

UART communication may not be synchronized.

[Action 6]

When UART is used, communication may not be synchronized due to a baud rate error of the target device. In this case, change the CPU clock or baud rate, or change the communication channel to another communication mode.

[Cause 7]

If using a 78K0S/Kx1+ microcontroller or the UPD78F9334, it is possible that the wrong connection procedure was implemented.

[Action 7]

With devices that using program files in which “use the RESET pin as the input-only port (P34)” is set by the option byte, flash memory programming mode cannot be entered if power is supplied to the target system before the target cable is connected to the target system. Connect the target cable to the target system and then supply power to the target system as prescribed in the connection procedure.

<R> [Cause 8]

For the RX family and Super H family, the I/O signal setting does not match the wiring of the target system.

<R> [Action 8]

Check if the settings in the [I/O Signal Settings] area on the [Advanced] tab in the Device Setup dialog box match the wiring of the target system.

(3) The following message is displayed in the action log window and normal communication is not performed in flash memory programming mode.

ERROR Communication failure or timeout.

[Cause 1]

The clock or power supply may not be stable.

[Action 1]

Confirm that the clock or power is supplied on the target system.

[Cause 2]

Communication may not be stable.

[Action 2]

<1> Confirm that no noise is applied to communication.

<2> Confirm that the FP5 and target system are properly connected.

<3> Confirm that unused pins are properly handled.

<4> Confirm that an appropriate clock and communication rate are selected. Stable programming may be achieved by setting a lower value for the clock or communication rate.

APPENDIX A MESSAGES

A.1 Message Format

Messages will be output in the error/warning dialog boxes, information dialog boxes, or action log window during programming GUI operation. Error messages will be displayed on the FP5 message display during standalone operation.

Figure A-1. Error/Warning Dialog Box

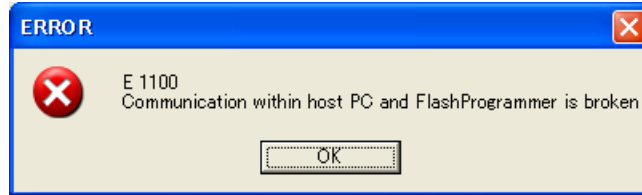

Figure A-2. Information Dialog Box

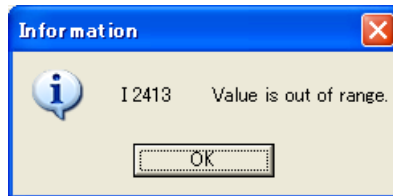

Figure A-3. Action Log Window

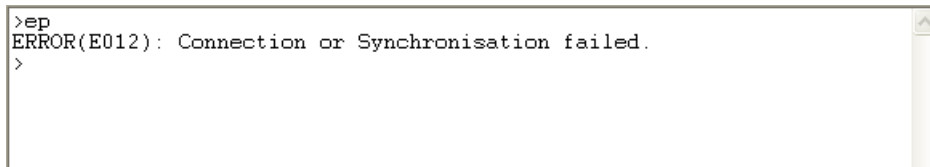
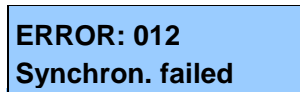

Figure A-4. Error Message FP5 Message Display



A.2 Error/Warning Dialog Boxes for Programming GUI Operation

(1/3)

No.	Message	Description
E 1100	Communication within host PC and FlashProgrammer is broken	An error occurred in communication between the host machine and the FP5. Check the cable connection and FP5 power supply.
E 1101	Can't setup communication within host PC and FlashProgrammer	Communication between the host machine and FP5 cannot be established. Check the cable connection and power supply. Moreover, check if the USB driver is installed correctly.
E 1102	Can't find parameter file	The specified PR5 file could not be found.
E 1103	Open parameter file failed	The specified PR5 file cannot be opened.
E 1105	Unable to open last active PRM/SET file. Using most recent settings.	The PR5/ESF file in the valid programming area cannot be opened. The latest setting will be used.
E 1106	Firmware is not valid or version is lower than requirement.	Incorrect version information or an old version was detected. Update the FP5 firmware.
E 1107	Parameter area format is not match with initial file. Do you want reset parameter area format?	The factor for dividing the programming area does not match the one defined in the INI file. Select whether to reset the division factor. If reset, it is divided into four areas and the contents are deleted.
E 1108	No invalid Parameter file defined. GUI can not work properly.	The GUI will not operate normally because no valid PR5 file has been defined. Set it in the Device Setup dialog box.
E 1109	No parameter file exists in this project folder. Please select parameter files.	There is no parameter file in user selected folder. GUI waited user to find out one or more parameter files in other folder.
E 1201	Invalid file.	The specified file cannot be opened. Set it in the Device Setup dialog box.
E 1202	<Setting file name> is not valid. Using most recent settings.	An incorrect format or value was detected in the ESF file. The ESF file defined in the INI file will be used instead. Set it in the Device Setup dialog box.
E 1203	<Parameter file name> is not valid. Using most recent settings.	An incorrect format or value was detected in the PR5 file. The ESF file defined in the INI file will be used instead. Set it in the Device Setup dialog box.
E 1204	Download of parameter file failed.	Downloading of the PR5 file has failed. The PR5 file may be invalid. Re-set the connection between the host machine and FP5.
E 1205	Download of setting file failed.	Downloading of the ESF file has failed. The ESF file may be invalid. Re-set the connection between the host machine and FP5.
E 1206	File name is not valid.	The specified file cannot be opened for writing. Make sure that the file attribute is not set to read-only.
E 1400	Password is invalid. Effective password consists one to eight any alphanumeric character. It is case insensitive.	Password contains invalid character or out of size range.
E 1401	The password does not match. [Yes]: Retry to input the password [No]: Initialize the password and format to the shipment condition.	Password is different with defined content.

(2/3)

No.	Message	Description
E 1501	This file is not valid.	The file opened with the HEX Editor is invalid.
E 1502	Caution: Data Flash access unit is DWORD.	The data flash area can be accessed in double-word units, but an access was attempted in unsupported units.
E 1503	Caution: Out of range!	The address range for saving data is out of the code flash or data flash address range. Check the start/end address.
E 1504	Caution: Start address should not larger than End address.	The start address is larger than the end address. Check the start/end address.
E 1505	Caution: End address should not smaller than start address.	The end address is smaller than the start address. Check the start/end address.
E 1506	The file cannot be read.	The file opened with the HEX Editor is invalid.
E 1507	No HEX data.	The program file format may be incorrect.
E 1508	The file cannot be written.	Saving of the program file has failed. Check if this file is occupied by another program.
E 1509	Temporary file could not be created.Abort	The temporary file cannot be created. Creation was aborted. Confirm that sufficient memory capacity is available in Windows.
E 1510	Can not open <file name> Abort	<file-name> cannot be opened.
E 1511	File load error. Abort	An error occurred during file reading or writing.
E 1512	Memory cannot be allocated.	Confirm that sufficient memory capacity is available in Windows.
E 1513	Memory reallocation error	Confirm that sufficient memory capacity is available in Windows.
E 1514	Check sum error. Continue?	It was detected that the checksum of the program file opened by the HEX editor was invalid. Click OK to continue checksum verification. Click Cancel to abort checksum verification.
E 1515	Cannot open <file name> Abort.	The program file specified by the HEX editor cannot be opened.
E 1516	Error line : <line number> Data error. Abort DATA Check	An illegal data exists in line <i>line-number</i> in the program file.
E 1517	Shortage of memory.	Confirm that sufficient memory capacity is available in Windows.
E 1518	Invalid file name.	The file name is invalid.
E 1519	HEX format error.	An illegal program file format was detected.
E 1520	Too large address.	The address is too large. The maximum address that can be used by the HEX Editor is 420000h.
E 1521	Can not run <command name>	Running of the <i>command-name</i> command has failed.
E 1522	Illegal address	The range of the data storage address is invalid. The start address may be larger than the end address.
E 1523	<file name> could not be opened. Abort Save File	<file-name> cannot be opened. File saving was aborted.
E 1524	Data error. Abort DATA Check	A data error has been found in the program file. Data checking was aborted.
E 1525	Temporary file could not be read. Abort Save File	Opening of the temporary file has failed. The file may be corrupted.

(3/3)

No.	Message	Description
E 1526	Error line : <line number> Data Count error. Abort "Data Count Check"	A data count error has occurred in line <i>line-number</i> . The program file format may be incorrect.
E 1527	Cannot open temporary file.	Opening of the temporary file has failed. The file may be corrupted.
E 1528	File Save error. Abort "Save File"	Saving the file has failed.
E 1529	<line number> Check sum error. Continue ?	A checksum error has occurred in line <i>line-number</i> . The program file format may be incorrect. Select whether to continue the operation.
E 1530	Too large address. Edit range: 0 - 0x420000	The program file address is too large. Set an address value in the range 0 to 420000h.
E 1531	Data Flash format error: <data address>: Invalid ID Tag.	The data flash format is invalid. Valid 4 bytes are followed by an ID tag of 4-byte FFh or 4-byte 00h in the data flash area. An error occurs if the ID tag includes defects, or FFh or 00h is included.
E 1532	Parameter of "Start Address" is invalid.	The value input as the start address is not a valid hexadecimal number.
E 1533	Parameter of "End Address" is invalid.	The value input as the end address is not a valid hexadecimal number.
E 1534	Temporary file could not be read. Abort Dump Hex	The temporary file cannot be read. Opening of the HEX Editor was aborted.
E 1535	Can not open <file name> Abort 'Dump Hex'	<file-name> cannot be opened. Opening of the HEX Editor was aborted.
E 1536	File load error. Abort 'Dump Hex'	A file load error. Opening of the HEX Editor was aborted.
E 1537	Error line : <line number > Check sum error. Abort "Check sum" Check	An incorrect checksum was detected in line <i>line-number</i> in the program file. The program file format may be incorrect.
E 1538	Can not read temporary file.	Reading of the temporary file has failed. The file may be corrupted.
E 1539	Caution: Out of range!	The specified value is out of the valid range.
E 1601	Protect error.	The on-chip debug security ID and option byte settings cannot be read because read-prohibited has been specified.

A.3 Information Dialog Boxes for Programming GUI Operation

(1/3)

No.	Message	Description
I 2100	Please setup host connection again.	After FP5 reset, communication with FP5 was attempted but failed. Try [Programmer] - [Setup host connection] in the menu.
I 2200	Please open 'Setup' form menu. It will help you down load parameter & setting files	Open [Setup] in the menu and then download the PR5 or ESF file.
I 2201	Parameter/setting files are not matched.	Information does not match the one defined in the PR5/ESF file. The cause may be the following: 1. The PR5 or ESF file, which is defined in the INI file, is different from the one stored in the FP5. 2. Information on the PR5 or ESF file is missing in the INI file, but a valid PR5 or ESF file is stored in the FP5. 3. No PR5 or ESF file is stored in the FP5, but valid PR5 or ESF file has been detected because they are defined in the INI file.
I 2202	Parameter/setting files are not find.	The PR5 or ESF file is missing. No valid PR5 or ESF file is defined in the INI file. Store a valid PR5 or ESF file in <i>installation-folde\FP5_PRJ</i> .
I 2203	Are you sure, you want to update the Firmware?	Select whether to update the firmware. Click 'Ok' to update the firmware. Click Cancel to cancel the operation.
I 2204	Are you sure, you want to update the FPGA?	Select whether to update the FPGA. Click 'Ok' to update the FPGA. Click Cancel to cancel the operation.
I 2207	Do you really want change parameter area format? All data will lost after this action	Select whether to change the factor for dividing the programming area. After this operation, all data will be lost.
I 2208	Information defined in initial file is not enough or it is not matched with FlashProgrammer. Setup parameters is needed.	The settings in the ESF file are insufficient or do not match the settings made in the FP5. Device setup is required.
I 2209	Information defined in initial file is not complete matched with FlashProgrammer. Do you want to go Setup dialog?	The contents of the ESF file do not match those stored in the FP5. Select whether to open the Device Setup dialog box.
I 2210	Updating the firmware will take several minutes. ATTENTION: - The process of updating your firmware must NOT be interrupted! - Without firmware this FP5 GUI will NOT run properly. Install new firmware in your programmer?	The firmware update will take several minutes. ATTENTION: Firmware update cannot be aborted. The FP5 may not operate normally if proper firmware is not installed. Select whether to update the firmware.
I 2211	Updating the FPGA will take several minutes. ATTENTION: - The process of updating your FPGA must NOT be interrupted! - Without FPGA this FP5 GUI will NOT run properly. Install new FPGA in your programmer?	The FPGA update will take several minutes. ATTENTION: The FP5 may not operate normally if a proper FPGA is not installed. Select whether to update the FPGA.

(2/3)

No.	Message	Description
I 2212	You must be careful before start Self-test. ATTENTION: - Remove any plugs from Target- and Remote-connector before starting. - Any hardware attached to those connectors may be damaged by this test! Start Self-test?	Note the following points before performing self-testing. ATTENTION: Unplug all target connectors and remote connectors. If any hardware is connected, it may be damaged by this testing.
I 2213	Project folder and parameter file is not defined. Click button [Yes] if create the setting file newly Click button [No] if select the existing setting file	–
I 2214	Parameter setting file is not defined. use most recent setting as default	–
I 2215	Selected parameter files are copied to specified project folder.	User selected parameter files are copied to the destination.
I 2216	<Parameter file name> already exists. Do you want overwrites the existing file?	–
<R> I 2218	HEX File on local PC differs from FlashProgrammer contents. Setup of parameters is needed.	The program file is not sufficient, or does not match the FP5. Setup of the device is required.
I 2300	Value out of range.	The set value is out of the valid ranges. The valid code flash range is 0-0x400000. The valid data flash range is 0x400000 to 0x420000.
I 2302	Please give file range	Input the file range. No arguments are specified for the range.
<R> I 2401	Caution: When 'Chip Erase' is disabled, chip cannot be erased and programmed any more!	If security setting is performed with chip erase prohibition enabled, the target device cannot be rewritten because chip erasure cannot be done.
<R> I 2402	Caution: When 'Boot block cluster reprogramming' is disabled, chip cannot be erased and programmed any more!	If security setting is performed with boot area rewrite prohibition enabled, the boot area of the target device cannot be rewritten.
<R> I 2403	Caution: When 'Block Erase' is disabled, chip cannot be erased and programmed any more!	If security setting is performed with block erase prohibition enabled, the target device cannot be rewritten because block erasure cannot be done.
I 2411	The selection is out of range.	The selected communication speed is higher than the maximum value defined in the PR5 file.
I 2412	The selection is out of range.	The selected communication speed is lower than the minimum value defined in the PR5 file.
I 2413	Value is out of range.	The selected clock value is larger than the maximum value defined in the PR5 file.
I 2414	Value is out of range.	The selected clock value is smaller than the minimum value defined in the PR5 file.
I 2415	The selection is out of range.	The V _{DD} value exceeds the range defined in the PR5 file.
I 2416	The selection is out of range.	The V _{DD2} value exceeds the range defined in the PR5 file.
I 2417	The selection is out of range.	The selected value is out of the valid range.
I 2418	Input data is out of range.	The selected clock value exceeds the range defined in the PR5 file.

(3/3)

No.	Message	Description
I 2419	Caution: Boot Block swapping will not be possible with this selection. Anyhow, boot block protection is possible.	Boot swapping is not available because the selected block number is larger than half the total block numbers defined in the PR5 file. Boot block protection can be enabled.
I 2420	Illegal OCD security ID setting.	The value in the [OCD Security ID Setting] box is illegal.
I 2421	Illegal option byte setting.	The value in the [Option bytes setting] box is illegal.
I 2500	Welcome to FP5 Manager! [Yes]:Continue to set FP5 Manager [No]:Return to Standard mode unsecured	–
I 2501	Initialize as shipment condition? Warning: After initialization all data and parameter settings in FP5 will be deleted.	–
I 2601	Buffer is modified. Are you sure to close?	The HEX Editor temporary file has been changed. This change is lost when the HEX Editor is closed.
I 2602	This file is not valid.	The file selected by the HEX Editor is invalid.
I 2603	End record not found, created.	The end record is missing. The HEX editor will add the HEX format end record ':00000001FF' to the file.
I 2604	Save?	Select whether to save the data. Click 'Ok' to save the data. Click 'Cancel' to not save the data.
I 2605	The file is modified. Are you sure to quit?	The file has been modified. Select whether to abort the operation. Click 'Yes' to abort without saving changes. Click 'No' to continue the operation.
I 2606	The file is modified. Save file?	The file has been modified. Select whether to save changes.

A.4 Error Messages Displayed in FP5 Message Display

(1/3)

No.	Message	Error Condition	Possible Workaround
<R> 001	Invalid PRM data	Invalid PRM data	The parameter file may include invalid data, or the file may be defective. Perform setting again by using the correct PR5 file.
002	Not connected	No device connected to FP5	Issue a 'con' command before the command causing this error.
005	Not supported!	–	The command issued is not supported on the device and thus cannot be used.
006	Command aborted!	Command aborted	The [Read] command has been canceled.
008	Parameter Error!	PR5 file Error	The parameter file may be damaged.
011	Read. Sig failed	Device signature reading failed	Check if the correct device is selected.
012	Check connection	Connection check	The FP5 cannot establish connection to the target device. The cause may be a wrong connection between the device and the FP5, bad socket contacts or the oscillator not operating.
013	Addr. Range err	Address range error	The address given in the command exceeds the device's address range.
014	RDY detect. fail	Device does not send RDY signal.	Wrong connection between device and FP5 or bad socket contacts.
015	Freq. set failed	Setting the Oscillator frequency failed.	Check if the oscillator frequency is allowed. If yes, contact Renesas Electronics support desk.
016	Baudrt. set fail	Setting the communication baud rate failed.	Unsupported baud rate specified. Please consult the device manual.
<R> 017	ID coe chk. err	ID code does not match.	Set the security ID specified for the target device.
020	Inv. Sig. ID	Invalid signature ID	Check if the correct device is selected.
021	Inv. Sig. Code	Invalid signature code	Check if the correct device is selected.
022	Inv. Sig. func.	Invalid signature function	Check if the correct device is selected.
023	Inv. Sig. addr.	Invalid signature address	Check if the correct device is selected.
024	Inv. device name	Invalid device name	Check if the correct device is selected.
025	Inv. Signature	Invalid signature	Check if the correct device is selected.
026	Inv Dev/Firm ver	Invalid device firmware version	Check if the correct device is selected.
027	Unkn. Signature	Unknown Signature	Check, if the correct PRM file is used.
<R> 029	Inv. DeviceInfo	Invalid device information	Check if the correct device is selected.
030	Prewrite Timeout	Prewrite timed out	A communication problem occurred between the FP5 and target device. Try the operation again.
032	Prewrite failed	Prewrite retry error	The device may be damaged.
040	Erase Timeout	Erase timed out	A communication problem occurred between the FP5 and target device. Try the operation again.
041	Erase failure	Erase failed	The device may be damaged.
042	Ers time exceed	Erase timed out	The device may be damaged.
043	Ers Timeset err	Erase time setting error	The PR5 file may contain invalid data. Contact Renesas Electronics.

(2/3)

No.	Message	Error Condition	Possible Workaround
050	Bln Timeout	Blank check timed out	A communication problem occurred between the FP5 and target device. Try the operation again.
051	Blank chk failed	Blank check failed	The device connected is not empty. Use the 'erase' command before programming.
<R> 060	Wrb Timeout	Writeback timed out	There was a communication problem between the FP5 and target device. Or the device may be defective.
061	Writeback failed	Writeback failed	A device defect is most probably causing this error.
062	Wrb retry exceed	Writeback retry timed out	A device defect is most probably causing this error.
063	Wrb Timeset err	Writeback time setting error	The parameter file may contain invalid data. Contact Renesas Electronics.
070	Write timeout	Write timed out	There was a communication problem between the FP5 and target device. Try the operation again.
071	Write failed	Write operation failed	Either the device was not blank before writing or a device defect is causing this error.
072	Write retry err	Write retry error	Either the device was not blank before writing or a device defect is causing this error.
073	Wrt. Timeset err	Write time setting error	The parameter file may contain invalid data. Contact Renesas Electronics.
080	Vrf Timeout	Verify timed out	There was a communication problem between the FP5 and target device. Try the operation again.
081	Verify failed	Verify failed	The data in the target device's flash memory is not the same as in the FP5.
090	IVrf Timeout	Internal verify timed out	There was a communication problem between the FP5 and target device. Try the operation again.
091	IVerify failed	Internal verify error	An error was occurred while the write data level was being checked.
092	VGT Comm err	Device communication error	The FP5 is not communicating properly with the target device. Check that the FP5 is correctly connected to the target device.
093	SUM Comm err	Device communication error	The FP5 is not communicating properly with the target device. Check that the FP5 is correctly connected to the target device.
<R> 094	SCF Comm err	Device communication error	The FP5 is not communicating properly with the target device. Check that the FP5 is correctly connected to the target device. It is displayed when security setting is changed from prohibition to permission. Set security setting to permission by chip erasure.
<R> 099	READ Comm err	Device communication error	It is a problem of communication between the FP5 and target device. Improve the connection environment between the FP5 and the device. It is displayed when read prohibition is set in security setting. Set read permission by chip erasure.
204	Not connected	The target device was not connected to FP5 when a 'disconnect' command was issued.	–
210	Already conn.	A connect command was issued when the target device was already connected to FP5.	–

(3/3)

No.	Message	Error Condition	Possible Workaround
<R> 301	Security ID err	Security ID does not match.	Set the security ID specified for the target device.
302	HEX range err	Program file size error	The address range of the downloaded program file is outside the address range set in the [Operation Mode] area on the [Standard] tab of the Device Setup dialog box.
400	Targ. power det.	Target power detected! Check Setup.	FP5 should supply V _{DD} power, but supply voltage has been detected to be already present on the target board. Please change Setup (uncheck: V _{DD} : On Target).
401	FP5 int Vpp fail	FP5 Power failure.	Please contact Renesas Electronics support desk.
402	FP5 int Vdd fail	FP5 Power failure.	Please contact Renesas Electronics support desk.
403	FP5 int Vdd2 fail	FP5 Power failure.	Please contact Renesas Electronics support desk.
404	Targ. power fail	No V _{DD} applied or Voltage is out of range.	V _{DD} is supplied from target board, but V _{DD} voltage does not match the V _{DD} value in FP5 Setup. Check, if the V _{DD} power settings are OK.
405	Power failure	A supply voltage failure has been detected.	There is possibly a shortcut in the target hardware.
590	IDC Comn err	Device communication error or illegal OCD security ID setting	The FP5 is not communicating properly with the target device. Check that the FP5 is correctly connected to the target device. Also check that the on-chip debug security ID is correct.
591	OPB Comn err	Device communication error or illegal OCD security ID setting	The FP5 is not communicating properly with the target device. Check that the FP5 is correctly connected to the target device. Also check that the on-chip debug security ID is correct.

APPENDIX B SUPPLEMENTARY INFORMATION

Figure B-1. Relationship Between HEX Editor and Saved Program File

<HEX Editor>																		
address	+0	+1	+2	+3	+4	+5	+6	+7	+8	+9	+A	+B	+C	+D	+E	+F	ID	Tag
400000	00	11	22	33	44	55	66	77	88	99	AA	BB	CC	DD	EE	FF	1	1 0 0
<Saved program file>																		
address	Data Flash				ID Tag				Data Flash				ID Tag					
400000h	00	11	22	33	FF	FF	FF	FF	44	55	66	77	FF	FF	FF	FF		
400010h	88	99	AA	BB	00	00	00	00	CC	DD	EE	FF	00	00	00	00		

Figure B-2. 32-bit CRC Calculation Specifications

```

/* The generator polynomial used for this table is */
/* x^32+x^26+x^23+x^22+x^16+x^12+x^11+x^10+x^8+x^7+x^5+x^4+x^2+x^1+x^0 */
/* according to Autodin/Ethernet/ADCCP protocol standards */
/* Binary: 0x04c11db7 */

const u32 CRC32_Tab [256]= {
0x00000000, 0x04c11db7, 0x09823b6e, 0x0d4326d9, 0x130476dc, 0x17c56b6b, 0x1a864db2, 0x1e475005,
0x2608edb8, 0x22c9f00f, 0x2f8ad6d6, 0x2b4bcb61, 0x350c9b64, 0x31cd86d3, 0x3c8ea00a, 0x384fdbbd,
0x4c11db70, 0x48d0c6c7, 0x4593e01e, 0x4152fda9, 0x5f15adac, 0x5bd4b01b, 0x569796c2, 0x52568b75,
0x6a1936c8, 0x6ed82b7f, 0x639b0da6, 0x675a1011, 0x791d4014, 0x7ddc5da3, 0x709f7b7a, 0x745e66cd,
0x9823b6e0, 0x9ce2ab57, 0x91a18d8e, 0x95609039, 0x8b27c03c, 0x8fe6dd8b, 0x82a5fb52, 0x8664e6e5,
0xbe2b5b58, 0xbaea46ef, 0xb7a96036, 0xb3687d81, 0xad2f2d84, 0xa9ee3033, 0xa4ad16ea, 0xa06c0b5d,
0xd4326d90, 0xd0f37027, 0xddb056fe, 0xd9714b49, 0xc7361b4c, 0xc3f706fb, 0xceb42022, 0xca753d95,
0xf23a8028, 0xf6fb9d9f, 0xfbb8bb46, 0xff79a6f1, 0xe13ef6f4, 0xe5ffeb43, 0xe8bccd9a, 0xec7dd02d,
0x34867077, 0x30476dc0, 0x3d044b19, 0x39c556ae, 0x278206ab, 0x23431b1c, 0x2e003dc5, 0x2ac12072,
0x128e9dcf, 0x164f8078, 0x1b0ca6a1, 0x1fcdbb16, 0x018aeb13, 0x054bf6a4, 0x0808d07d, 0x0cc9cdca,
0x7897ab07, 0x7c56b6b0, 0x71159069, 0x75d48dde, 0x6b93ddd, 0x6f52c06c, 0x6211e6b5, 0x66d0fb02,
0x5e9f46bf, 0x5a5e5b08, 0x571d7dd1, 0x53dc6066, 0x4d9b3063, 0x495a2dd4, 0x44190b0d, 0x40d816ba,
0xaca5c697, 0xa864db20, 0xa527fd9, 0xa1e6e04e, 0xbfa1b04b, 0xbb60adfc, 0xb6238b25, 0xb2e29692,
0x8aad2b2f, 0x8e6c3698, 0x832f1041, 0x87ee0df6, 0x99a95df3, 0x9d684044, 0x902b669d, 0x94ea7b2a,
0xe0b41de7, 0xe4750050, 0xe9362689, 0xedf73b3e, 0xf3b06b3b, 0xf771768c, 0xfa325055, 0xfef34de2,
0xc6bcf05f, 0xc27dede8, 0xcfc3ecb31, 0xcbf6d686, 0xd5b88683, 0xd1799b34, 0xdc3abded, 0xd8fba05a,
0x690ce0ee, 0x6dcdfd59, 0x608edb80, 0x644ffc637, 0x7a089632, 0x7ec98b85, 0x738aad5c, 0x774bb0eb,
0x4f040d56, 0x4bc510e1, 0x46863638, 0x42472b8f, 0x5c007b8a, 0x58c1663d, 0x558240e4, 0x51435d53,
0x251d3b9e, 0x21dc2629, 0x2c9f00f0, 0x285e1d47, 0x36194d42, 0x32d850f5, 0x3f9b762c, 0x3b5a6b9b,
0x0315d626, 0x07d4cb91, 0x0a97ed48, 0x0e56f0ff, 0x1011a0fa, 0x14d0bd4d, 0x19939b94, 0x1d528623,
0xf12f560e, 0xf5ee4bb9, 0xf8ad6d60, 0xfc6c70d7, 0xe22b20d2, 0xe6ea3d65, 0xeba91bbc, 0xef68060b,
0xd727bbb6, 0xd3e6a601, 0xdea580d8, 0xda649d6f, 0xc423cd6a, 0xc0e2d0dd, 0xcda1f604, 0xc960ebb3,
0xbd3e8d7e, 0xb9ff90c9, 0xb4bcb610, 0xb07ddab7, 0xae3afba2, 0xaaafbe615, 0xa7b8c0cc, 0xa379dd7b,
0x9b3660c6, 0x9ff77d71, 0x92b45ba8, 0x9675461f, 0x8832161a, 0x8cf30bad, 0x81b02d74, 0x857130c3,
0x5d8a9099, 0x594b8d2e, 0x5408abf7, 0x50c9b640, 0x4e8ee645, 0x4a4ffbf2, 0x470cdd2b, 0x43cdc09c,
0x7b827d21, 0x7f436096, 0x7200464f, 0x76c15bf8, 0x68860bfd, 0x6c47164a, 0x61043093, 0x65c52d24,
0x119b4be9, 0x155a565e, 0x18197087, 0x1cd86d30, 0x029f3d35, 0x065e2082, 0x0b1d065b, 0x0fdbc1bec,
0x3793a651, 0x3352bbe6, 0x3e119d3f, 0x3ad08088, 0x2497d08d, 0x2056cd3a, 0x2d15ebe3, 0x29d4f654,
0xc5a92679, 0xc1683bce, 0xcc2b1d17, 0xc8ea00a0, 0xd6ad50a5, 0xd26c4d12, 0xdf2f6bcb, 0xdbee767c,
0xe3a1cbc1, 0xe760d676, 0xea23f0af, 0xee2ed18, 0xf0a5bd1d, 0xf464a0aa, 0xf9278673, 0xfde69bc4,
0x89b8fd09, 0x8d79e0be, 0x803ac667, 0x84fbbdb0, 0x9abc8bd5, 0x9e7d9662, 0x933eb0bb, 0x97ffad0c,
0xafb010b1, 0xab710d06, 0xa6322bdf, 0xa2f33668, 0xbcb4666d, 0xb8757bda, 0xb5365d03, 0xb1f740b4
};

<R> u32 CRC_accum=0xffffffff;

void Gen_CRC_Sum_Char (u08 c)
{
s32 i;

/* Ignore '=', SPACE, CR, LF */
if ((c == '=') || (c == ' ') || (c == '\r') || (c == '\n'))
return;

/* Perform CRC sum algorithm (use table for better speed) */
i = ((CRC_accum >> 24) ^ (u32) c) & 0xff;
CRC_accum = (CRC_accum << 8) ^ CRC32_Tab [i];
}

```

Figure B-3. Log File Example

```

-----
Thu Aug 02 14:11:46 2007

-----Start record file-----
>ep
Blank check Chip:
ERROR(E051): Not blank, Erase
needed.
Erase Chip:
PASS
Program Chip:
10%
20%
30%
40%
50%
60%
70%
80%
90%
100%
PASS
Erase,Program operation
finished.
>
-----End record file-----
>
Thu Aug 02 14:12:03 2007
-----

```

Figure B-4. Division (Original) Calculation Specifications

```

#define BLOCKSIZ 256

/* You have to store 1-Block ROM data. */
unsigned char rom_data[BLOCKSIZ];

unsigned char
bist_calc()
{
    int i;
    unsigned short bist, bist_temp;

    bist = 0;
    for(i = 0; i < BLOCKSIZ; i++){
        bist_temp = bist & 0x1;
        bist_temp = (bist_temp << 8) | (bist_temp << 9) |
                    (bist_temp << 11) | (bist_temp << 12);
        bist = (bist >> 1) ^ rom_data[i] ^ bist_temp;
    }
    return((unsigned char)bist);
}

```

APPENDIX C ELECTRICAL SPECIFICATIONS OF TARGET INTERFACE

C.1 Absolute Maximum Ratings ($T_A = 0$ to 40 °C)

Pin name	Symbol	Parameter or Conditions	Ratings	Unit
V_{DD} V_{DD2}	–	Input supply voltage	–0.5 to +6.8	V
V_{PP}	V_o	Output supply voltage	–0.5 to +13	V
FLMD0 FLMD1 RESET SI/RxD SO/TxD SCK H/S CLK RFU-1 VDE	V_i	Input voltage	–0.5 to $+V_{DD}+0.5$ V ^{Note}	V
V_{DD} V_{DD2} V_{PP}	I_o	Output current	+500	mA
FLMD0	I_i	Input current (-0.5 V < V_i < $V_{DD}+0.5$ V)	±20	mA
FLMD1 RESET SI/RxD SO/TxD SCK H/S CLK	I_o	Output current (0.3 V < V_o < $V_{DD}+0.5$ V)	±35	mA
	T_A	Operating ambient temperature	0 to 40	°C
	T_{stg}	Storage temperature	–15 to +60	°C

Note Must be less than 6.8 V.

Caution Product quality may suffer if the absolute maximum rating is exceeded even momentarily for any parameter. That is, the absolute maximum ratings are rated values at which the product is on the verge of suffering physical damage, and therefore the product must be used under conditions that ensure that the absolute maximum ratings are not exceeded.

C.2 DC Characteristics ($T_A = 0$ to 40 °C)

(1/2)

Pin name	Symbol	Parameter or Conditions	MIN.	TYP.	MAX.	Unit
V_{DD}	V_{OH}	Output voltage, high	1.2		5.5	V
V_{DD2}		Output voltage accuracy, high ($I_{OH} = 100$ mA)	Setting value ^{Note} -5%	Setting value ^{Note}	Setting value ^{Note} +5%	V
V_{PP}	V_{OL}	Output voltage, low	0		5.5	V
	V_{OH}	Output voltage, high	1.2		12	V
FLMD0	V_{OL1}	Output voltage, low ($I_{OL} = 100$ μ A)		0	0.2	V
FLMD1	V_{OL2}	Output voltage, low ($V_{DD} = 3.0$ V, $I_{OL} = 8$ mA)		0.5	0.7	V
RESET						
SO/TxD	V_{OL3}	Output voltage, low ($V_{DD} = 4.5$ V, $I_{OL} = 16$ mA)		0.9	1.1	V
SCK						
CLK	V_{OH1}	Output voltage, high ($I_{OH} = 100$ μ A)	$V_{DD} - 0.2$	V_{DD}		V
	V_{OH2}	Output voltage, high ($V_{DD} = 3.0$ V, $I_{OH} = 8$ mA)	2.1	2.6		V
	V_{OH3}	Output voltage, high ($V_{DD} = 4.5$ V, $I_{OH} = 16$ mA)	3.1	3.7		V
SI/RxD	I_{IL}	Input voltage, low			$V_{DD} \times 0.30$	V
H/S	I_{IH}	Input voltage, high	$V_{DD} \times 0.75$			V

Note The setting value in the [Vdd[V]] box and [Vdd2[V]] box on the [Advanced] tab of the Device Setup dialog box

(2/2)

Pin name	Symbol	Parameter or Conditions	MIN.	TYP.	MAX.	Unit
V_{DD}	I_{OH1}	Output current, high ($V_{DD} = 1.2$ V)			+100	mA
V_{DD2}	I_{OH2}	Output current, high ($V_{DD} = 3.3$ V)			+300	mA
	I_{OH3}	Output current, high ($V_{DD} = 5.0$ V)			+350	mA
	I_{IH}	Input current, high			+10	mA
V_{PP}	I_{OH}	Output current, high			+200	mA
FLMD0	I_{OL}	Output current, low			-16	mA
FLMD1	I_{OH}	Output current, high			+16	mA
RESET						
SO/TxD						
SCK						
H/S						
CLK						
SI/RxD	I_{LIL}	Input leakage current, low			-10	μ A
H/S	I_{LIH}	Input leakage current, high			+100	μ A

C.3 AC Characteristics (T_A = 0 to 40 °C, C = 0 pF (Unloaded Condition))

(1/2)

Pin name	Symbol	Parameter or Conditions	MIN.	TYP.	MAX.	Unit
V _{DD} V _{DD2}	t _{PLHVD}	Rise time (V _{DD} = 5.0V, I _{OH} = 200 mA)			300	μs
		Rise time (V _{DD} = 3.3 V, I _{OH} = 200 mA)			700	μs
	t _{STBVD}	V _{DD} /V _{DD2} stabilization time			200	ms
V _{PP}	t _{PHLVP}	Rise time			5	μs
FLMD0	t _{PLHMD}	Rise time			20	ns
	t _{PHLMD}	Fall time			20	ns
	t _{WHMD}	High-level width	Note	50	Note	μs
	t _{WLMD}	Low-level width	Note	50	Note	μs

Note The minimum value (MIN.) and the maximum value (MAX.) are determined depend on parameter file. (MIN. = 1 μs, MAX. = 999×10⁹ μs)

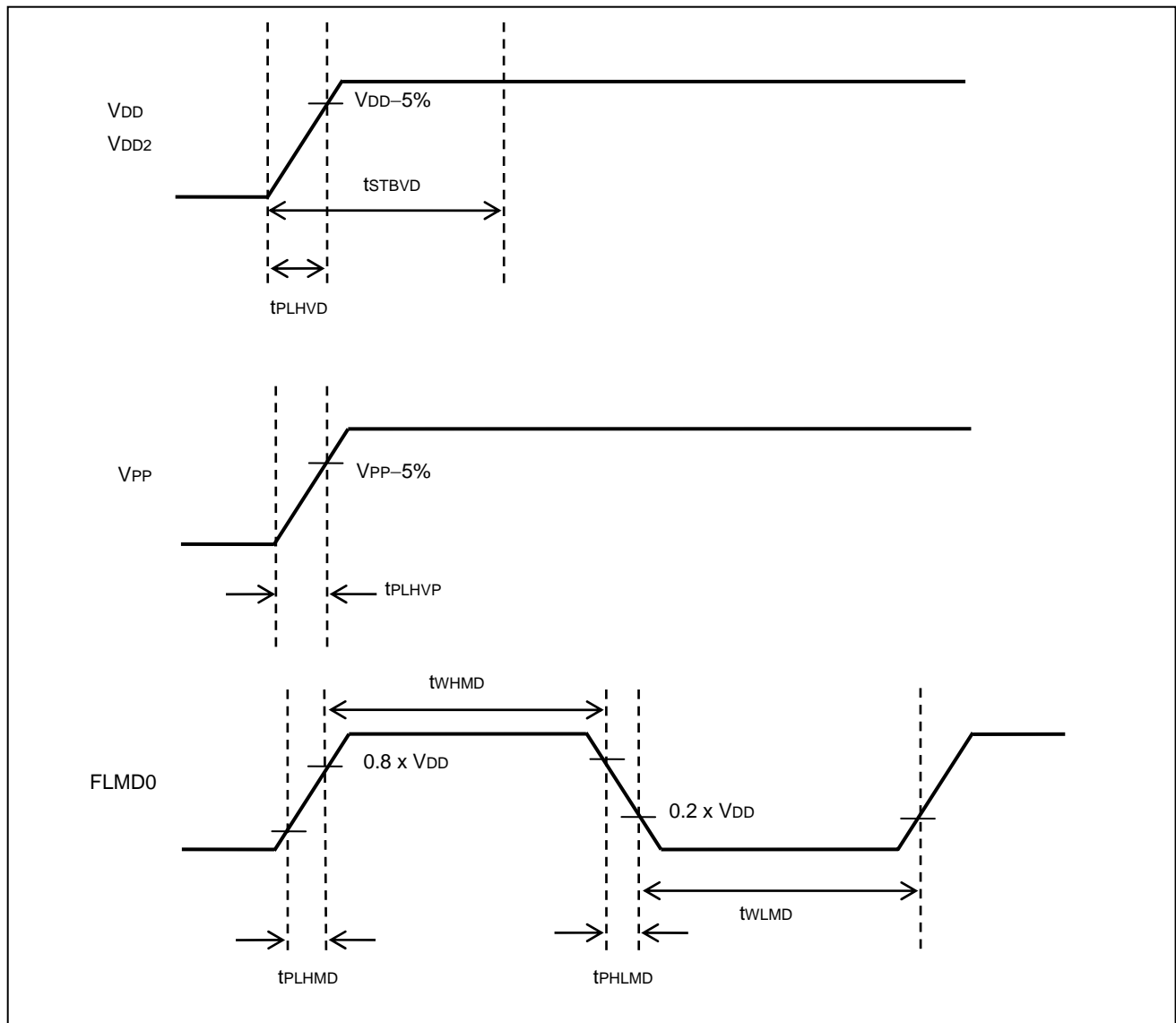

(2/2)

Pin name	Symbol	Parameter or Conditions	MIN.	TYP.	MAX.	Unit
RESET	t _{PLHRS}	Rise time (C = 0 pF)	20			ns
	t _{DRS}	Reset release maximum delay time			Note	ns

Note $(t_{RPE} - t_{RP}) / 2 - FLMD0 \times 100 \mu s$

t_{RP} : Device firmware FLMD0 Count start time

t_{RPE} : Device firmware FLMD0 Count finish time

The maximum number of FLMD pulses is 15.

For the characteristics of t_{RP}, t_{RPE}, and FLMD0 pulses, refer to the parameter specifications in the manual of the target manual.

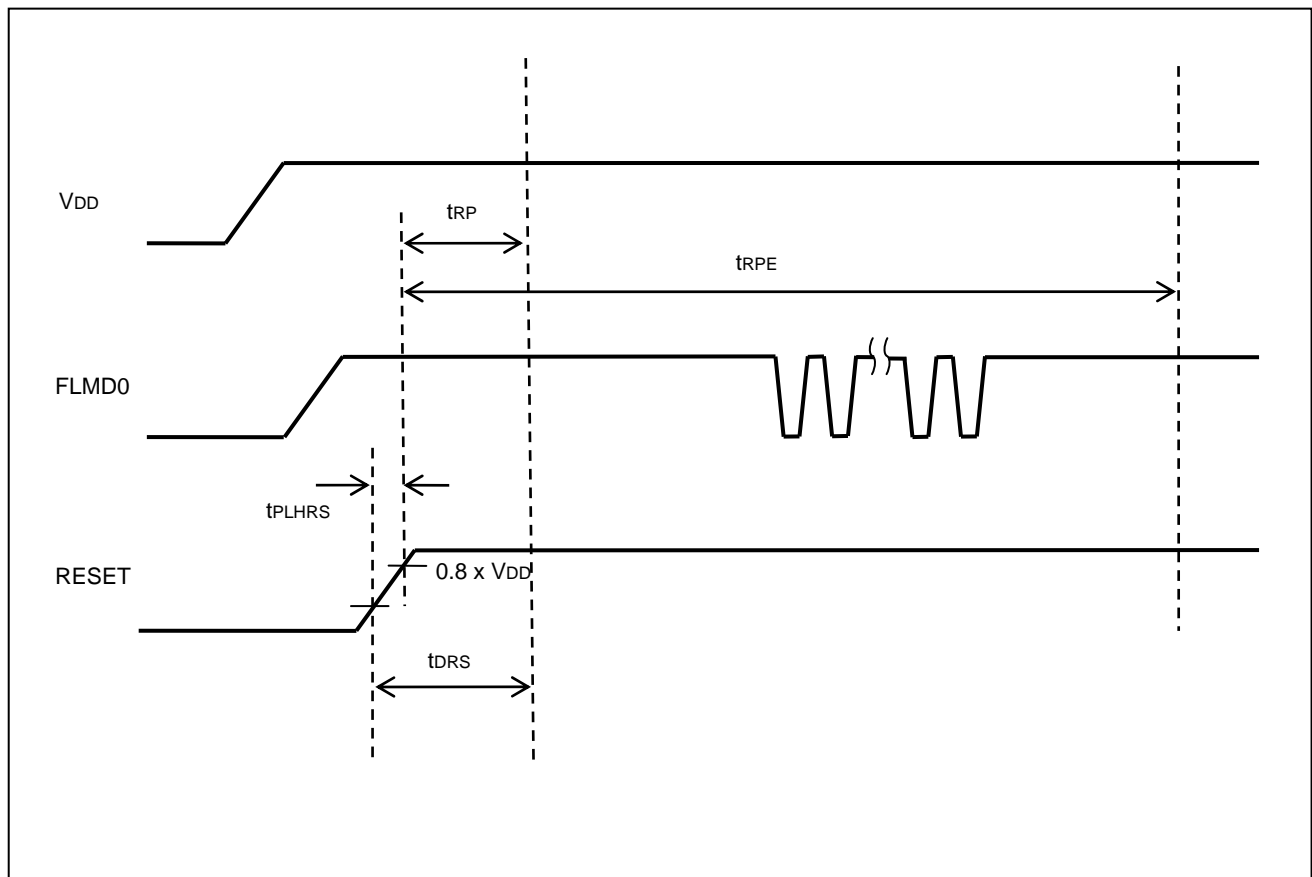

C.3.1 CLK output characteristics (T_A = 0 to 40 °C, C = 0 pF (unloaded condition))

Pin name	Symbol	Parameter or Conditions	MIN.	TYP.	MAX.	Unit
CLK	t _{CKCY}	Clock output frequency	1		20	MHz
	t _{WHCK}	High-level width	10.0		490	ns
	t _{WLCK}	Low-level width	10.0		490	ns
	t _{PLHCK}	Rise time	3.4		16	ns
	t _{PHLCK}	Fall time	4.2		12	ns

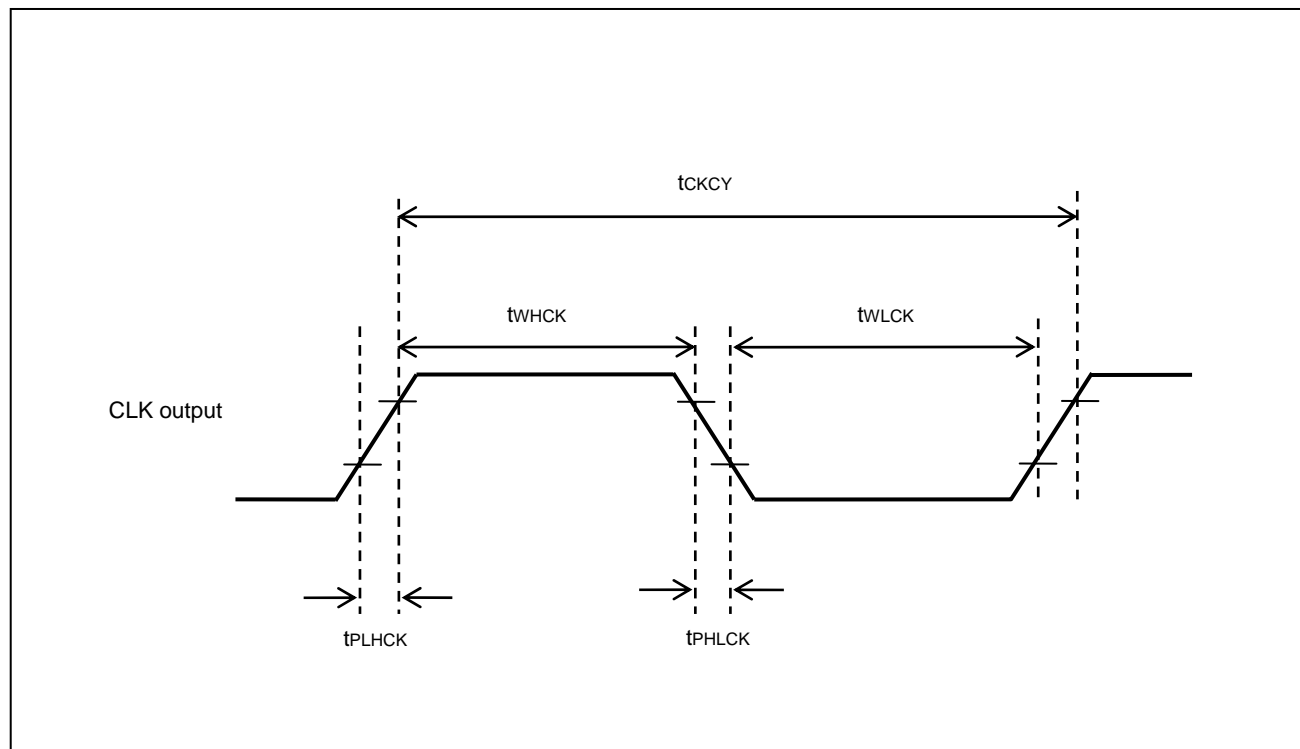

C.3.2 Serial transfer timing (T_A = 0 to 40 °C, C = 0 pF (unloaded condition))

Pin name	Symbol	Parameter or Conditions	MIN.	TYP.	MAX.	Unit
SCK	t _{SCCY}	Serial clock output frequency	9.8		5000	kHz
	t _{WHSC}	High-level width	85		50000	ns
	t _{WLSC}	Low-level width	85		50000	ns
	t _{PLHSC}	SI setup time (to SCK↑)	80			ns
	t _{PHLSC}	SI hold time (from SCK↑)	0			ns
	t _{DSC}	Delay time from SO output			20	ns
			Transfer rate in UART	9600		1000

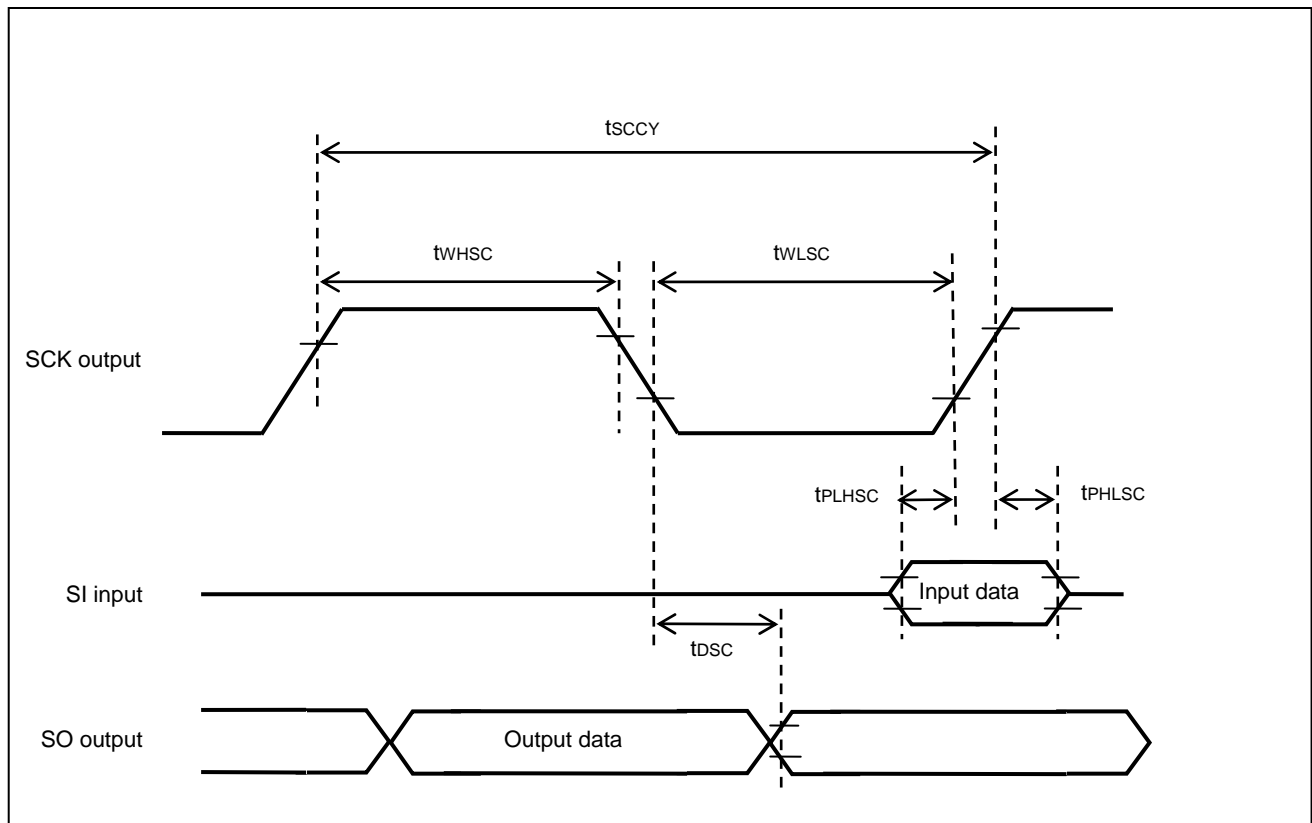

APPENDIX D ELECTRICAL SPECIFICATIONS OF REMOTE INTERFACE

D.1 Absolute Maximum Ratings ($T_A = 0$ to 40 °C)

Pin name	Symbol	Parameter or Conditions	Ratings	Unit
CONN	V_o	Output supply voltage	-0.5 to +3.6	V
BUSY	V_i	Input voltage	-0.5 to +6.0	V
PASS	I_o	Output current ($0 \text{ V} \leq V_o \leq 3.6 \text{ V}$)	± 35	mA
ERROR		Output current ($-0.5 \text{ V} \leq V_o < 0 \text{ V}$)	-50	mA
CANCEL ENTER NEXT VRF START CLEAR	I_{ik}	Input current ($V_i < 0 \text{ V}$)	-20	mA

Caution Product quality may suffer if the absolute maximum rating is exceeded even momentarily for any parameter. That is, the absolute maximum ratings are rated values at which the product is on the verge of suffering physical damage, and therefore the product must be used under conditions that ensure that the absolute maximum ratings are not exceeded.

D.2 DC Characteristics (T_A = 0 to 40 °C, C = 0 pF (Unloaded Condition))

Pin name	Symbol	Parameter or Conditions	MIN.	TYP.	MAX.	Unit
CONN	V _{OH}	Output voltage, high (I _{OH} = 8 mA)	2.3	2.9		V
BUSY		Output voltage, high (I _{OH} = 50 μA)	3.0	3.3		V
PASS	V _{OL}	Output voltage, low (I _{OL} = 8 mA)		0.5	0.8	V
ERROR		Output voltage, low (I _{OH} = 50 μA)		0	0.1	V
CANCEL	V _{IH}	Input voltage, high	2.2			V
ENTER	V _{IL}	Input voltage, low			1.1	V
NEXT						
VRF						
START						
CLEAR						
CONN	I _{OH}	Output current, high			+8	mA
BUSY	I _{OL}	Output current, low			-8	mA
PASS						
ERROR						
CANCEL	I _i	Input current			±1	mA
ENTER						
NEXT						
VRF						
START						
CLEAR						

D.3 AC Characteristics (T_A = 0 to 40 °C, C = 0 pF (Unloaded Condition))

D.3.1 Standard mode

(1/2)

Pin name	Symbol	Parameter or Conditions	MIN.	TYP.	MAX.	Unit
CONN	t _{PLH}	Rise time (I _o = 8 mA)	5			ns
BUSY PASS ERROR	t _{PHL}	Fall time (I _o = 8 mA)	5			ns
CANCEL ENTER NEXT VRF START CLEAR	t _{PLIN}	Low-level width of the input signal	50			ms
	t _{PPOCN}	Time from switching on the FP5 POWER button until the rise of the CONN signal			8	s
	t _{PCNPO}	Time from switching off the FP5 POWER button until the fall of the CONN signal			1	s
	t _{PCNIN}	Time from the rise of the CONN signal until the input signal is acknowledged	1			ms

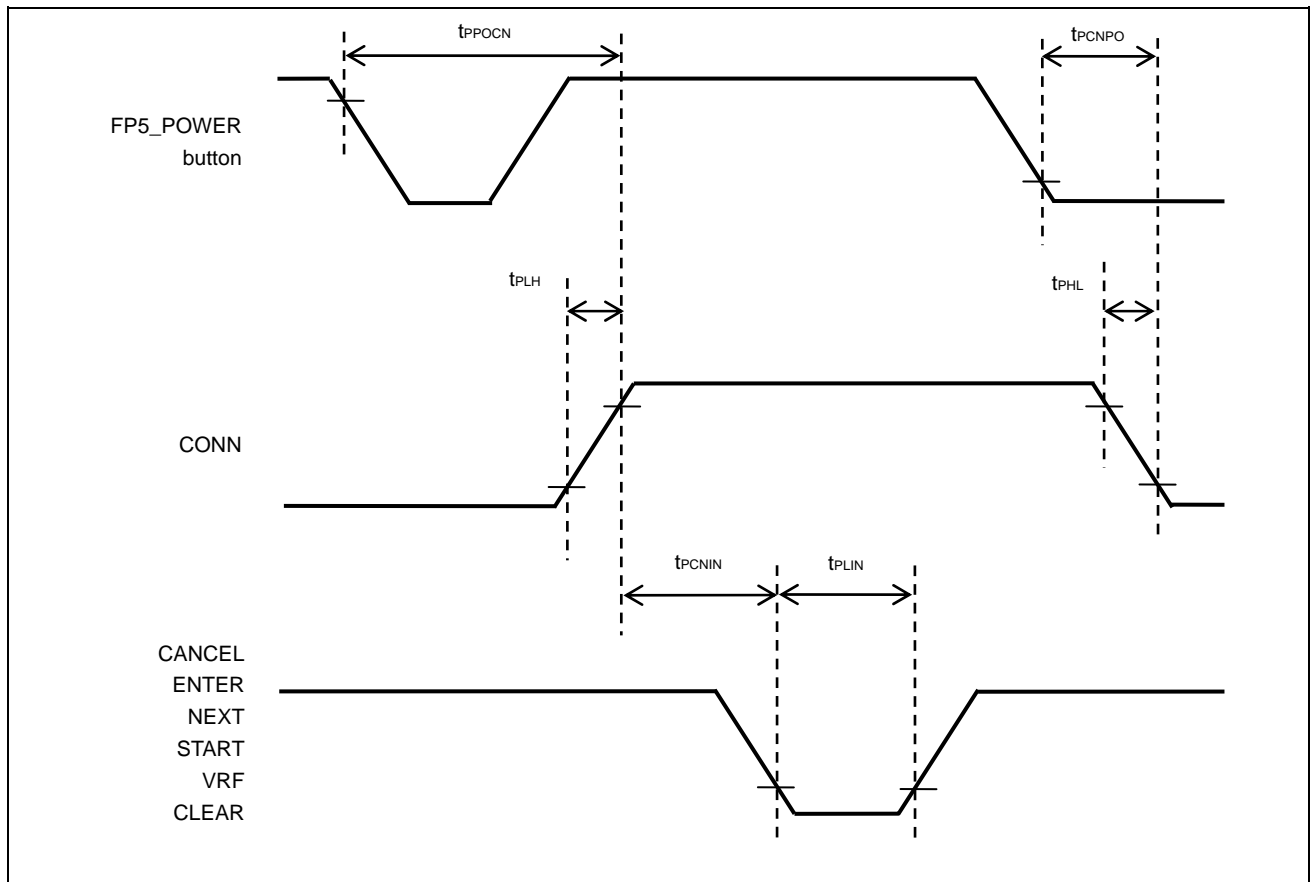

(2/2)

Pin name	Symbol	Parameter or Conditions	MIN.	TYP.	MAX.	Unit
	t_{PINBU}	Time from the fall of the VRF, START, or ENTER signal until the rise of the BUSY signal	50			ms
	t_{PBUIN}	Time from the fall of the BUSY signal until the CLEAR signal can be input	1			ms
	t_{PCLPE}	Time from the fall of the CLEAR signal until the fall of the PASS or ERROR signal	50			ms
	t_{PPEIN}	Time from the fall of the PASS or ERROR signal until the VRF, START, or ENTER signal can be input	1			ms

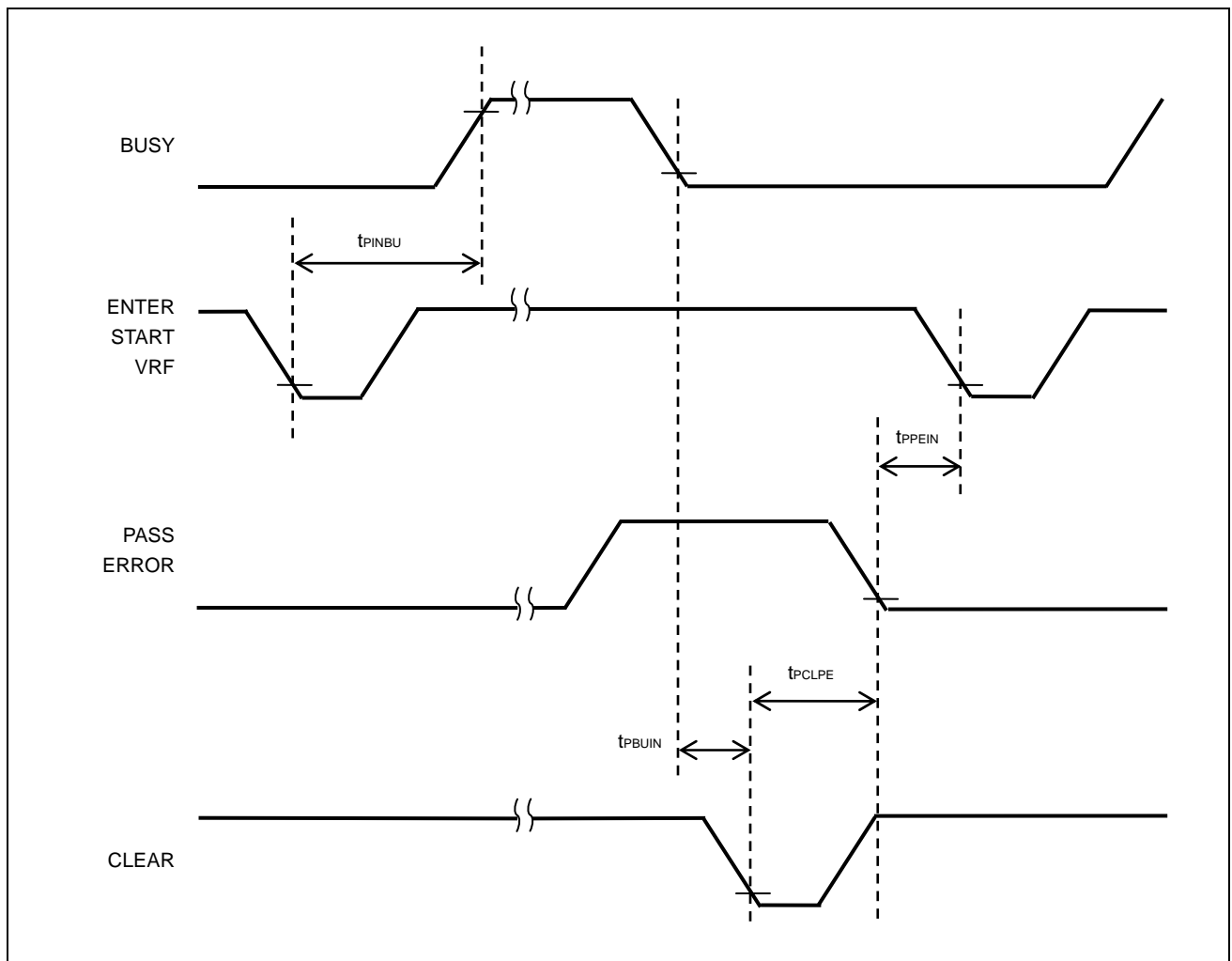

D.3.2 Bank mode

(1/2)

Pin name	Symbol	Parameter or Conditions	MIN.	TYP.	MAX.	Unit
CONN	t_{PLH}	Rise time ($I_o = 8\text{ mA}$)	5			ns
BUSY PASS ERROR	t_{PHL}	Fall time ($I_o = 8\text{ mA}$)	5			ns
BANK0 BANK1 BANK2 VRF START CLEAR	t_{PLIN}	Low-level width of input signal	50			ms
	t_{PPOCN}	Time from turning on the power of the FP5 until the rise of the CONN signal			8	s
	t_{PCNPO}	Time from turning off the power of the FP5 until the fall of the CONN signal			1	s
	t_{PCNIN}	Time from the rise of the CONN signal until the input signal is acknowledged	1			ms

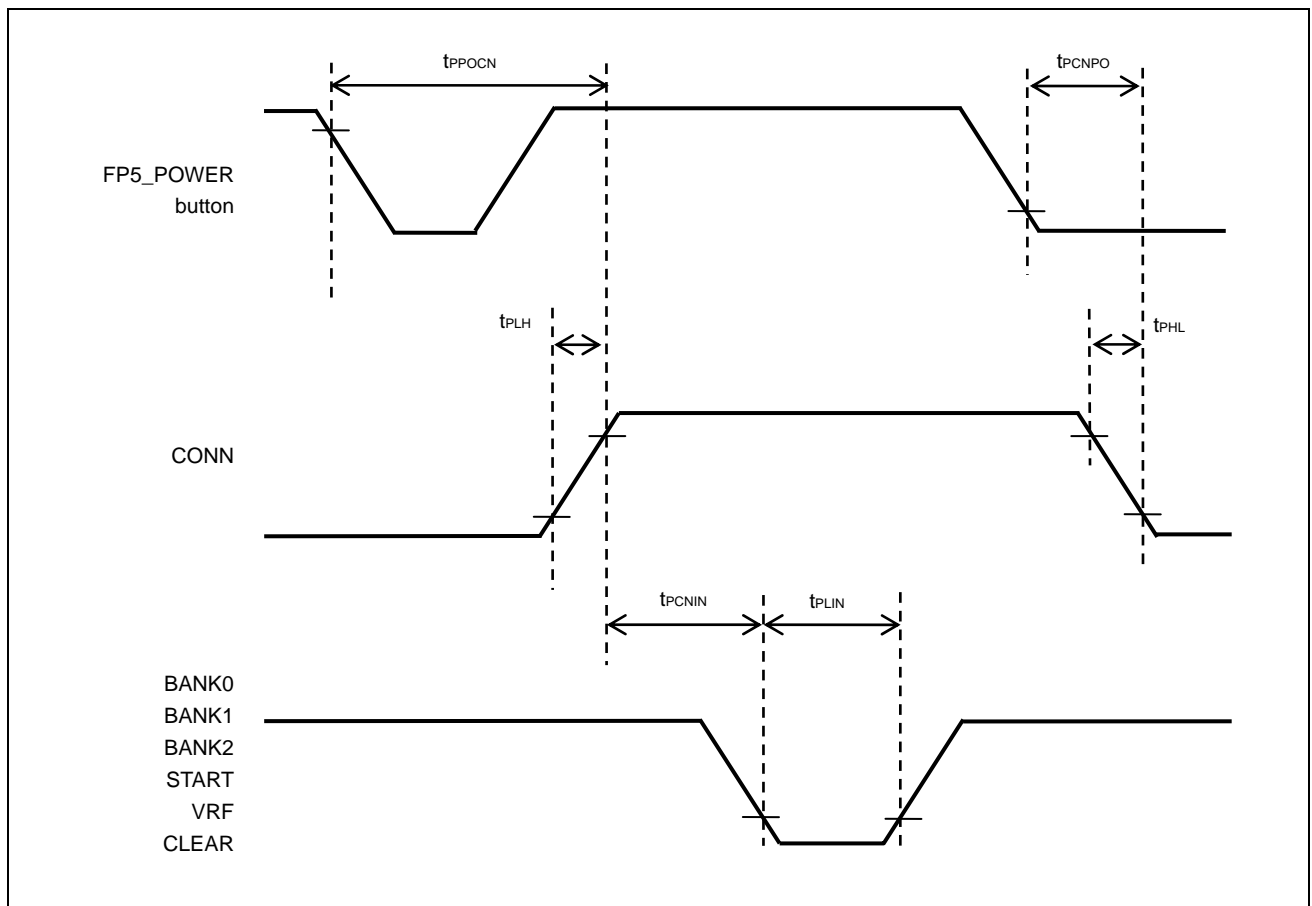

(2/2)

Pin name	Symbol	Parameter or Conditions	MIN.	TYP.	MAX.	Unit
	t_{PBAIN}	Time from the fall of the BANK signal until the VRF or START signal can be input	1			ms
	t_{PINBU}	Time from the fall of the VRF, START or ENTER signal until the rise of the BUSY signal	100			ms
	t_{PBUIN}	Time from the fall of the BUSY signal until the CLEAR signal can be input	5			ms
	t_{PCLPE}	Time from the fall of the CLEAR signal until the fall of the PASS or ERROR signal	50			ms
	t_{PPEBA}	Time from the fall of the PASS or ERROR signal until the BANK signal can be input	10			ms

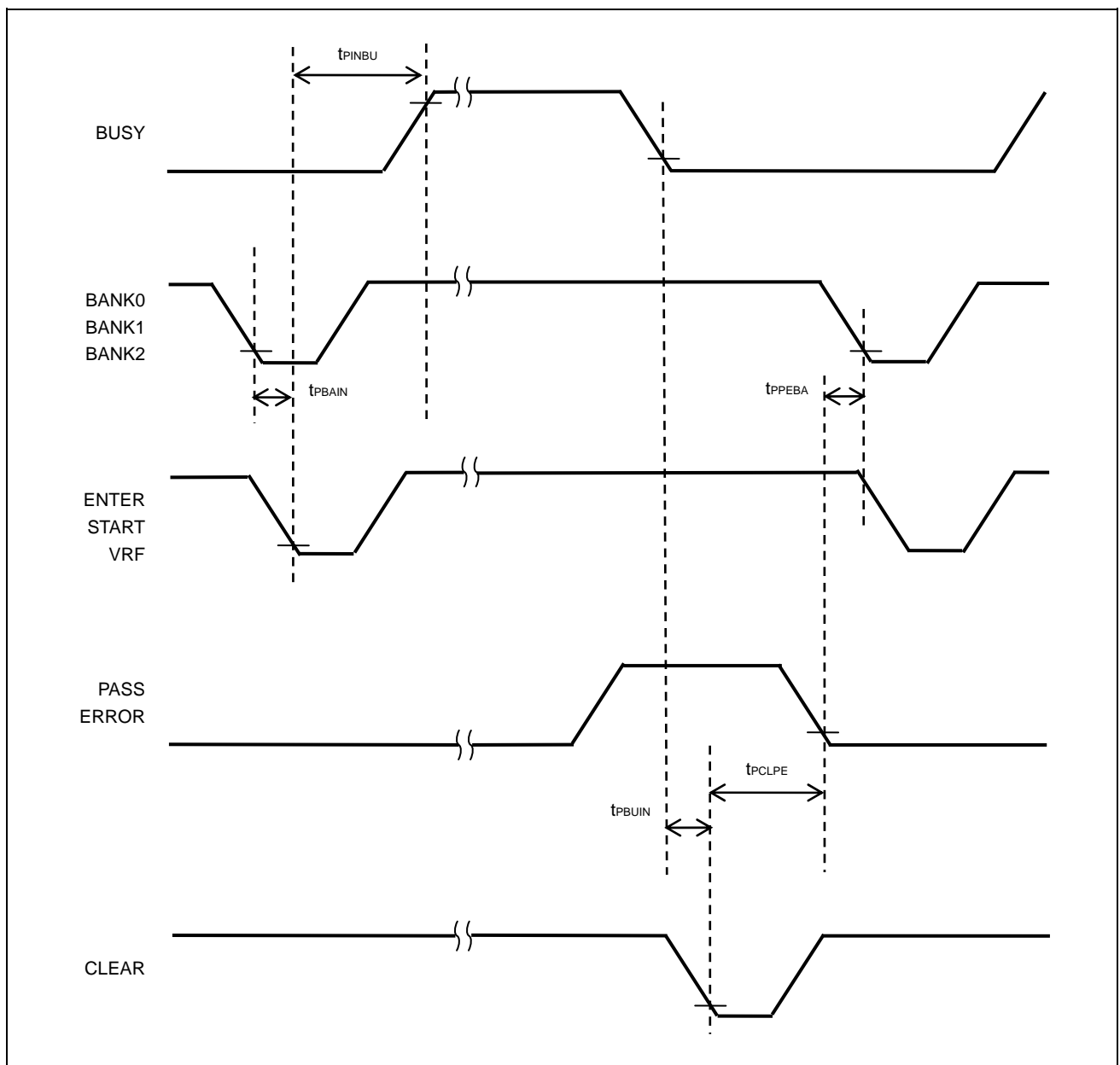

D.3.3 Simple mode

(1/2)

Pin name	Symbol	Parameter or Conditions	MIN.	TYP.	MAX.	Unit
CONN	t_{PLH}	Rise time ($I_o = 8\text{ mA}$)	5			ns
BUSY PASS ERROR	t_{PHL}	Fall time ($I_o = 8\text{ mA}$)	5			ns
CANCEL ENTER NEXT VRF START CLEAR	t_{PLIN}	Low-level width of input signal	50			ms
	t_{PPOCN}	Time from turning on the power of the FP5 until the rise of the CONN signal			15	s
	t_{PCNPO}	Time from turning off the power of the FP5 until the fall of the CONN signal			1	s
	t_{PCNIN}	Time from the rise of the CONN signal until the input signal is acknowledged	1			ms

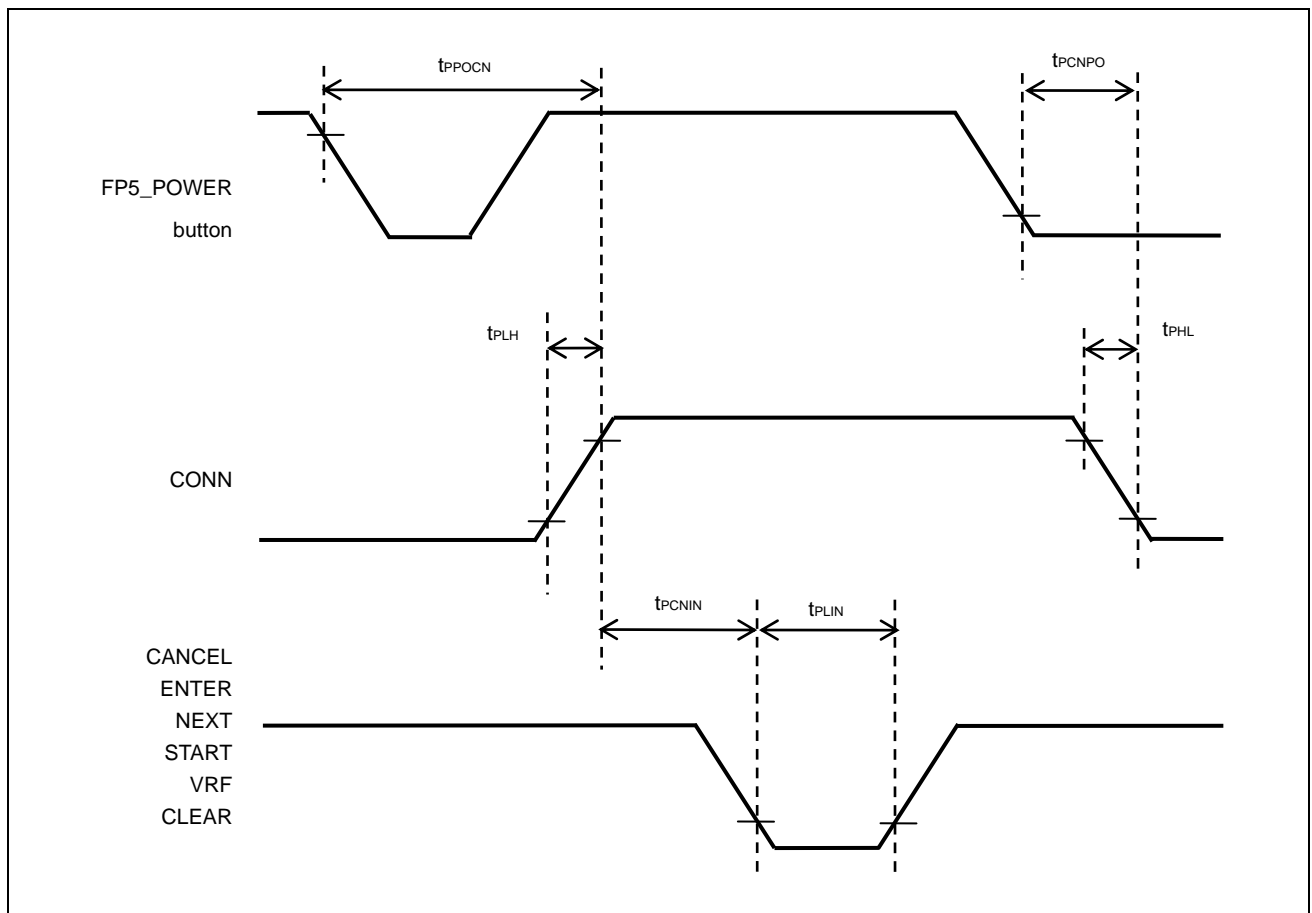

(2/2)

Pin name	Symbol	Parameter or Conditions	MIN.	TYP.	MAX.	Unit
	t _{PBAIN}	Time from the fall of the NEXT signal until the VRF or START signal can be input	1			ms
	t _{PINBU}	Time from the fall of the VRF, START or ENTER signal until the rise of the BUSY signal (When the input signal is input after having changed the program area)	5			ms
		Time from the fall of the VRF, START or ENTER signal until the rise of the BUSY signal (When the input signal is input without changing the program area)	50			ms
	t _{PBUIN}	Time from the fall of the BUSY signal until the CLEAR signal can be input	1			ms
	t _{PCLPE}	Time from the fall of the CLEAR signal until the fall of the PASS or ERROR signal	50			ms
	t _{PPENE}	Time from the fall of the PASS or ERROR signal until the NEXT signal can be input	1			ms

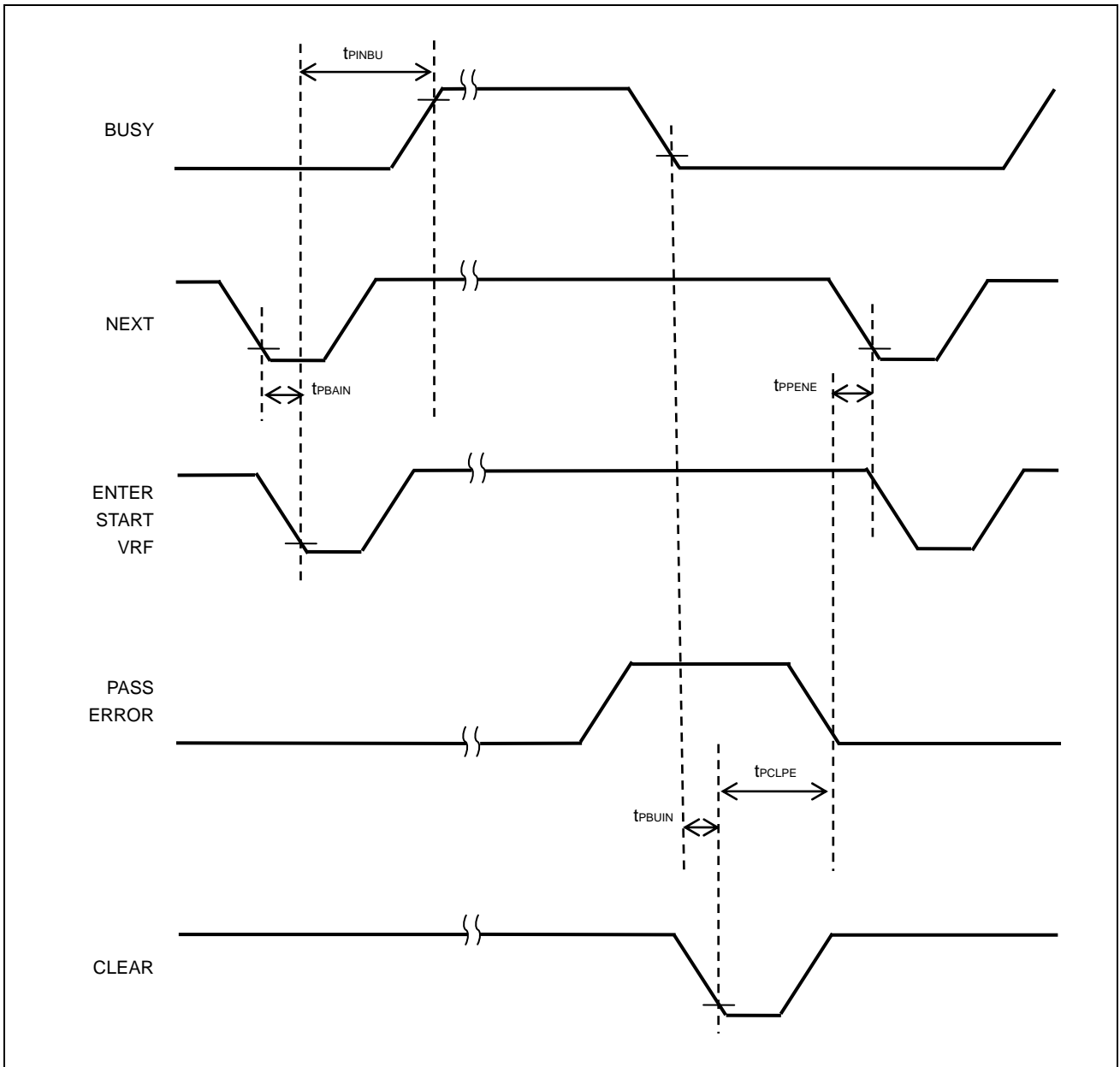

REVISION HISTORY

Revisions up to the previous edition are shown below. The “Applied to” column indicates the chapter in each edition to which the revision was applied.

(1/8)

Edition	Description	Applied to
2nd edition	1.5.2 Software environment <ul style="list-style-type: none"> • Addition of the Caution in (4) Program files 	CHAPTER 1 OVERVIEW
	2.3.1 FP5 control panel <ul style="list-style-type: none"> • Addition of the description in Remark 	CHAPTER 2 HARDWARE CONFIGURATION
	4.3.3 [Device] menu (12) (a) <5> [Information] area and Clear button <ul style="list-style-type: none"> • Change of the description in Clear button 	CHAPTER 4 PROGRAMMING GUI USAGE
	Figure 5-14. Device Setup Dialog Box - [Standard] Tab <ul style="list-style-type: none"> • Change of the description of [Communication Interface to device] area 	CHAPTER 5 EXAMPLE OF OPERATION USING PROGRAMMING GUI
	7.2 Remote Connector Pins <ul style="list-style-type: none"> • Change of the value 1 ms → 50 ms 	CHAPTER 7 USAGE THE REMOTE CONNECTOR
	Table 8-1. List of FP5 Control Commands <ul style="list-style-type: none"> • Deletion of the remote command • Change of the description of the ver command 8.4.6 fcks command <ul style="list-style-type: none"> • Change of the input format length → end 8.5.7 read command <ul style="list-style-type: none"> • Change of the description of function 	CHAPTER 8 USAGE COMMUNICATION COMMANDS
	C.1 Absolute Maximum Ratings (T_A = 0 to 40°C) <ul style="list-style-type: none"> • Addition of "+" or "±" in the rating value C.2 DC Characteristics (T_A = 0 to 40°C) <ul style="list-style-type: none"> • Addition of "-", "+", or "±" in the MAX. value 	APPENDIX C ELECTRICAL SPECIFICATIONS OF TARGET INTERFACE
	<ul style="list-style-type: none"> • Addition of APPENDIX D ELECTRICAL SPECIFICATIONS OF REMOTE INTERFACE 	APPENDIX D ELECTRICAL SPECIFICATIONS OF REMOTE INTERFACE
	<ul style="list-style-type: none"> • Addition of APPENDIX E REVISION HISTORY 	APPENDIX E REVISION HISTORY

Edition	Description	Applied to
3rd edition	Change of the URL of "Version-up Service"	Throughout
	1.4 FP5 System Overview <ul style="list-style-type: none"> • Change of description 	CHAPTER 1 OVERVIEW
	1.5.1 Hardware environment <ul style="list-style-type: none"> • Change of description 	
	1.5.2 Software environment <ul style="list-style-type: none"> • Change of description 	
	Table 1-1. Hardware Specifications <ul style="list-style-type: none"> • Change of description in specifications column 	
	Addition of 1.7 AC Adapters for PG-FP5	
	Addition of 1.8 HCUHEX Files	
	2.2.4 AC adapter <ul style="list-style-type: none"> • Change of description 	CHAPTER 2 HARDWARE CONFIGURATION
	2.3.1 FP5 control panel <ul style="list-style-type: none"> • Change of description 	
	Addition of 3.2.1 Notes on installation	CHAPTER 3 SOFTWARE INSTALLATION
	Figure 3-9. Action Log Window When Firmware Update Is Finished	
	Figure 3-13. Action Log Window When FPGA Update Is Finished Figure 3-16. Version Confirmation After FPGA Update Is Finished <ul style="list-style-type: none"> • Change of figures 	
	Figure 4-4. Main Window <ul style="list-style-type: none"> • Change of figure 	CHAPTER 4 PROGRAMMING GUI USAGE
	4.3 Menu Bar <ul style="list-style-type: none"> • Change of description 	
	4.3.1 [File] menu (1) [Hex Editor...] command <ul style="list-style-type: none"> • Change of description 	
	Figure 4-11. Checksum Result <If Downloaded PR5 File Is for Target Device That Does Not Support Data Flash>	
Figure 4-12. Checksum Result <If Downloaded PR5 File Is for Target Device That Supports Data Flash>		
Figure 4-24. Action Log Window When Firmware Update Is Finished		
Figure 4-27. Action Log Window When FPGA Update Is Finished		
Figure 4-30. Version Confirmation After FPGA Update Is Finished		
Figure 4-35. FP5 Manager Dialog Box		
Figure 4-38. [Device] Menu		
Figure 4-46. Clearing of Programming Area, PR5 Files and ESF Files, and Download of Program File		
Figure 4-81. Hint Bar <ul style="list-style-type: none"> • Change of figures 		

Edition	Description	Applied to		
3rd edition	4.3.2 [Programmer] menu (9) [FP5 Manager] command <ul style="list-style-type: none"> • Change of description 	CHAPTER 4 PROGRAMMING GUI USAGE		
	4.3.3 [Device] menu (6) [Set Security] command <ul style="list-style-type: none"> • Change of description 			
	4.3.3 [Device] menu <ul style="list-style-type: none"> • Addition of (9) [Set Option bytes] command, (10) [Set OCD Security ID] command, and (13) [Get Flash options] command 			
	4.3.3 [Device] menu (14) (a) <4> [Object HEX file] area <ul style="list-style-type: none"> • Change of description 			
	4.3.3 [Device] menu (14) (b) <1> [Communication interface to device] area, <3> [Operation Mode] area <ul style="list-style-type: none"> • Change of description 			
	4.3.3 [Device] menu (14) (c) [Advanced] tab in Device Setup dialog box Change of description <ul style="list-style-type: none"> • Change of description 			
	4.4 Toolbar <ul style="list-style-type: none"> • Change of description 			
	4.6 Programming Parameter Window <ul style="list-style-type: none"> • Change of description 			
			<ul style="list-style-type: none"> • Series of operations described in this chapter • Change of the description 	CHAPTER 5 EXAMPLE OF OPERATION USING PROGRAMMING GUI
			Figure 5-5. Main Window Figure 5-6. [Setup] Command Figure 5-16. Downloading of PR5 File, ESF File and Program File Figure 5-17. [Autoprocedure(E.P.) Command Figure 5-18. [Autoprocedure(E.P.) Command Execution Result <ul style="list-style-type: none"> • Change of figures 	
(8) System shutdown <ul style="list-style-type: none"> • Change of description 				
Table 6-1. [Commands] Menu Table 6-3. [Option Setting] Menu Table 6-4. [Voltage Setting] Menu <ul style="list-style-type: none"> • Change of tables 				
	Table 9-3. Target Connector Pin Configuration <ul style="list-style-type: none"> • Change of table 	CHAPTER 9 CONNECTORS AND CABLES		
	Addition of <4> I ² C to <6> V850 (Single-wire UART)	CHAPTER 10 NOTES ON TARGET SYSTEM DESIGN		

Edition	Description	Applied to
3rd edition	A.2 Error/Warning Dialog Boxes for Programming GUI Operation A.3 Information Dialog Boxes for Programming GUI Operation A.4 Error Messages Displayed in FP5 Message Display <ul style="list-style-type: none"> • Addition of messages 	APPENDIX A MESSAGES
	C.2 DC Characteristics (T_A = 0 to 40°C) <ul style="list-style-type: none"> • Change of V_{OL} and I_{LIL} • Addition of I_{LIH} 	APPENDIX C ELECTRICAL SPECIFICATIONS OF TARGET INTERFACE
4th edition	Change of the URL of "Version-up Service"	Throughout
	1.6 Hardware Specifications <ul style="list-style-type: none"> • Change of Table 1-1. Hardware Specifications 	CHAPTER 1 OVERVIEW
	4.3.1 [File] menu (2) [Upload from FP5...] command <ul style="list-style-type: none"> • Addition of Figure 4-9. [Upload from FP5...] Dialog Box in the HEX Editor (b) The uploaded file is for a target device that supports data flash 	CHAPTER 4 PROGRAMMING GUI USAGE
	Figure 4-37. Action Log Window <ul style="list-style-type: none"> • Change of the title 	
	4.3.3 [Device] menu <ul style="list-style-type: none"> • Change of the following figures <ul style="list-style-type: none"> Figure 4-45. [Get Flash options] Command Figure 4-64. Device Setup Dialog Box - [Advanced] Tab Figure 4-68. [Flash options] Area Figure 4-70. [Security flag settings] Area 	
	4.3.3 [Device] menu (14) [Setup] command (c) <5> [Security flag settings] area <ul style="list-style-type: none"> • Addition of Disable FSW re-setting 	
	CHAPTER 5 EXAMPLE OF OPERATION USING PROGRAMMING GUI <ul style="list-style-type: none"> • Change of Figure 5-15. Device Setup Dialog Box - [Advanced] Tab 	CHAPTER 5 EXAMPLE OF OPERATION USING PROGRAMMING GUI
	6.3.3 [Option Setting] menu <ul style="list-style-type: none"> • Change of Table 6-3. [Option Setting] Menu 	CHAPTER 6 USAGE IN STANDALONE MODE
	8.1 Starting the Communications Software (3) Start HyperTerminal <ul style="list-style-type: none"> • Addition of the Caution 	CHAPTER 8 USAGE COMMUNICATION COMMANDS
	9.1 Power Supply Connector <ul style="list-style-type: none"> • Change of the Caution 	CHAPTER 9 CONNECTORS AND CABLES
CHAPTER 10 NOTES ON TARGET SYSTEM DESIGN <ul style="list-style-type: none"> • Change of Figure 10-6. Circuit Example for V850 (Single-wire UART) 	CHAPTER 10 NOTES ON TARGET SYSTEM DESIGN	
A.4 Error Messages Displayed in FP5 Message Display <ul style="list-style-type: none"> • Change of No.091 (IVerify failed) 	APPENDIX A MESSAGES	

Edition	Description	Applied to
4th edition	C.1 Absolute Maximum Ratings ($T_A = 0$ to $40\text{ }^\circ\text{C}$) C.2 DC Characteristics ($T_A = 0$ to $40\text{ }^\circ\text{C}$) <ul style="list-style-type: none"> • Deletion of the GND item 	APPENDIX C ELECTRICAL SPECIFICATIONS OF TARGET INTERFACE
	C.2 DC Characteristics ($T_A = 0$ to $40\text{ }^\circ\text{C}$) <ul style="list-style-type: none"> • Change of the specifications of the I_{LIL} and I_{LIH} 	
	D.1 Absolute Maximum Ratings ($T_A = 0$ to $40\text{ }^\circ\text{C}$) D.2 DC Characteristics ($T_A = 0$ to $40\text{ }^\circ\text{C}$, $C = 0\text{ pF}$ (Unloaded Condition)) <ul style="list-style-type: none"> • Deletion of the GND item 	APPENDIX D ELECTRICAL SPECIFICATIONS OF REMOTE INTERFACE
5th edition	Change of the URL of "Flash Development Toolkit"	Throughout
	Change of the Terminology	How to Use This Manual
	1.3 Supported Devices <ul style="list-style-type: none"> • Change of description 	CHAPTER 1 OVERVIEW
	1.5.1 Hardware environment <ul style="list-style-type: none"> • Change of description 	
	1.5.2 Software environment <ul style="list-style-type: none"> • Change of description 	
	1.6 Hardware Specifications <ul style="list-style-type: none"> • Change of description 	
	1.8 HCUHEX Files <ul style="list-style-type: none"> • Change of description 	
	2.2.1 Host machine <ul style="list-style-type: none"> • Change of description 	
	2.2.5 Target cable <ul style="list-style-type: none"> • Change of description 	
	2.3.2 FP5 connectors <ul style="list-style-type: none"> • Change of description 	
	3.1 Obtaining Software <ul style="list-style-type: none"> • Change of description 	CHAPTER 3 SOFTWARE INSTALLATION
	3.2 Installation <ul style="list-style-type: none"> • Change of folder configuration 	
	3.2.1 Notes on installation <ul style="list-style-type: none"> • Change of description 	
	<ul style="list-style-type: none"> • Deletion of "3.2.2 Installation of USB driver" of 4th edition 	
	3.3 Uninstallation <ul style="list-style-type: none"> • Change of folder configuration 	
3.4.2 Installation of programming GUI <ul style="list-style-type: none"> • Change of description 		

Edition	Description	Applied to
5th edition	<p>3.4.3 Installation of firmware update</p> <ul style="list-style-type: none"> • Change of the following figures <p>Figure 3-6. [Update Firmware] Command</p> <p>Figure 3-9. Action Log Window When Firmware Update Is Finished</p>	CHAPTER 3 SOFTWARE INSTALLATION
	<p>3.4.4 Installation of FPGA update</p> <ul style="list-style-type: none"> • Change of the following figures <p>Figure 3-10. [Update FPGA] Command</p> <p>Figure 3-13. Action Log Window When FPGA Update Is Finished</p> <p>Figure 3-14. [Setup host connection] Command</p> <p>Figure 3-16. Version Confirmation After FPGA Update Is Finished</p>	
	<p>4.2 (3) Startup of programming GUI</p> <ul style="list-style-type: none"> • Change of description 	CHAPTER 4 PROGRAMMING GUI USAGE
	<p>4.3.1 [File] menu</p> <ul style="list-style-type: none"> • Change of description 	
	<p>4.3.2 [Programmer] menu</p> <ul style="list-style-type: none"> • Change of the following figures <p>Figure 4-13. [Programmer] Menu</p> <p>Figure 4-24. Action Log Window When Firmware Update Is Finished</p> <p>Figure 4-27. Action Log Window When FPGA Update Is Finished</p> <p>Figure 4-28. [Setup host connection] Command</p> <p>Figure 4-30. Version Confirmation After FPGA Update Is Finished</p>	
	<p>4.3.2 (9) [FP5 Manager] command</p> <ul style="list-style-type: none"> • Change of description 	
	<p>4.3.3 [Device] menu</p> <ul style="list-style-type: none"> • Change of description <p>(15) (c) [Advanced] tab in Device Setup dialog box</p> <p>Addition of <10> [Set Lock bits] area, <11> [Set I/O signals] area, and <12> [ID code] area</p>	
	<p>4.3.4 [Help] menu</p> <ul style="list-style-type: none"> • Change of description 	
	<p>4.6 Programming Parameter Window</p> <p>Change of Figure 4-84. Programming Parameter Window</p>	
	<p>4.8 Hint Bar</p> <p>Change of Figure 4-86. Hint Bar</p>	
	<p>(1) Installation of programming GUI and USB driver</p> <p>(3) System connection and installation of USB driver</p> <ul style="list-style-type: none"> • Change of description 	CHAPTER 5 EXAMPLE OF OPERATION USING PROGRAMMING GUI

Edition	Description	Applied to
5th edition	<ul style="list-style-type: none"> • Change of the following figures Figure 5-2. [Setup host connection] Command Figure 5-5. Main Window Figure 5-6. [Setup] Command Figure 5-7. Device Setup Dialog Box - [Target] Tab Figure 5-12. [Object HEX file] Area Figure 5-13. Selection of Program File Figure 5-15. Device Setup Dialog Box - [Advanced] Tab Figure 5-16. Downloading of PR5 File, ESF File and Program File Figure 5-17. [Autoprocedure(E.P.)] Command Figure 5-18. [Autoprocedure(E.P.)] Command Execution Result 	CHAPTER 5 EXAMPLE OF OPERATION USING PROGRAMMING GUI
	<ul style="list-style-type: none"> • Change of the following tables Table 6-1. [Commands] Menu Table 6-2. [Type Setting] Menu Table 6-3. [Option Setting] Menu 	CHAPTER 6 USAGE IN STANDALONE MODE
	<p>8.2 Command List</p> <p>Change of Table 8-2. List of FP5 Device Commands</p> <p>8.5.13 read command</p> <ul style="list-style-type: none"> • Change of description <p>8.5.14 scf command</p> <ul style="list-style-type: none"> • Change of description <ul style="list-style-type: none"> • Addition of 8.5.16 slb command <p>8.5.17 sum command</p> <ul style="list-style-type: none"> • Change of description 	CHAPTER 8 USAGE COMMUNICATION COMMANDS
	<p>9.4.1 Target Cable (16-pin type)</p> <ul style="list-style-type: none"> • Change of description <p>9.4.2 Target Cable (14-pin type)</p> <ul style="list-style-type: none"> • Change of description 	CHAPTER 9 CONNECTORS AND CABLES
	<ul style="list-style-type: none"> • Change of the following figures Figure 10-1. SIO-H/S Interface Circuit Example Figure 10-2. Circuit Example for 78K0S (Single-wire UART) Figure 10-3. Circuit Example for 78K0R (Single-wire UART) Figure 10-4. Circuit Example for I2C Figure 10-5. Circuit Example for 78K0 (TOOLCx, TOOLDx) <ul style="list-style-type: none"> • Addition of the followings <6> V850E2 (Single-wire UART) <7> V850E2 (CSI) <8> RL78 family (VDD = EVDD) <9> RL78 family (VDD ≠ EVDD) <10> RX family, SuperH family <11> R8C family 	CHAPTER 10 NOTES ON TARGET SYSTEM DESIGN

Edition	Description	Applied to
5th edition	11.2 SI/RxD and H/S <ul style="list-style-type: none"> • Change of description 	CHAPTER 11 SPECIFICATIONS OF TARGET INTERFACE CIRCUITS
	12.1 Problems During Startup <ul style="list-style-type: none"> • Change of description 	CHAPTER 12 TROUBLESHOOTING
	12.2 Problems During Operation <ul style="list-style-type: none"> • Change of description 	
	A.3 Information Dialog Boxes for Programming GUI Operation <ul style="list-style-type: none"> • Change of description 	APPENDIX A MESSAGES
	A.4 Error Messages Displayed in FP5 Message Display <ul style="list-style-type: none"> • Change of description 	
	APPENDIX B SUPPLEMENTARY INFORMATION <ul style="list-style-type: none"> • Change of Figure B-2. 32-bit CRC Calculation Specifications 	APPENDIX B SUPPLEMENTARY INFORMATION

PG-FP5 User's Manual

Publication Date: Rev.1.00 Nov 16, 2007
Rev.5.00 Dec 26, 2011

Published by: Renesas Electronics Corporation

**SALES OFFICES****Renesas Electronics Corporation**<http://www.renesas.com>Refer to "<http://www.renesas.com/>" for the latest and detailed information.

Renesas Electronics America Inc.
2880 Scott Boulevard Santa Clara, CA 95050-2554, U.S.A.
Tel: +1-408-588-6000, Fax: +1-408-588-6130

Renesas Electronics Canada Limited
1101 Nicholson Road, Newmarket, Ontario L3Y 9C3, Canada
Tel: +1-905-898-5441, Fax: +1-905-898-3220

Renesas Electronics Europe Limited
Dukes Meadow, Millboard Road, Bourne End, Buckinghamshire, SL8 5FH, U.K
Tel: +44-1628-585-100, Fax: +44-1628-585-900

Renesas Electronics Europe GmbH
Arcadiastrasse 10, 40472 Düsseldorf, Germany
Tel: +49-211-65030, Fax: +49-211-6503-1327

Renesas Electronics (China) Co., Ltd.
7th Floor, Quantum Plaza, No.27 ZhiChunLu Haidian District, Beijing 100083, P.R.China
Tel: +86-10-8235-1155, Fax: +86-10-8235-7679

Renesas Electronics (Shanghai) Co., Ltd.
Unit 204, 205, AZIA Center, No.1233 Lujiazui Ring Rd., Pudong District, Shanghai 200120, China
Tel: +86-21-5877-1818, Fax: +86-21-6887-7858 / -7898

Renesas Electronics Hong Kong Limited
Unit 1601-1613, 16/F., Tower 2, Grand Century Place, 193 Prince Edward Road West, Mongkok, Kowloon, Hong Kong
Tel: +852-2886-9318, Fax: +852-2886-9022/9044

Renesas Electronics Taiwan Co., Ltd.
13F, No. 363, Fu Shing North Road, Taipei, Taiwan
Tel: +886-2-8175-9600, Fax: +886 2-8175-9670

Renesas Electronics Singapore Pte. Ltd.
1 harbourFront Avenue, #06-10, keppel Bay Tower, Singapore 098632
Tel: +65-6213-0200, Fax: +65-6278-8001

Renesas Electronics Malaysia Sdn.Bhd.
Unit 906, Block B, Menara Amcorp, Amcorp Trade Centre, No. 18, Jln Persiaran Barat, 46050 Petaling Jaya, Selangor Darul Ehsan, Malaysia
Tel: +60-3-7955-9390, Fax: +60-3-7955-9510

Renesas Electronics Korea Co., Ltd.
11F., Samik Lavied' or Bldg., 720-2 Yeoksam-Dong, Kangnam-Ku, Seoul 135-080, Korea
Tel: +82-2-558-3737, Fax: +82-2-558-5141

PG-FP5