

Hybrid Fiberoptic Sensors FS-V11(P)/12(P)/10

Instruction Manual

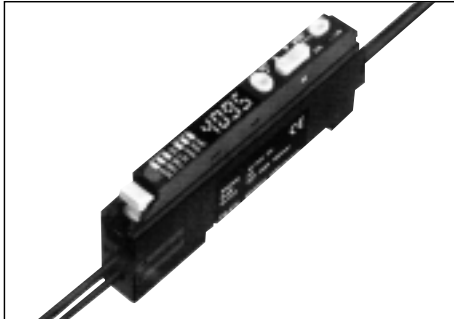

PART NAMES AND FUNCTIONS

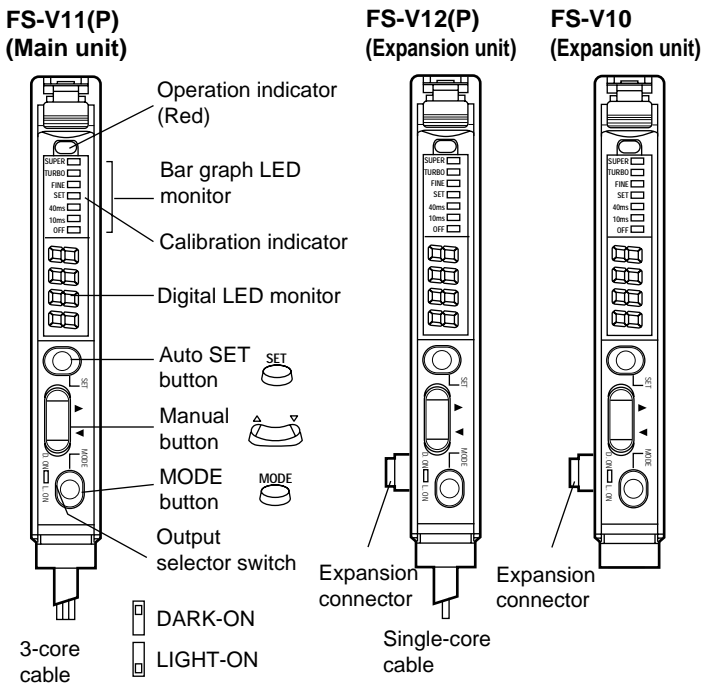

SAFETY PRECAUTIONS

! WARNING

- The FS-V11(P)/12(P)/10 are intended for target detection. Do not use the product in a safety circuit for protecting the human body.
- The FS-V11(P)/12(P)/10 are not explosion proof. Do not use the product in an environment in which inflammable gas, liquid or powder is present.

Accessories

- Instruction manual (x 1)
- Mounting bracket [FS-V11(P) only]
- Quick reference (x 1) [FS-V11(P) only]
- End unit (x 2) [FS-V12(P) only]
- Directions (x 1) [FS-V12(P) only]

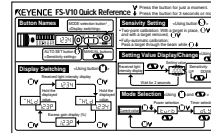
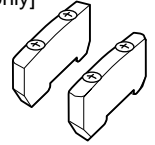
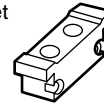

SPECIFICATIONS

Model	NPN output		FS-V11	FS-V12	FS-V10
	PNP output		FS-V11P	FS-V12P	—
Light source	Red LED				
Response time	250 μs (FINE)/500 μs (TURBO)/1 ms (SUPER)			410 μs to 1.7 ms ¹	
Operation mode	LIGHT-ON/DARK-ON (switch-selectable)				
Indicators	Output indicator: Red LED Digital LED monitor: Red LED Bar graph LED monitor: Green/Orange LED ² Calibration indicator: Orange LED ²				
Timer function	OFF-delay: 40 ms, 10 ms Timer OFF (switch selectable)				
Control output	NPN or PNP open-collector 100 mA max. (40 V max.), Residual voltage: 1 V max.				
Protection circuit	Reverse polarity protection, Over-current protection, Surge absorber				
Power supply voltage	12 to 24 VDC ±10%, Ripple (P-P) 10% max.				
Current consumption	50 mA max.				
Ambient illumination	Candescant lamp: 10,000 lx max., Sunlight: 20,000 lx max				
Ambient temperature	-10 to +55°C ³				
Relative humidity	35 to 85%				
Vibration	10 to 55 Hz, 1.5 mm double amplitude in X, Y and Z directions for two hours				
Shock immunity	500 m/s ² in X, Y and Z directions, three times each				
Housing material	Body/Cover: Polycarbonate				
Weight (including 2-m cable)	Approx. 80 g	Approx. 45 g	Approx. 20 g		

1. The response time varies depending on the number of expansion units connected.
2. The orange LED is normally part of the bar graph LED monitor. It is used as a calibration indicator during the setting of the sensitivity.
3. When several units are connected, the allowable ambient temperature changes depending on the following conditions. To connect several units, be sure to mount them to a DIN rail (metal DIN rail). Make sure that the output current is 20 mA max.
 - When 3 to 10 units are connected: -10 to +50 °C
 - When 11 to 16 units are connected: -10 to +45 °C

SELECTING DISPLAYED DATA

The display changes every time the MODE button is pressed.

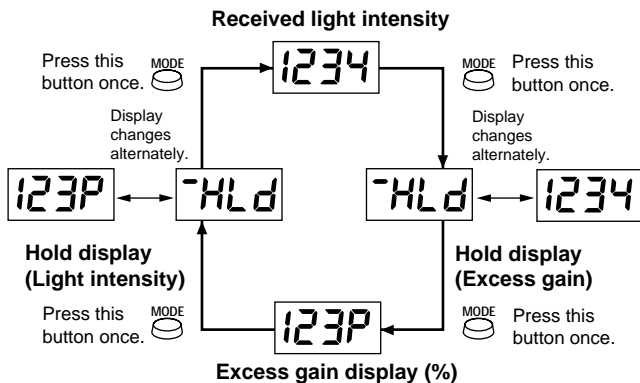

Displaying the setting value

Press or once while the received light intensity is displayed. The setting value flashes for 2 seconds, and then the received light intensity appears once more.

Note: To change the setting value, press or while the setting value is flashing.

■ Displaying received light intensity

Received light intensity is displayed approximately 4000 is the maximum setting.

Note: The MAX and MIN values vary depending on the fiber unit connected.

■ Displaying excess gain

Received light intensity is converted by defining the setting value as 100 P (%).

- Stable LIGHT status is obtained with 110 P (%) or more.
- Stable DARK status is obtained with 90 P (%) or less.

■ Displaying the hold value

The peak value or the minimum value of the received light intensity or excess gain is displayed.

The setting of the output selector switch determines whether the peak value or the minimum value is displayed.

Output selector switch	Display	Hold value
LIGHT-ON	-HLd	Peak-hold value
DARK-ON	-HLd	Bottom-hold value

SETTING THE SENSITIVITY (AUTOMATIC CALIBRATION)

Select the sensitivity setting procedure according to the target condition.

When the setting is completed, the setting value flashes twice.

For sensitivity adjustment using a moving target

Fully-automatic Calibration

1. Pass a target through the optical axis while pressing the SET button.
2. Confirm that the calibration indicator (orange LED) flashes.
3. Release the SET button. (The orange LED goes off.)

The setting value is adjusted to the midpoint of the difference between the maximum and minimum values of the received light intensity.

If the fully-automatic calibration does not work properly, try the two-point calibration.

For sensitivity adjustment using a stationary target

Two-point Calibration

1. With no target in place, press the SET button and release it. (The orange LED lights.)
2. Position a target in place. Press the SET button again and release it. (The orange LED goes off.)

The setting value is adjusted to the midpoint of the difference in the received light intensity when the target is absent and present.

For target positioning

Positioning Calibration

1. With no target, press the SET button and release it. (The orange LED lights.)
2. Place a target in the position where it is to be stopped.
3. Press the SET button for 3 seconds or more until the calibration indicator (orange LED) flashes. Release the SET button. (The orange LED goes off.)

The setting value is adjusted to turn on the sensor when the target comes to the place where it should be stopped.

For maximum sensitivity

Maximum sensitivity setting

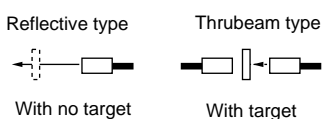

When the reflective type is used to detect a target with some objects in the background, the sensitivity is set to the maximum value at which the background objects are not detected.

If the detecting distance is insufficient, try the two-point calibration.

1. Under the conditions on the left, press the SET button for 3 seconds or more.
2. Confirm that the calibration indicator (orange LED) flashes.
3. Release the SET button. (The orange LED goes off.)

CHANGING THE SETTING VALUE (MANUAL CALIBRATION)

Use the button.

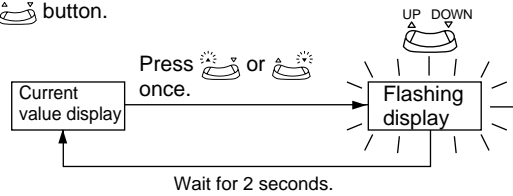

Received light intensity display

Press or once. The setting value flashes. Change the setting value by pressing or while the value is flashing.

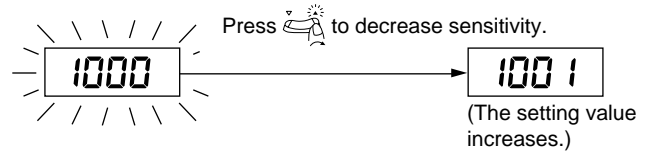
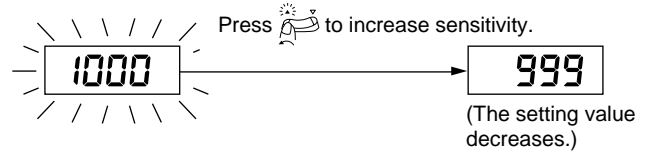

The current value appears after 2 seconds.*

Excess gain display

Press or once. The setting value flashes. Change the setting value by pressing or while the value is flashing.

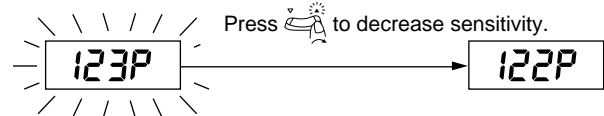
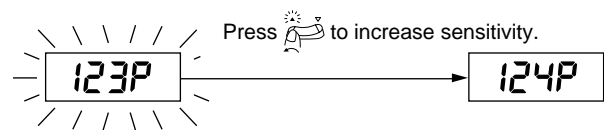

The current value appears after 2 seconds.*

Note: If the SET button is pressed by accident while the sensitivity is being manually changed, the automatic sensitivity setting will start (The calibration indicator lights.). The sensitivity cannot be changed until the automatic sensitivity setting is completed (The calibration indicator goes off.).

* Do not press any buttons other than the manual button while the setting value is flashing. Otherwise, the value cannot be changed properly.

When the sensitivity difference is insufficient

If the sensitivity has no allowance, " - - - " flashes immediately after the completion of the automatic calibration.

Note: Sensitivity is set and entered even when the sensitivity difference is insufficient. Be sure to confirm that the detection is properly performed.

Locking the operation button

Hold down and [MODE] or and [MODE] simultaneously for 3 seconds or more to lock the operation buttons. When "LoL" is displayed in flashing letters, the buttons are locked.

To unlock the operation buttons, repeat the procedure above. When "uNL" is displayed in flashing letters, the buttons are unlocked. Even when the operation buttons are locked, you can change the display data or output method, or display the setting value.

SELECTING MODE (POWER/TIMER)

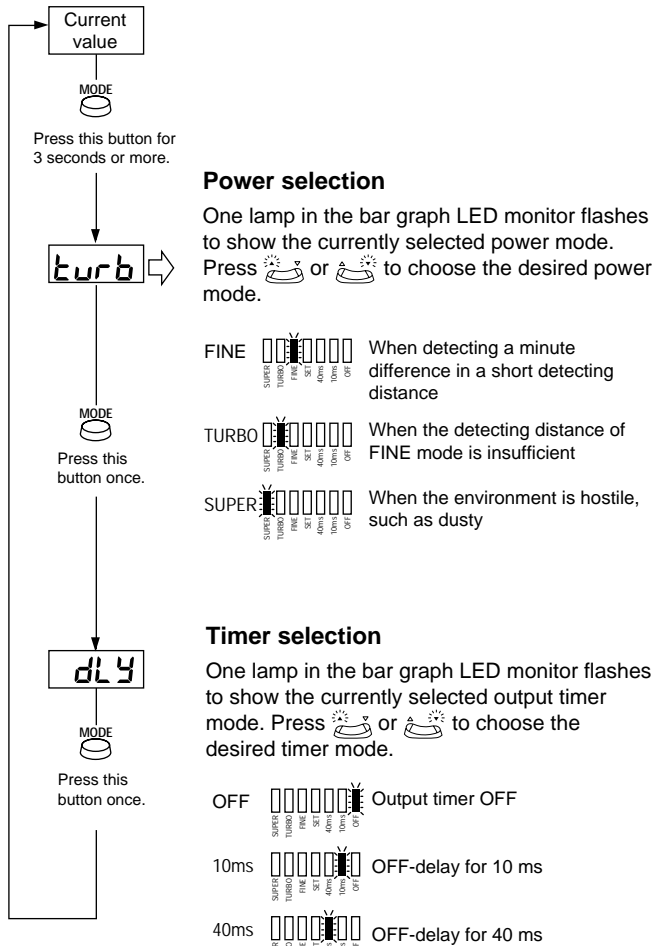

Note: Be sure to readjust the sensitivity after the power mode is changed.

Bar graph LED monitor in normal operation

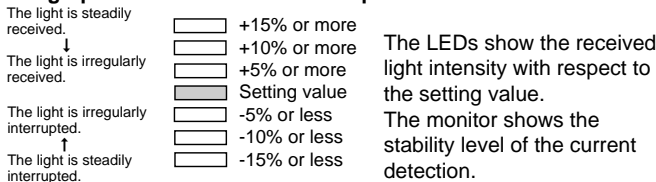

When the detection becomes unstable due to the change in surrounding environment or targets, readjust sensitivity.

MUTUAL INTERFERENCE SUPPRESSION FUNCTION

When several expansion units are connected, each fiber unit is free from light interference from the adjacent fiber units.

The number of fiber units that are free from light interference depends on the selected power mode.

Power mode	FINE	TURBO	SUPER
No. of units free from interference	4	8	

Note: When units are not connected using the expansion connectors, the mutual interference suppression function does not work. The mutual interference suppression function is limited to 4 units even if only one unit is set to FINE mode.

MOUNTING UNIT AND SEVERAL UNITS

Mounting/Detaching the unit to/from a DIN rail or the mounting bracket.

Hook the claw located at the unit cable side onto the DIN rail, and then hook the front side claw to the rail while pressing the amplifier forward. To detach the unit, unhook the front claw by lifting the unit front side while pressing it forward.

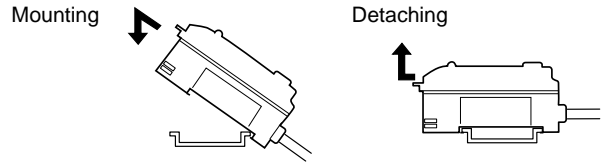

Mounting a unit laterally

Secure the unit with screws through the side holes of the supplied mounting bracket [FS-V11(P) only].

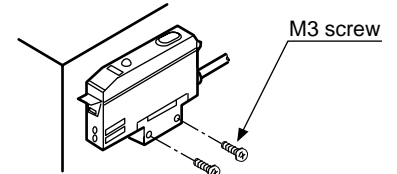

MOUNTING UNIT AND SEVERAL UNITS

Mounting several units

1. Detach the protective cover from the unit's side panel.
2. Mount units to a DIN rail one by one.
3. Slide one expansion unit toward another. Align the front claws of the units and push the unit together until they click.
4. Fix the units together by pushing an end unit onto each end. [The end units are included in the FS-V12(P)]

Detaching units from DIN rail

1. Remove the end units.
2. Slide the expansion units apart, and detach them individually. (Do not detach multiple units connected together with end units.)

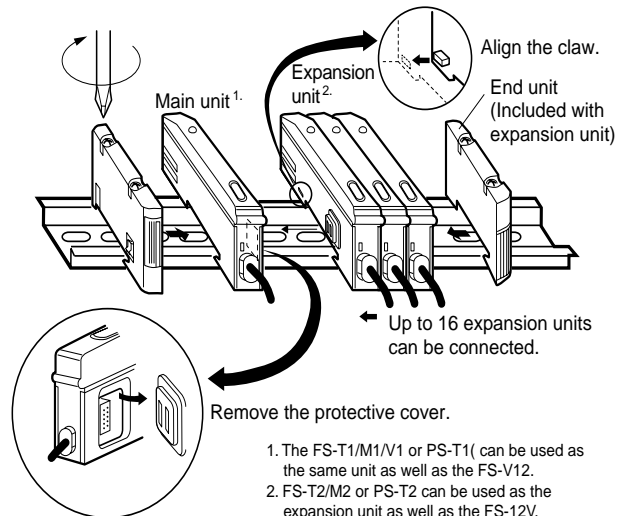

1. The FS-T1/M1/V1 or PS-T1(can be used as the same unit as well as the FS-V12.
2. FS-T2/M2 or PS-T2 can be used as the expansion unit as well as the FS-12V.

The sticker shown on the right is included in the expansion unit. Apply this sticker near the sensor.



- Note 1:** When several units are connected, confirm the ambient temperature. (See "Specifications" on P. 1.)
- Note 2:** To connect several units, be sure to use a DIN rail and end units.
- Note 3:** To mount or detach several units, be sure to turn the power off.
- Note 4:** Do not remove the protective cover of the expansion connector on the outmost unit.

I/O CIRCUIT

NPN FS-V11

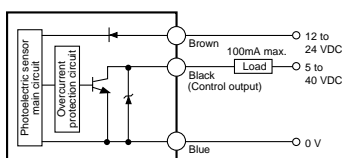

FS-V12

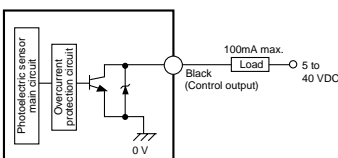

PNP FS-V11P

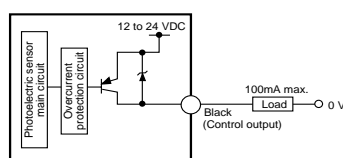

FS-V12P

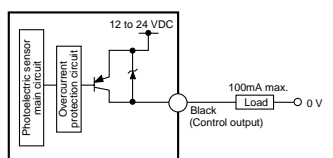

CONNECTING FIBER UNIT

Lower the quick-release lever, insert the fiber unit about 14 mm until it reaches the end, and then lift the quick-release lever.

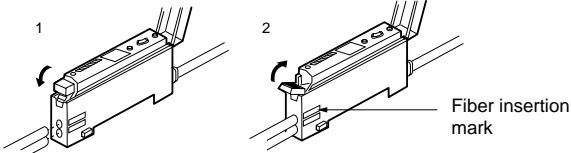

To connect a fiber unit with a small diameter, use the adaptor included with the FU series.

1. Attach the adaptor to the fiber unit.
2. Fully insert the adaptor into the mounting holes of the amplifier, and then lift the quick-release lever.

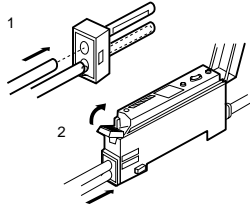

Note: If the fiber unit is improperly connected, the sensor cannot meet the specifications.

- The required adaptor is included in each model of the FU series. If an inadequate adaptor is used, the fiber unit cannot be properly installed.

Type	Shape	Applicable fiber unit
Adaptor A (OP-26500)	For 1.3 mm diameter	FU-32/35FA/35FZ/4F/4FZ/43/63/63T/63Z/66/66Z/78/91/93
Adaptor B (OP-26501)	For 1 mm diameter	FU-16/18/31/37/38/38V/48/59/68/75F/79/95

- To connect the coaxial reflective type fiber unit to the amplifier, connect the single-core fiber to the transmitter side, and connect the multiple-core fiber to the receiver side. (Connect the fibers according to the marking on the amplifier lateral side.)

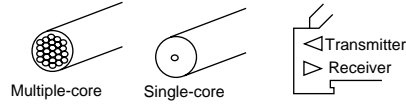

DIMENSIONS

Unit: mm

FS-V11(P)

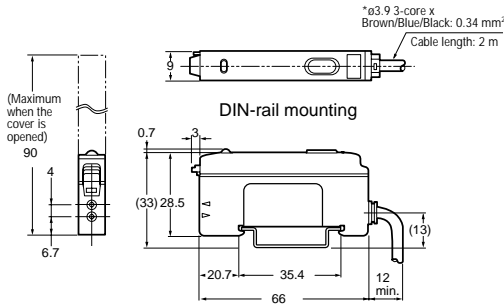

When the mounting bracket [included in FS-V11(P)] is attached:

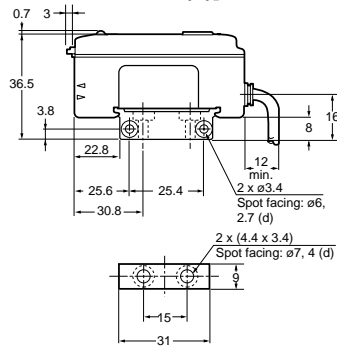

FS-V12(P)

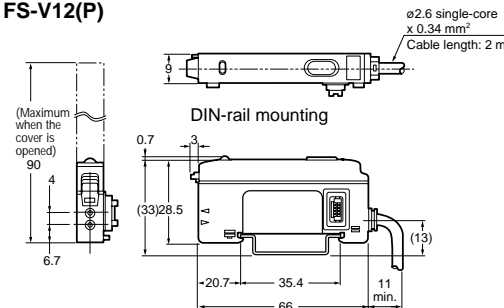

End unit [included in FS-V11(P)]

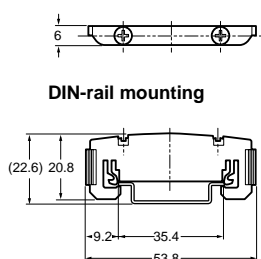

FS-V10

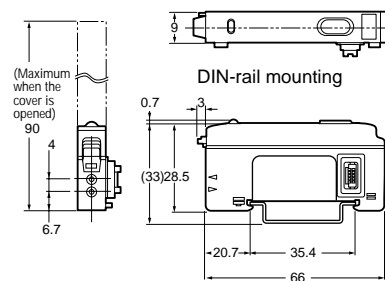

When several units are connected:

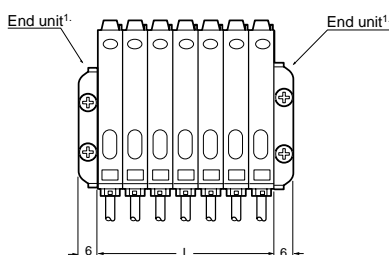

No. of units	L
1	9
2	18
3	27
4	36
5	45
6	54
7	63
8	72
9	81
10	90
11	99
12	108
13	117
14	126
15	135
16	144
17	153

Note: Be sure to use the end units to connect to the expansion units.

HINTS ON CORRECT USE

- To extend the cable length, use a cable with at least a 0.3 mm² cross-section area. Limit the length of cable extension to no more than 100 m. (To connect several units, contact Keyence for further information.)
- If the amplifier cable is placed together with power lines or high voltage lines in the same conduit, detection error may occur due to noise interference, or the sensor may be damaged. Isolate the amplifier cable from these lines.
- When using a commercially available switching regulator, ground the frame ground terminal and ground terminal.
- Do not use the FS series outdoors, or in a place where extraneous light can enter the light receiving surface directly.
- During maximum sensitivity setting, the detecting distance may vary due to the difference in characteristics of each unit.
- Improper wiring may cause the amplifier to become hot or may change the sensitivity.
- The displayed value may vary depending on the surrounding environment (change in temperature, dust, etc.).

KEYENCE

Worldwide Headquarters
KEYENCE CORPORATION
 1-3-14, Higashi-Nakajima, Higashi-Yodogawa-ku,
 Osaka, 533-8555, Japan
 PHONE: 81-6-6379-2211 FAX: 81-6-6379-2131

KEYENCE CORPORATION OF AMERICA
 PHONE: 201-930-0100 FAX: 201-930-0099

KEYENCE (UK) LIMITED
 PHONE: 01908-696900 FAX: 01908-696777

KEYENCE DEUTSCHLAND GmbH
 PHONE: 0711-797371-0 FAX: 0711-7977799

KEYENCE FRANCE S.A.
 PHONE: 01 47 92 76 76 FAX: 01 47 92 76 77

KEYENCE SINGAPORE PTE LTD
 PHONE: 392-1011 FAX: 392-5055

KEYENCE (MALAYSIA) SDN BHD
 PHONE: 03-252-2211 FAX: 03-252-2131

KEYENCE (THAILAND) CO., LTD
 PHONE: 02-934-6777 FAX: 02-934-6775

KEYENCE KOREA CORPORATION
 PHONE: 02-563-1270 FAX: 02-563-1271