

**EM MINI BASIC, 220 – 240 V 50/60 Hz**

BASIC version

**Product description**

- \_ Emergency lighting supply unit for manual testing
- \_ For compact fluorescent lamps
- \_ Small dimensions (28 x 40 mm cross-section, 150 mm length)
- \_ 5-year guarantee

**Properties**

- \_ 3 h rated duration
- \_ Compatible with all electronic ballasts (dimmable and non-dimmable)
- \_ Can also be used in combination with conventional magnetic ballasts
- \_ 5-pole technology: 4-pole lamp changeover and delayed power switching for the ballast
- \_ Switchover relay with high-current contacts
- \_ IDC (insulation displacement connection)
- \_ Green charge status display LED
- \_ Checking the emergency lighting function by interrupting the unswitched phase
- \_ Deep discharge protection
- \_ Short-circuit-proof battery connection
- \_ Polarity reversal protection for battery

**Batteries**

- \_ High-temperature cells
- \_ NiCd batteries
- \_ D cells
- \_ Blade terminals for simple connection
- \_ 4-year design life
- \_ 1-year guarantee

**Website**

<http://www.tridonic.com/89899951>



**EM MINI BASIC, 220 – 240 V 50/60 Hz**

BASIC version

The complete data sheet for this product is available in the Downloads section.

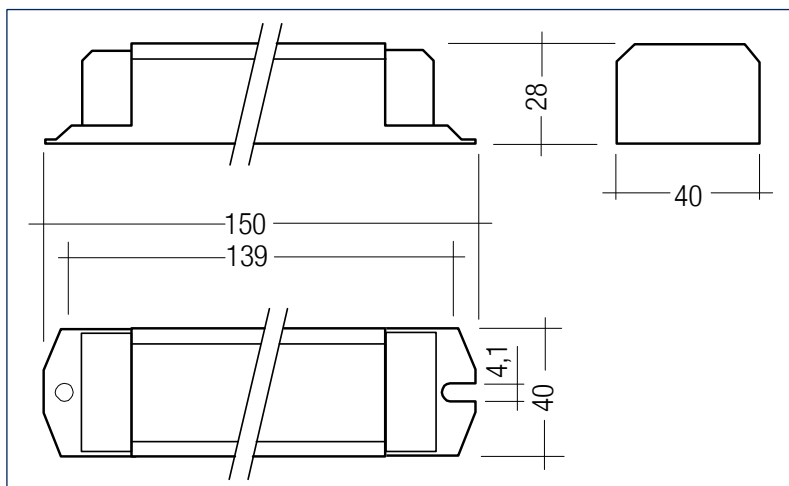
**Ordering data**

Type	Article number	Number of cells	Packaging, carton	Packaging, pallet	Weight per pc.
<b>Rated operating time 3 h</b>					
EM 33A MINI BASIC	89899951	3	25 pc(s).	1,000 pc(s).	0.155 kg

**Technical data**

Rated supply voltage	220 – 240 V
Mains frequency	50 / 60 Hz
Mains current	0.03 A
Rated power	3.9 W
Battery charging time	24 h
Discharge current <sup>①</sup>	1.1 A
Charge current <sup>①</sup>	210 mA
Leakage current (PE)	0.5 mA
Ambient temperature $t_a$	0 ... +60 °C
Max. casing temperature $t_c$	70 °C
Mains voltage changeover threshold	According to EN 60598-2-22
Min. lamp starting temperature (emergency mode)	0 °C
Type of protection	IP20

**Approval marks****Standards**

Acc. to EN 50172, Acc. to EN 60598-2-22, EN 61347-2-7, EN 55015, EN 61000-3-2, EN 61000-3-3, EN 61547, EN 60068-2-29, EN 60068-2-30, EN 60068-2-64

① Tolerance  $\pm 15\%$  at 230 V